

# 2013 WIKA Price List

## Pressure and Temperature Measurement



- Mechanical Pressure
- Electronic Pressure
- Diaphragm Seals
- Mechanical Temperature
- Accessories



# 2013 WIKA Price List

## Pressure and Temperature Measurement

### 2013 WIKA Price List

**Mechanical Pressure**  
**Electronic Pressure**  
**Diaphragm Seals**  
**Mechanical Temperature**  
**Accessories**

Effective January 1, 2013

#### **TERMS AND CONDITIONS**

Terms and Conditions of Sale and Return Material Authorizations (RMA) are available from the WIKA website at [www.wika.com](http://www.wika.com). Prices are subject to change without prior notice.

#### **PRODUCT SPECIFICATIONS**

The 2013 WIKA Price List supersedes all previous price lists. Product specifications are subject to change without prior notice. Please visit the WIKA website for the most up-to-date information.

Printed in the United States of America

**WIKAI**<sup>®</sup> is a registered trademark of WIKA Instrument LP, Lawrenceville, GA

 is a registered trademark of Underwriter's Laboratories.

 is a registered trademark of Underwriter's Laboratories.

XSEL<sup>®</sup> is a registered trademark of WIKA Instrument LP.

air2guide<sup>™</sup> is a registered trademark of WIKA Instrument LP.

Halocarbon<sup>®</sup> is a registered trademark of the Halocarbon Products Corporation.

Hastelloy<sup>®</sup> is a registered trademark of the Cabot family of companies.

Fluorolube<sup>®</sup> is a registered trademark of the Hooker Chemical & Plastics Corporation.

Monel<sup>®</sup> and Inconel<sup>®</sup> are registered trademarks of the INCO family of companies.

Viton<sup>®</sup> & Teflon<sup>®</sup> are registered trademarks of the E.I. DuPont family of companies.

Lexan<sup>®</sup> is a registered trademark of SABIC Innovative Plastics.

List Prices Effective, January 1, 2013

|   |   |
|---|---|
| Selecting a Pressure Gauge .....              | 5 |
| Chemical Compatibility Chart .....            | 6 |
| Advantages of Liquid-Filled Gauges .....      | 7 |
| WIKA Type Numbers.....                        | 8 |
| Ordering Guidelines for Pressure Gauges ..... | 9 |

## MECHANICAL PRESSURE

### General Purpose

|                               |                         |    |
|-------------------------------|-------------------------|----|
| 111.10 1½", 2", 2½", 4" ..... | ABS Case, Lower mount   | 10 |
| 111.12 1½", 2", 2½".....      | ABS Case, Back mount    | 15 |
| 111.11RF 2½".....             | Refrigeration Gauges    | 19 |
| 111.10SP 4".....              | Fire Sprinkler Gauges   | 20 |
| 111.11 1½", 2", 2½".....      | Compressed Gas Gauges   | 21 |
| 111.16PM 1½", 2".....         | ABS Case, Panel Mount   | 23 |
| 111.25CT 4½".....             | Contractor's Gauge      | 25 |
| 113.13 1½", 2½".....          | ABS Case, Liquid-filled | 27 |
| 113.53 1½".....               | SS Case, Liquid-filled  | 29 |

### Industrial & Process Gauges

|                              |                                  |    |
|------------------------------|----------------------------------|----|
| 131.11 1½", 2".....          | SS Case, Small Diameter          | 31 |
| 13X.53 4".....               | Economy 4" Brass Gauges          | 33 |
| 211.11 10".....              | SS Case, 10" Size                | 35 |
| 212.20 6".....               | SS Case, General Industrial      | 37 |
| 213.40 2½", 4".....          | Forged Brass Case, Liquid-filled | 39 |
| 21X.40PM 3½".....            | Paper Machine Gauges             | 41 |
| 21X.53 2", 2½", 4".....      | Utility Gauge, Liquid-fillable   | 43 |
| 23X.53 2", 2½", 4".....      | SS Gauge, Liquid-fillable        | 47 |
| 23X.54 2½", 4".....          | SS Case, Bayonet Ring            | 51 |
| 232.54 XMAS.....             | Oilfield Xmas Tree Gauges        | 53 |
| 232.54 Receiver.....         | SS Gauge with Receiver Scales    | 53 |
| 233.55 2½".....              | SS Panel Builder Gauges          | 55 |
| 23X.30 2½", 4", 4½".....     | SS Solid Front Gauges            | 57 |
| 23X.50 2½", 4", 4½", 6"..... | SS Industrial Gauges             | 61 |
| 21X.34 4½".....              | XSEL® Process Gauge, Brass       | 65 |
| 22X.34 4½".....              | XSEL® Process Gauge, 1019 Steel  | 66 |
| 23X.34 4½", 6".....          | XSEL® Process Gauge, 316SS       | 67 |
| 26X.34 4½".....              | XSEL® Process Gauge, Monel®      | 68 |
| 232.34DD 4½".....            | Direct-Drive Process Gauges      | 70 |
| 212.25 4½", 6".....          | Hinged Ring Gauges, Brass        | 72 |
| 232.25 4½", 6".....          | Hinged Ring Gauges, SS           | 72 |
| 4X2.12 4".....               | Sealgauges                       | 74 |
| 43X.50 4".....               | Sealgauges                       | 75 |

### Low Pressure Gauges

|                 |                             |    |
|-----------------|-----------------------------|----|
| A2G-10 4½"..... | air2guide™ gauges           | 76 |
| A2G-15 4½"..... | air2guide™ gauges           | 76 |
| 611.10 2½"..... | Low Pressure Gauges, Brass  | 78 |
| 612.20 4".....  | Low Pressure Gauges, Brass  | 79 |
| 632.50 4".....  | Low Pressure Gauges, SS     | 80 |
| 612.34 4½"..... | Low Pressure Process Gauges | 82 |
| 632.34 4½"..... | Low Pressure Process Gauges | 82 |

### Differential & Duplex Gauges

|                       |  |    |
|-----------------------|--|----|
| 700.04 2½", 4½".....  | Differential Pressure Gauges – Piston Type             | 84 |
| 700.05 2½", 4½".....  | Differential Pressure Gauges – Piston Type             | 86 |
| 712.15 6".....        | Cryogenic Liquid Level Gauges                          | 88 |
| 712.25DP 4½", 6"..... | Differential Pressure Gauges – Bourdon Tube Type       | 90 |
| 712.25DX 4½", 6"..... | Duplex Pressure Gauges – Dual Pointers                 | 92 |
| 732.25 4½", 6".....   | Differential Pressure Gauges for High Static Pressures | 94 |
| 732.26 4½", 6".....   | Differential Pressure Gauges for High Static Pressures | 94 |

For complete detailed information, including electronic pressure, electronic temperature and ultra high purity products, please visit [www.wika.com](http://www.wika.com).

List Prices Effective, January 1, 2013

|                                       |   |     |
|---------------------------------------|---|-----|
| <b>High Precision Gauges</b>          |   |     |
| 312.20 6" .....                       | ±0.25% Accuracy, Brass                        | 96  |
| 332.30 6" .....                       | ±0.25% Accuracy, SS                           | 96  |
| 332.54 4" .....                       | ±0.25% Accuracy, SS                           | 98  |
| 332.34 4½" .....                      | ±0.25% Accuracy, Process Gauges               | 100 |
| 332.25 4½" .....                      | ±0.25% Accuracy, Hinged Ring Gauges           | 102 |
| 332.34DD 4½" .....                    | ±0.25% Accuracy, Direct Drive Gauges          | 104 |
| 342.11 10" .....                      | ±0.10% Accuracy, NiSpanC Gauges               | 106 |
| <b>Calibration Equipment</b>          |   |     |
| CPG 1000 .....                        | Digital Test Gauges                           | 108 |
| WICP-L100, WICP-M500, WICP-H10K ..... | Pressure Calibrators                          | 109 |
| CPH6600 .....                         | Handheld Pressure Calibrators                 | 110 |
| <b>ELECTRONIC MEASUREMENT</b>         |   |     |
| <b>General Purpose</b>                |   |     |
| S-10 .....                            | Standard Industrial                           | 111 |
| S-11 .....                            | Standard Industrial, Flush Diaphragm          | 115 |
| F-20 .....                            | Field Case, NEMA 4X                           | 119 |
| F-21 .....                            | Field Case, NEMA 4X, Flush Diaphragm          | 122 |
| C-10 .....                            | Compact Design                                | 125 |
| A-10 .....                            | All Purpose Design                            | 129 |
| OT-1 .....                            | OEM Industrial                                | 132 |
| DG-10 .....                           | Digital Gauge                                 | 134 |
| PSD-30 .....                          | Pressure Switch with Display                  | 137 |
| TSD-30 .....                          | Temperature Switch with Display               | 140 |
| LSD-30 .....                          | Liquid Level Switch with Display              | 142 |
| <b>Hazardous Area</b>                 |   |     |
| E-10 .....                            | Explosion-proof                               | 143 |
| E-11 .....                            | Explosion-proof, Flush Diaphragm              | 146 |
| N-10 .....                            | Non-incendive                                 | 149 |
| N-11 .....                            | Non-incendive, Flush Diaphragm                | 152 |
| IS-20, IS-20-F .....                  | Intrinsically-safe                            | 155 |
| IS-21, IS-21-F .....                  | Intrinsically-safe, Flush Diaphragm           | 159 |
| IS-20-VR .....                        | Intrinsically-safe, Vapor Recovery            | 163 |
| <b>Submersible Liquid Level</b>       |   |     |
| LS-10 .....                           | Liquid Level Submersible                      | 164 |
| LH-10 .....                           | Liquid Level Submersible, High Performance    | 165 |
| IL-10 .....                           | Liquid Level Submersible, Intrinsically-safe  | 168 |
| <b>Special Purpose</b>                |   |     |
| MH-2 .....                            | OEM, Mobile Hydraulics                        | 170 |
| UT-10, IUT-10 .....                   | Unitrans, Intrinsically-safe                  | 172 |
| UT-11, IUT-11 .....                   | Unitrans, Intrinsically-safe, Flush Diaphragm | 174 |
| HP-2 .....                            | High Pressure                                 | 176 |
| P-30 .....                            | High Precision                                | 178 |
| P-31 .....                            | High Precision, Flush Diaphragm               | 180 |
| R-1 .....                             | OEM, Refrigeration                            | 182 |
| AC-1 .....                            | OEM, HVAC                                     | 184 |
| TTF-1 .....                           | OEM, Thin Film Sensor                         | 186 |
| <b>Meters &amp; Displays</b>          |   |     |
| A-AI-1 .....                          | Attachable Loop Indicator                     | 187 |
| DI-15 .....                           | Digital Indicator                             | 187 |
| <b>3A Sanitary</b>                    |   |     |
| S-10-3A .....                         | S-10 with Sanitary Seal                       | 188 |
| SA-11 .....                           | Sanitary Transmitter                          | 189 |
| F-20-3A .....                         | F-20 with Sanitary Seal                       | 192 |
| <b>Parts List</b>                     |   |     |
| Miscellaneous Parts List .....        |   | 195 |

For complete detailed information, including electronic pressure, electronic temperature and ultra high purity products, please visit [www.wika.com](http://www.wika.com).

List Prices Effective, January 1, 2013

**DIAPHRAGM SEALS**

**Assembled Seals**

|               |   |     |
|---------------|---|-----|
| M93X.25 ..... | 3/4" Tri-Clamp, 2 1/2" Gauge, 3A Sanitary         | 197 |
| M93X.3A ..... | 1 1/2" Tri-Clamp, 2 1/2" or 4" Gauge, 3A Sanitary | 198 |
| M93X.2C ..... | 3/4" Tri-Clamp, 1 1/2" or 2" Gauge, 3A Sanitary   | 199 |
| M93X.D1 ..... | All-welded System with XSEL® Process Gauge        | 200 |

**Threaded Seals**

|             |                           |     |
|-------------|---------------------------|-----|
| 990.TA..... | Small Diameter Mini Seal  | 201 |
| 990.TB..... | Large Diameter Mini Seal  | 202 |
| 990.10..... | Standard Welded Seal      | 203 |
| 990.TC..... | Clamped Seal              | 204 |
| 990.40..... | Large Diameter Seal       | 205 |
| 990.34..... | All-welded Seal           | 206 |
| 990.36..... | High Pressure Button Seal | 207 |

**Flanged Seals**

|             |   |     |
|-------------|---|-----|
| 990.12..... | Standard Welded Seal Flange (threaded bolt holes) | 208 |
| 990.FA..... | Clamped Seal Flange (threaded bolt holes)         | 209 |
| 990.FC..... | Welded Diaphragm Seal Flange                      | 210 |
| 990.FD..... | Clamped Seal Flange                               | 211 |
| 990.FB..... | All-welded Design Seal Flange                     | 212 |
| 990.26..... | One-piece Seal Flange                             | 213 |
| 990.27..... | Flush Diaphragm Seal Flange                       | 214 |
| 990.FR..... | Rotatable Seal Flange                             | 215 |
| 990.28..... | Pancake-design Seal Flange                        | 216 |
| 990.41..... | Large Diameter Seal Flange                        | 217 |

**Sanitary Seals**

|             |                         |     |
|-------------|-------------------------|-----|
| 990.22..... | Sanitary Tri-Clamp Seal | 218 |
|-------------|-------------------------|-----|

**Plastic Seals**

|             |                     |     |
|-------------|---------------------|-----|
| 990.31..... | Plastic-design Seal | 219 |
|-------------|---------------------|-----|

**InLine Seals**

|             |                            |     |
|-------------|----------------------------|-----|
| 981.10..... | Wafer-design InLine Seal   | 220 |
| 981.22..... | Tri-Clamp InLine Seal      | 221 |
| 981.27..... | Flanged InLine Seal        | 222 |
| 981.31..... | Abrasive-media InLine Seal | 223 |

**Seal Accessories**

|                               |               |     |
|-------------------------------|---------------|-----|
| 910.27.....                   | Flushing Ring | 224 |
| 910.ZA.....                   | Saddle Flange | 225 |
| General Seal Information..... |               | 226 |

**MECHANICAL TEMPERATURE**

**Bimetal Thermometers**

|   |                              |     |
|---|------------------------------|-----|
| TI.1005.....                            | Pocket Test, Back Mount      | 230 |
| TI.ST.....                              | Surface Mount, Magnetic      | 230 |
| TI.20.....                              | 2" Industrial, Back Mount    | 230 |
| TI.T20 / TI.T17.....                    | Thin-stem, Back Mount        | 231 |
| TI.30/TI.50.....                        | Process Grade, Back Mount    | 232 |
| TI.31/TI.51.....                        | Process Grade, Lower Mount   | 232 |
| TI.32/TI.52.....                        | Process Grade, All Angle     | 233 |
| TI.33 / TI.53.....                      | Industrial Grade, Back Mount | 233 |
| Bimetal Thermometer Pricing Matrix..... |                              | 234 |

**Digital Thermometers**

|                    |               |     |
|--------------------|---------------|-----|
| TI.80 / TI.82..... | Solar Digital | 236 |
|--------------------|---------------|-----|

**Twin-Temp Thermometers**

|                                    |                         |     |
|------------------------------------|-------------------------|-----|
| TT.30 / TT.32 / TT.50 / TT.52..... | Back Mount or All Angle | 237 |
| TT.80 / TT.82.....                 | Back Mount or All Angle | 239 |

List Prices Effective, January 1, 2013

|   |                                       |
|---|---------------------------------------|
| <b>Gas Actuated Thermometers</b>        |                                       |
| TI.R45 / TI.R60 .....                   | Gas Actuated 240                      |
| TI.TSG60.....                           | Gas Actuated Temperature Switches 242 |
| <b>Vapor Actuated Thermometers</b>      |                                       |
| TI.V20 / TI.V25 / TI.V35 / TI.V45 ..... | Vapor Actuated 243                    |
| <b>Industrial Glass Thermometers</b>    |                                       |
| TI.61102 / TI.61104 .....               | Straight or Back Mount Stem 245       |
| TI.62102 / TI.62104 .....               | Straight or Back Mount Stem 245       |
| TI.701 / TI.901 .....                   | Swivel Nut Stem 246                   |
| TI.D01 .....                            | Solar Industrial 248                  |
| <b>Thermowells</b>                      |                                       |
| TW.TH / TW.15 .....                     | Threaded Configuration 249            |
| TW.FL / TW.10 .....                     | Flanged Configuration 251             |
| TW.SW / TW.20 .....                     | Socket/Weld Configuration 252         |
| TW.SC / TW.30 .....                     | Sanitary Configuration 253            |
| Industrial Glass .....                  | 254                                   |
| <b>ACCESSORIES</b>                      |                                       |
| 910.10 Gauge Cocks.....                 | 255                                   |
| 910.11 Needle Valves.....               | 255                                   |
| 910.11.100 Mini-Needle Valves.....      | 256                                   |
| 910.11.200 Block & Bleed Valves.....    | 256                                   |
| 910.11.300 Multi-Port Valves .....      | 256                                   |
| 910.12.100 / 910.12.200 /               |                                       |
| 910.12.300 Snubbers.....                | 257                                   |
| 910.13 Overpressure Protectors.....     | 258                                   |
| 910.14.100 Test Port Plugs.....         | 258                                   |
| 910.14.200 Adaptors.....                | 258                                   |
| 910.14.300 Couplings .....              | 258                                   |
| 910.24 Mini-Siphon .....                | 259                                   |
| 910.15.100 / 910.15.200 Siphons .....   | 259                                   |
| CP3000/CP4000 Alarm Contacts .....      | 260                                   |
| 904.XX .....                            | 260                                   |
| Accessories.....                        | 261                                   |
| <b>REFERENCES</b>                       |                                       |
| Available Dial Artwork.....             | 265                                   |
| Standard Dial Layouts .....             | 266                                   |
| Temperature Conversion Chart.....       | 270                                   |
| Press Unit Cross Reference Chart.....   | 271                                   |

# SELECTING A PRESSURE GAUGE

Price List > Selecting a Pressure Gauge

## Selecting a Pressure Gauge

When selecting a pressure gauge, it is important to consider the following factors to ensure safety and accuracy:

1. Pressure fluid composition
2. Pressure fluid temperature
3. Ambient conditions
4. Pressure range
5. Conditions affecting wear of the system
6. Method of mounting
7. Required accuracy

### 1. Pressure fluid composition

Since the sensing element of a pressure gauge may be exposed directly to the measured medium, consider the characteristics of this medium. It may be corrosive, it may solidify at various temperatures or it may contain solids that will leave deposits inside the sensing element. For pressure fluids that will not solidify under normal conditions or leave deposits, a Bourdon tube gauge is acceptable. Otherwise a Sealgauge or diaphragm seal should be used. A chemical compatibility chart follows this section to aid in the selection of the proper sensing element material.

### 2. Pressure fluid temperature

Steam and other hot media may raise the temperature of the gauge components above safe working limits of the sealed joints. In these cases it is recommended that a siphon, cooling tower or diaphragm seal be used in conjunction with the pressure gauge.

### 3. Ambient conditions

The normal ambient temperature range for WIKA pressure gauges is -40°F to +140°F (-40°C to +60°C) for dry or silicone-filled gauges and -4°F to +140°F (-20°C to +60°C) for glycerine-filled gauges. The error caused by temperature changes is +0.3% or -0.3% per 18°F rise or fall, respectively. The reference temperature is 70°F (20°C). The correction is for the temperature of the gauge and not the temperature of the measured medium. Remote gauge mounting using a diaphragm seal and capillary line is one alternative for applications involving extreme ambient temperature.

Moisture and weather effects must also be considered. Liquid-filled gauges prevent condensation build up. For outdoor use, stainless steel, brass or plastic cased gauges are recommended.

### 4. Pressure range

A gauge range of twice the working pressure is generally selected. The working pressure in all cases should be limited to 75% of the gauge range. Where alternating pressure and pulsation are encountered, working pressure should be limited to 2/3 of the gauge range.

### 5. Conditions affecting wear of the system

In applications involving severe pressure fluctuation or pulsation, the use of restrictors and/or snubbers is recommended. In addition, liquid-filled gauges increase the service life of gauges in these conditions. WIKA liquid-filled gauges are generally filled with glycerine. Silicone for larger temperature extremes and Halocarbon® for use with oxidizing agents such as chlorine, oxygen and hydrogen peroxide are also available.

### 6. Method of mounting

Radial (LM) and back (CBM or LBM) connections are available for most WIKA gauges. WIKA stocks gauges with standard NPT threaded connections. Other types such as metric threads, straight threads, hose barbs and special fittings are available as a special order.

Pressure gauges should be mounted in the upright position. For applications where the gauge is mounted side ways, horizontally or upside down, contact WIKA Customer Service for gauge type compatibility.

### 7. Required accuracy

WIKA stocks gauges with accuracies from  $\pm 3/2/3\%$  to  $\pm 0.1\%$  of span (*ASME Grade B to Grade 4A*).

To ensure safe and accurate gauge selection, you must take all of the above factors into consideration. When in doubt, please do not hesitate to contact your local stocking distributor or WIKA Customer Service for assistance!

1-888-WIKA-USA

# CHEMICAL COMPATIBILITY CHART

Price List > Chemical Compatibility Chart

## Chemical Compatibility Chart

|                     |   |                     |   |                        |   |
|---------------------|---|---------------------|---|------------------------|---|
| Acetic Acid         | B | Ethyl Acetate       | A | Oxygen                 | A |
| Acetic Anhydride    | D | Ethyl Cellulose     | B | Paraffin               | A |
| Acetone             | B | Ethylene            | A | Phosphoric Acid        | B |
| Acetylene           | B | Ethylene Dibromide  | B | Photographic Solutions | B |
| Alcohol             | A | Ethylene Dichloride | D | Pickling Solutions     | B |
| Alums               | B | Ethylene Glycol     | A | Picric Acid            | B |
| Aluminum Sulfate    | B | Ferric Nitrate      | B | Picric Acid (dry)      | B |
| Ammonia             | B | Ferric Sulfate      | B | Potassium Chloride     | D |
| Ammonium Carbonate  | B | Formaldehyde        | B | Potassium Cyanide      | B |
| Ammonium Hydroxide  | D | Freon               | A | Potassium Permanganate | B |
| Ammonium Phosphate  | D | Gallic Acid         | B | Prestone               | A |
| Beer                | A | Gas (for lighting)  | A | Salicylic Acid         | A |
| Benzine             | A | Gasoline            | A | Sea Water              | C |
| Benzol              | A | Gasoline (refined)  | B | Silver Nitrate         | B |
| Benzyl Alcohol      | B | Glucose             | C | Sodium Carbonate       | D |
| Bleach Liquors      | B | Glycerine           | A | Sodium Cyanide         | D |
| Bordeaux Mixture    | A | Hydrocyanic Acid    | B | Sodium Hydroxide       | D |
| Butane              | B | Hydrogen            | B | Sodium Nitrate         | B |
| Butanol             | A | Hydrogen Peroxide   | B | Sodium Peroxide        | B |
| Butyric Acid        | B | Kerosene            | A | Sodium Phosphate       | B |
| Calcium Bisulfite   | B | Lacquers            | A | Sodium Sulfate         | B |
| Calcium Chloride    | C | Lactic Acid         | B | Sodium Sulfide         | D |
| Calcium Hydroxide   | B | Lysol               | B | Sodium Sulfite         | B |
| Carbon Dioxide(dry) | B | Magnesium Hydroxide | C | Sulfur Dioxide         | D |
| Carbon Bisulfide    | B | Magnesium Sulfate   | B | Sulfur Dioxide (dry)   | B |
| Casein              | B | Mercury             | B | Sulfuric (75%)         | B |
| Chloroform          | B | Methyl Chloride     | D | Sulfurous Acid         | B |
| Chromic Acid        | B | Methyl Salicylate   | D | Tanning Liquors        | D |
| Citric Acid         | B | Naphtha             | A | Toluene                | A |
| Coal Gas            | A | Nickel Acetate      | B | Vegetable Oils         | B |
| Copper Sulfate      | B | Nitric Acid (pure)  | B | Vinegar                | B |
| Cottonseed Oil      | B | Nitrous Acid        | D | Water                  | A |
| Creosote (crude)    | B | Nitrous Oxide       | D | Whiskey                | B |
| Dextrine            | A | Oil (lubricating)   | A | Wines                  | B |
| Ethers              | D | Oil (refined)       | A | Zinc Sulfate           | B |

**NOTE: For steam service, a siphon is required.**

Find the process fluid in the table above and match the letter Code (A,B,C or D) with the wetted part material listed below:

**A = Brass (Copper alloy)    B = 316 SS    C = Monel®    D = Consult Factory**

This table is provided as a reference only and is accurate to the best of WIKA's knowledge. WIKA assumes no responsibility for, or obligation from, the information here.



# ADVANTAGES OF LIQUID-FILLED GAUGES

Price List > Advantages of Liquid-filled Gauges

## Advantages of Liquid-filled Gauges

### Liquid-filled gauges

Liquid-filled pressure gauges provide a number of advantages:

- the liquid absorbs vibration and pressure spikes
- the dampening action of the liquid enables the operator to take readings during conditions of rapid dynamic loading and vibration
- the liquid lubricates all moving elements, dramatically reducing wear in the movement
- because most liquid-filled gauges are filled with non-aqueous liquid and hermetically sealed, they perform in corrosive environments and are immune to moisture penetration and icing and shock effects are lessened

Liquid-filled gauges enhance the reliability and integrity of the measuring system for long periods under extreme operating conditions.

### Liquid-fill fluid

Ambient Temperature Ratings (Table A)

**Allowable operating range** - Temperature range in which the operation of the gauge is not adversely affected by the filling liquid. At temperatures above the maximum rating, the fluid may break down. At temperatures below the minimum rating, the fluid may solidify (freeze).



**NOTE:** Some parts of the pressure gauge may not be able to withstand temperatures above 140°F. Consult with the factory for technical assistance for these applications.

### Choose the right liquid

The type of liquid used to fill the gauge varies with the application. Although pure glycerine provides the best performance in most applications, each has its own requirements. Guidelines to help ensure that a fluid is properly matched to an application are:

- if icing is a problem, use gauges filled with silicone oil or other comparable liquids. They have low viscosities even at -60°C
- if the system has electric accessories, such as contacts, use insulating oils
- if extreme temperature fluctuations are expected, use silicone oils

The higher the liquid viscosity, the greater its dampening capacity. The reason for this is that dampening changes in proportion to the temperature-dependent viscosity of the filling liquid. The suitable degree of dampening depends on the operating requirements the gauge must meet, such as pointer response time, pressure extremes, vibration and changes in pressure. WIKA can recommend specific liquids to suit problem applications.

| Fill Fluid   | Allowable Operating Range    |
|--|------------------------------|
| <b>Glycerine</b><br>Dow 99.7% USP, Synthetic<br>1118 Centistokes at 68°F | -4°F to 140°F -20°C to 60°C  |
| <b>Silicone</b><br>Dow Corning 200 Fluid<br>1000 Centistokes at 77°F     | -40°F to 140°F -40°C to 60°C |
| <b>Halocarbon®</b><br>Halocarbon® Products<br>6.3 Centistokes at 100°F   | -40°F to 140°F -40°C to 60°C |

Table A - Allowable Ambient Temperature Ratings

### Liquid-filled gauge case venting

For pressure gauges with full scale ranges of 300 psi and below (including vacuum and compound ranges of 30" Hg-0-200 psi and below), case venting (after the gauge is installed) is necessary to preserve the accuracy. Temperature fluctuations during shipment and in the process application cause the liquid filling to expand and contract which in turn increases or decreases case pressure. As a result, accuracy can be decreased and the pointer may not return to zero properly until the gauge is vented to the atmosphere.

To vent a WIKA gauge, move the valve to the open position which will release any pressure or vacuum built up in the case. If the gauge is installed in an upright position, the lever can be left in the open position. The lever allows the use of a gauge in a non-upright orientation.

# WIKA TYPE NUMBERS

Price List > WIKA Type Numbers

## WIKA Type Numbers

The following is a guide to the WIKA model numbering system.

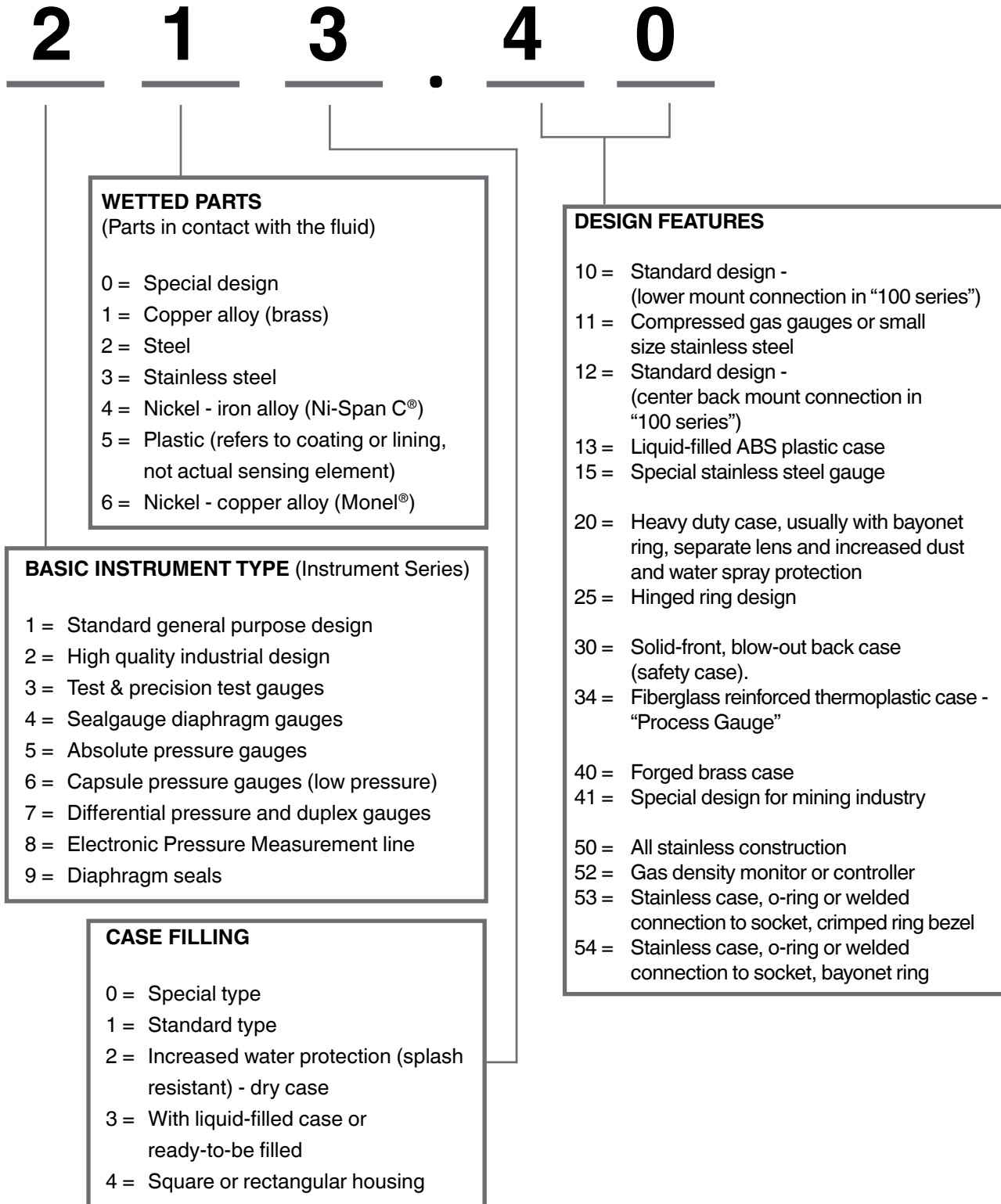

# WIKA TYPE NUMBERS

Price List > WIKA Type Numbers

## Ordering Guidelines for Pressure Gauges

### 1) Quick Order 7- or 8-Digit Part Numbers:

**Example: 9834850**

Use the part number for the instrument you wish to order.

If you need additional options, or don't see a part number referenced for the exact product you need, you may use Descriptive Text as indicated below (see #2). **A 7-or 8-digit part number will be provided with your order confirmation.** The part number provided may then be used for re-ordering purposes.

### 2) Descriptive Text Part Number System:

**Example:**

| Standard Product Description Section |             |                  |                            |           | Additional Options & Accessories   |
|--------------------------------------|-------------|------------------|----------------------------|-----------|------------------------------------|
| <b>232.34</b>                        | <b>4.5</b>  | <b>100 psi</b>   | <b>½"</b>                  | <b>LM</b> | <b>SG, PM</b>                      |
| (Type #)                             | (Dial Size) | (Pressure Range) | (Process Conn. & Location) |           | (Additional Options / Accessories) |

*The above example would indicate a ½" process gauge, dry, 100 psi dial scale, ½" NPT connection, lower mount connection with the following selected options: safety glass (SG) and panel mount (PM), as indicated.*

- Descriptive text can be used anytime you do not find an exact item with a listed part number. You may add as many codes at the end of the descriptive text as is required to configure the product.
- Codes and installed prices are found on a selection chart for each product type. Additional options may be located on the Accessory pages section in the back of the Product Catalog.
- Please reference the WIKA Type Number (pg. 8) for additional product type information. WIKA product types may already determine many configurations for wetted parts and case fill.
- Options and accessories should always appear at the end of the descriptive text, separated by commas. If you are not sure what to use for abbreviated Code, then simply spell it out.

**NOTE: If you provide a part number and descriptive text, we will use the part number only.**

If you are unclear, do not see the Option(s) needed, or require ordering assistance, please contact a WIKA Customer Care or Technical Quote Team representative.

# GENERAL PURPOSE

Mechanical Pressure > General Purpose Gauges > 111.10

## General Purpose Gauges - Black Plastic Case

### Standard features

- **Case:** Black plastic
- **Wetted parts:** Copper alloy
- **Window:** Snap-in acrylic
- **Window ring:** None
- **Dial:** White plastic
- **Pointer:** Black plastic
- **Case fill:** Not available
- **Accuracy:**  $\pm 3/2/3\%$  of span
- **Datasheet:** 111.10



| Type                     | 111.10         |                |                |                |                |                |                |                |
|--------------------------|----------------|----------------|----------------|----------------|----------------|----------------|----------------|----------------|
| Size                     | 1½"            |                | 2"             |                | 2½"            |                | 4"             |                |
| Connection               | LM             |                |                |                |                |                |                |                |
| Conn. size               | ½" NPT         | ½" NPT         | ¼" NPT         |                | ¼" NPT         |                | ¼" NPT         |                |
| Press scale <sup>1</sup> | PSI            | PSI            | PSI            | PSI/KPA        | PSI            | PSI/KPA        | PSI            | PSI/KPA        |
| <b>List price</b>        | <b>\$19.65</b> | <b>\$18.25</b> | <b>\$18.25</b> | <b>\$18.25</b> | <b>\$20.25</b> | <b>\$20.25</b> | <b>\$25.35</b> | <b>\$25.35</b> |
| 30" Hg                   | <b>9747214</b> | <b>8990039</b> | <b>4252901</b> | <b>8990250</b> | <b>4253027</b> | <b>8990471</b> | 4255900        | <b>9767991</b> |
| 30"-0-15 psi             | 52234681       |                | 50786563       |                | <b>4253035</b> | 8990489        | 4255918        | 9768009        |
| 30"-0-30 psi             |                |                | 50786571       |                | <b>4253043</b> | <b>8990497</b> | <b>4255926</b> | 9768017        |
| 30"-0-60 psi             |                |                |                |                | <b>4253051</b> | 8990501        | 4255934        | 9768025        |
| 30"-0-100 psi            | 50169025       |                | 50302418       |                | 4253060        | 8990519        | 4255942        | 9768033        |
| 30"-0-160 psi            |                |                |                |                | 4253078        | 8990527        | 4255951        | 9768041        |
| 30"-0-200 psi            |                |                | 50657569       |                | 4253086        | 8990535        | 4255969        | 9768050        |
| <b>List price</b>        | <b>\$15.95</b> | <b>\$14.80</b> | <b>\$14.80</b> | <b>\$14.80</b> | <b>\$16.45</b> | <b>\$16.45</b> | <b>\$23.40</b> | <b>\$23.40</b> |
| 15 psi                   | <b>9747222</b> | 8990102        | <b>4252919</b> | <b>8990323</b> | <b>4253108</b> | <b>8990552</b> | 4255977        | 9768068        |
| 30 psi                   | <b>9747230</b> | <b>8990110</b> | <b>4252927</b> | <b>8990331</b> | <b>4253116</b> | <b>8990560</b> | <b>4255985</b> | 9768076        |
| 60 psi                   | <b>9747249</b> | 8990128        | <b>4252935</b> | <b>8990349</b> | <b>4253124</b> | <b>8990578</b> | <b>4255993</b> | 9768084        |
| 100 psi                  | <b>9747257</b> | <b>8990136</b> | <b>4252943</b> | <b>8990357</b> | <b>4253132</b> | <b>8990586</b> | <b>4256000</b> | <b>9768092</b> |
| 160 psi                  | <b>9747265</b> | <b>8990145</b> | <b>4252951</b> | <b>8990365</b> | <b>4253141</b> | <b>8990595</b> | 4256018        | <b>9768106</b> |
| 200 psi                  | <b>9747273</b> | 8990153        | <b>4252960</b> | <b>8990374</b> | <b>4253159</b> | <b>8990608</b> | <b>4256026</b> | <b>9768114</b> |
| 300 psi                  | 4233372        | 8990161        | 4252978        | <b>8990382</b> | <b>4253167</b> | <b>8990616</b> | <b>4256034</b> | <b>9768122</b> |
| 400 psi                  | 4233398        |                | 4252986        |                | <b>4253175</b> | <b>8990625</b> | 4256042        | 9768130        |
| 600 psi                  |                |                | 4252994        |                | <b>4253183</b> | <b>8990633</b> | 4256051        | 9768149        |
| <b>List price</b>        | <b>\$20.75</b> | <b>\$19.25</b> | <b>\$19.25</b> | <b>\$19.25</b> | <b>\$21.40</b> | <b>\$21.40</b> | <b>\$25.15</b> | <b>\$25.15</b> |
| 800 psi                  | 50646605       |                |                |                | 4253191        | 8990641        | 4256060        |                |
| 1,000 psi                |                |                | 4253001        | 50402218       | <b>4253205</b> | 8990659        | 4256078        | 9768416        |
| 1,500 psi                |                | 50833383       | 50786598       |                | 4253213        | 8990667        | 4256086        |                |
| 2,000 psi                | 50989309       | 50396609       | 50786601       |                | 4253221        | 8990675        | 4256094        |                |
| 3,000 psi                |                | 50288784       | <b>4253019</b> |                | 4253230        | <b>8990684</b> | 4256107        |                |
| <b>List price</b>        | <b>\$22.70</b> | <b>\$21.00</b> | <b>\$21.00</b> | <b>\$21.00</b> | <b>\$23.40</b> | <b>\$23.40</b> | <b>\$28.10</b> | <b>\$28.10</b> |
| 5,000 psi                | 52164888       | 50288792       |                |                | 4253248        | <b>8990692</b> | 4256115        |                |

<sup>1</sup>Vacuum scale: 30" Hg outside in black; 760 mm Hg inside in red.

Factory stocked items shown in **bold print**.  
Items without part numbers are available - consult factory.

Reference pages 13 and 14 for 111.10 options.

# GENERAL PURPOSE

Mechanical Pressure > General Purpose Gauges > 111.10

## General Purpose Gauges - Black Steel Case

### Standard features

- **Case:** Black steel
- **Wetted parts:** Copper alloy
- **Window:** Snap-in acrylic
- **Window ring:** None
- **Dial:** White plastic
- **Pointer:** Black plastic
- **Case fill:** Not available
- **Accuracy:**  $\pm 3/2/3\%$  of span
- **Datasheet:** 111.10



| Type                           | 111.10   |                |                |
|--------------------------------|--|----------------|----------------|
| Size                           | 1½"  | 2"             | 2½"            |
| <b>Connection</b>              | LM  |                |                |
| <b>Conn. size</b>              | ½" NPT   | ¼" NPT         | ¼" NPT         |
| <b>Press scale<sup>1</sup></b> | PSI  | PSI            | PSI            |
| <b>List price</b>              | <b>\$23.70</b>   | <b>\$22.00</b> | <b>\$24.15</b> |
| 30" Hg                         | 50331841   | 4302192        | 4302397        |
| 30"-0-15 psi                   |  |                |                |
| 30"-0-30 psi                   |  |                |                |
| 30"-0-60 psi                   |  |                |                |
| 30"-0-100 psi                  |  |                |                |
| 30"-0-160 psi                  |  |                |                |
| 30"-0-200 psi                  |  |                |                |
| <b>List price</b>              | <b>\$20.00</b>   | <b>\$18.55</b> | <b>\$20.35</b> |
| 15 psi                         | 50630695   | 4302206        | 4302401        |
| 30 psi                         | 50331787   | 4302214        | <b>4302443</b> |
| 60 psi                         | 50331761   | <b>4302222</b> | <b>8991138</b> |
| 100 psi                        | 50331884   | <b>4302231</b> | <b>8991146</b> |
| 160 psi                        | 50331698   | <b>4302249</b> | 4302419        |
| 200 psi                        | 50369377   | 4302257        | <b>8991162</b> |
| 300 psi                        |  | 4302265        | 4302427        |
| 400 psi                        |  | 4302273        | 4302435        |
| 600 psi                        |  | 4302281        | 8991189        |
| <b>List price</b>              | <b>\$24.80</b>   | <b>\$23.00</b> | <b>\$25.30</b> |
| 800 psi                        |  |                |                |
| 1,000 psi                      |  |                |                |
| 1,500 psi                      |  |                |                |
| 2,000 psi                      |  |                |                |
| 3,000 psi                      |  |                |                |
| <b>List price</b>              | <b>\$26.75</b>   | <b>\$24.75</b> | <b>\$27.30</b> |
| 5,000 psi                      |  |                | 8736499        |

<sup>1</sup>Vacuum scale: 30" Hg outside in black; 760 mm Hg inside in red.

Factory stocked items shown in **bold print**

Items without part numbers are available - consult factory.

Reference pages 13 and 14 for 111.10 options.

# GENERAL PURPOSE

Mechanical Pressure > General Purpose Gauges > 111.10

## General Purpose Gauges - Polished Brass Case

### Standard features

- **Case:** Polished brass
- **Wetted parts:** Copper alloy
- **Window:** Snap-in acrylic
- **Window ring:** Polished brass friction ring
- **Dial:** White plastic
- **Pointer:** Black plastic
- **Case fill:** Not available
- **Accuracy:**  $\pm 3/2/3\%$  of span
- **Datasheet:** 111.10

| Type                     | 111.10   |
|--------------------------|--|
| Size                     | 2½"  |
| Connection               | LM  |
| Conn. size               | ¼" NPT   |
| Press scale <sup>1</sup> | PSI/KPA  |
| List price               | <b>\$40.30</b>   |
| 30" Hg                   | 8735980  |
| 30"-0-15 psi             | 8735999  |
| 30"-0-30 psi             | 8736006  |
| 30"-0-60 psi             | 8736049  |
| 30"-0-100 psi            | 8736014  |
| 30"-0-160 psi            | 8736022  |
| 30"-0-200 psi            | 8736030  |
| 30"-0-300 psi            |  |
| 30"-0-400 psi            |  |
| List price               | <b>\$36.45</b>   |
| 15 psi                   | <b>8736219</b>   |
| 30 psi                   | <b>8736227</b>   |
| 60 psi                   | <b>8736235</b>   |
| 100 psi                  | <b>8736243</b>   |
| 160 psi                  | <b>8736251</b>   |
| 200 psi                  | 8736260  |
| 300 psi                  | <b>8736278</b>   |
| 400 psi                  | 8736286  |
| 600 psi                  | <b>8736294</b>   |
| List price               | <b>\$41.45</b>   |
| 800 psi                  | 8736308  |
| 1,000 psi                | 8738548  |
| 1,500 psi                | 8736464  |
| 2,000 psi                | 8736472  |
| 3,000 psi                | 8736480  |
| List price               | <b>\$43.40</b>   |
| 5,000 psi                | 8736499  |



Additional scales available; contact factory for more information.

Factory stocked items shown in **bold print**  
Items without part numbers are available - consult factory.

Reference pages 13 and 14 for 111.10 options.

# GENERAL PURPOSE

Mechanical Pressure > General Purpose Gauges > Options for 111.10

## Options for type 111.10

| Option  | Code           | 111.10<br>1½" LM | 111.10<br>2" LM | 111.10<br>2½" LM | 111.10<br>4" LM |
|---|----------------|------------------|-----------------|------------------|-----------------|
| <b>Case / ring options</b>                          |                |                  |                 |                  |                 |
| Chrome-plated plastic                               | PL CHR         | \$1.95           | \$2.35          | n/a              | n/a             |
| Black polycarbonate                                 | PC             | n/a              | n/a             | n/a              | \$1.00          |
| Black-painted steel                                 | ST BLK         | \$4.05           | \$3.75          | \$3.90           | \$4.70          |
| Gold-painted steel                                  | ST GOLD        | n/a              | \$3.75          | \$3.90           | n/a             |
| Chrome-plated steel                                 | ST CHR         | \$5.65           | \$5.65          | \$6.20           | n/a             |
| Stainless steel                                     | SS             | \$11.70          | \$11.70         | \$11.70          | n/a             |
| Friction ring, black-painted steel (add metal case) | FR ST          | \$2.25           | \$4.15          | \$3.30           | \$14.60         |
| Friction ring, stainless steel (add metal case)     | FR SS          | \$4.20           | \$4.50          | \$7.00           | n/a             |
| <b>Connections</b>                                  |                |                  |                 |                  |                 |
| 1/8" NPT or 1/4" NPT                                | 1/8" or 1/4"   | \$0.00           | \$0.00          | \$0.00           | \$0.00          |
| G1/8B or G1/4B                                      | G1/8B or G1/4B | \$0.00           | \$0.00          | \$0.00           | \$0.00          |
| R1/8 or R1/4-ISO7                                   | R1/8 or R1/4   | \$2.60           | \$2.60          | \$2.60           | \$2.60          |
| 7/16-20 SAE   | SAE            | n/a              | \$8.10          | \$8.10           | \$8.10          |
| 1/2" NPT  | 1/2            | n/a              | n/a             | n/a              | \$2.60          |
| 3, 9 or 12 O'clock position                         | (3,9,12)CLK    | \$9.05           | \$9.05          | \$9.05           | \$9.05          |
| Nickel-plated connection                            | NKL SKT        | \$4.25           | \$4.25          | \$4.25           | \$7.05          |
| 10-32 internal tap                                  | 10-32          | \$1.85           | \$1.85          | \$1.85           | \$1.85          |
| Teflon® tape on connection                          | TT             | \$0.70           | \$0.70          | \$0.70           | \$0.70          |
| <b>Mounting</b>                                     |                |                  |                 |                  |                 |
| Front flange, steel black (includes steel case)     | FF             | n/a              | \$18.30         | \$17.00          | n/a             |
| Rear flange, steel black                            | RF             | n/a              | n/a             | n/a              | \$19.30         |
| <b>Windows</b>                                      |                |                  |                 |                  |                 |
| Polycarbonate, snap-in                              | PC             | \$0.70           | \$0.70          | \$0.70           | \$0.85          |
| Flat glass (add metal case & ring)                  | GLS            | \$1.25           | \$1.25          | \$1.25           | \$2.35          |
| Safety glass (add metal case & ring)                | SG             | n/a              | n/a             | \$4.45           | n/a             |
| <b>Pointers</b>                                     |                |                  |                 |                  |                 |
| Drag pointer, red (add metal case & ring)           | DP             | n/a              | n/a             | \$23.10          | n/a             |
| Mark pointer, red (add metal case & ring)           | MP             | n/a              | n/a             | \$7.40           | \$16.40         |
| <b>Restrictors</b>                                  |                |                  |                 |                  |                 |
| Brass, press-fit, 0.3mm orifice                     | R              | \$2.00           | \$2.00          | \$2.00           | \$2.00          |
| Brass, M5 thread, 0.5mm orifice                     | R0.5           | \$2.75           | \$2.75          | \$2.75           | \$2.75          |
| Sintered metal filter, brass                        | FLT            | \$3.90           | \$3.90          | \$3.90           | \$3.90          |
| Sintered metal filter, SS                           | FLT SS         | \$4.70           | \$4.70          | \$4.70           | \$4.70          |
| <b>Dials &amp; scales</b>                           |                |                  |                 |                  |                 |
| Dial, aluminum white                                | DIAL AL        | \$0.25           | \$0.25          | \$0.25           | n/a             |
| Dial, luminescent                                   | LUM            | \$4.45           | n/a             | \$4.45           | \$9.75          |
| Receiver scales (3-15 PSI)                          | REC            | \$2.40           | \$2.40          | \$2.40           | \$2.40          |
| <b>Movements</b>                                    |                |                  |                 |                  |                 |
| Silicone-dampened movement                          | DAMP           | \$2.45           | \$2.45          | \$2.45           | \$2.45          |
| <b>Special accuracy / calibration</b>               |                |                  |                 |                  |                 |
| ±2/1/2% of span                                     | 2/1/2%         | \$1.75           | \$1.75          | \$1.75           | \$1.75          |

Shaded options are non-standard and may require extended lead-times

For datasheets and additional information, please visit [www.wika.com](http://www.wika.com) or call 1-888-945-2872.

# GENERAL PURPOSE

Mechanical Pressure > General Purpose Gauges > Options for 111.10

## Options for type 111.10

| Option  | Code | 111.10<br>1½" LM               | 111.10<br>2" LM | 111.10<br>2½" LM | 111.10<br>4" LM |
|---|------|--------------------------------|-----------------|------------------|-----------------|
| <b>Other</b>                                    |      |                                |                 |                  |                 |
| Clean for O2 service (ASME Level IV)            | O2   | \$19.45                        | \$19.45         | \$19.45          | \$19.45         |
| Serial number on dial                           | SER# | \$3.40                         | \$3.40          | \$3.40           | \$3.40          |
| Tire valve on connection                        | TIRE | n/a                            | \$6.95          | \$6.95           | n/a             |
| Blue rubber cover                               | BCOV | n/a                            | \$16.60         | \$16.60          | \$22.75         |
| Red rubber cover                                | RCOV | n/a                            | n/a             | \$16.60          | n/a             |
| Black rubber cover                              | KCOV | n/a                            | \$16.60         | \$16.60          | n/a             |
| <b>Other options available</b>                  |      |                                |                 |                  |                 |
| Calibration and material certificates           |      | <i>Refer to pages 261, 262</i> |                 |                  |                 |
| Special scales, logos and other artwork charges |      | <i>Refer to pages 263, 265</i> |                 |                  |                 |
| Needle valves, siphons and other accessories    |      | <i>Refer to pages 255-259</i>  |                 |                  |                 |

Shaded options are non-standard and may require extended lead-times



# GENERAL PURPOSE

Mechanical Pressure > General Purpose Gauges > 111.12

## General Purpose Gauges - Black Plastic Case

### Standard features

- **Case:** Black plastic
- **Wetted parts:** Copper alloy
- **Window:** Snap-in acrylic
- **Window ring:** None
- **Dial:** White plastic
- **Pointer:** Black plastic
- **Case fill:** Not available
- **Accuracy:**  $\pm 3/2/3\%$  of span
- **Datasheet:** 111.12



| Type                     | 111.12  |                        |                |                |                |                        |                |                |
|--------------------------|---|------------------------|----------------|----------------|----------------|------------------------|----------------|----------------|
| Size                     | 1½"   |                        | 2"             |                |                |                        | 2½"            |                |
| Connection               | CBM  |                        |                |                |                |                        |                |                |
| Conn. size               | ½" NPT  |                        | ½" NPT         | ¼" NPT         |                |                        | ¼" NPT         |                |
| Press scale <sup>1</sup> | PSI   | PSI/KG/CM <sup>2</sup> | PSI            | PSI            | PSI/KPA        | PSI/KG/CM <sup>2</sup> | PSI            | PSI/KPA        |
| <b>List price</b>        | <b>\$20.95</b>  | <b>\$20.95</b>         | <b>\$19.45</b> | <b>\$19.45</b> | <b>\$19.45</b> | <b>\$19.45</b>         | <b>\$21.60</b> | <b>\$21.60</b> |
| 30" Hg                   | <b>9690128</b>  | <b>9692635</b>         | <b>9690357</b> | 4253256        | <b>9690586</b> | 9692784                | 4253371        | 9691035        |
| 30"-0-15 psi             |   |                        |                |                |                |                        | 4253389        | 9691044        |
| 30"-0-30 psi             |   |                        | 50741713       | 50982746       |                |                        | 4253397        | 9691052        |
| 30"-0-60 psi             |   |                        |                | 4300017        |                |                        | 4253400        | 9691060        |
| 30"-0-100 psi            |   |                        |                |                |                |                        | 4253418        | 9691078        |
| 30"-0-160 psi            |   |                        |                | 50404768       |                |                        | 4253426        | 9691086        |
| 30"-0-200 psi            |   |                        |                |                |                |                        | 4253434        | 9691095        |
| 30"-0-300 psi            |   |                        |                |                |                |                        |                |                |
| 30"-0-400 psi            |   |                        |                |                |                |                        |                |                |
| <b>List price</b>        | <b>\$17.25</b>  | <b>\$17.25</b>         | <b>\$16.00</b> | <b>\$16.00</b> | <b>\$16.00</b> | <b>\$16.00</b>         | <b>\$17.80</b> | <b>\$17.80</b> |
| 15 psi                   | <b>9690209</b>  | 9692644                | <b>9690438</b> | 4253264        | <b>9690667</b> | 9692792                | 4253451        | <b>9691116</b> |
| 30 psi                   | <b>9690217</b>  | <b>9691923</b>         | <b>9690446</b> | <b>4253272</b> | <b>9690675</b> | 9692805                | <b>4253460</b> | <b>9691125</b> |
| 60 psi                   | <b>9690225</b>  | <b>9692652</b>         | <b>9690455</b> | <b>4253281</b> | <b>9690684</b> | 9692814                | <b>4253478</b> | <b>9691133</b> |
| 100 psi                  | <b>9690234</b>  | <b>9692660</b>         | <b>9690463</b> | <b>4253290</b> | <b>9690692</b> | 9692822                | <b>4253486</b> | <b>9691141</b> |
| 160 psi                  | <b>9690242</b>  | <b>9692678</b>         | <b>9690471</b> | <b>4253302</b> | <b>9690705</b> | <b>9692830</b>         | <b>4253494</b> | <b>9691159</b> |
| 200 psi                  | <b>9690250</b>  | 9692686                | 9690489        | <b>4253311</b> | <b>9690714</b> | 9692848                | 4253507        | <b>9691167</b> |
| 300 psi                  | 4233355   |                        | 9690497        | 4253329        | <b>9690722</b> | 9692856                | 4253515        | 9691175        |
| 400 psi                  | 4354385   |                        | 4386082        | 4253337        |                | 50676474               | 4253523        | 9691184        |
| 600 psi                  | 9690285   |                        | 4228930        | 4253345        |                | 9692873                | 4253531        | 9691192        |
| <b>List price</b>        | <b>\$22.05</b>  | <b>\$22.05</b>         | <b>\$20.45</b> | <b>\$20.45</b> | <b>\$20.45</b> | <b>\$20.45</b>         | <b>\$22.75</b> | <b>\$22.75</b> |
| 800 psi                  |   |                        |                |                |                |                        | 4253541        | 9691205        |
| 1,000 psi                | 9765654   |                        | 4256585        | 4253353        |                | 9692881                | 4253559        | 9691214        |
| 1,500 psi                | 8985823   |                        |                | 52255034       |                |                        | 4253567        | 9691222        |
| 2,000 psi                |   |                        |                | 52207374       |                |                        | 4253575        | 9691230        |
| 3,000 psi                |   |                        | 50075322       | 4253361        |                | 9692899                | 4253583        | 9691248        |
| <b>List price</b>        | <b>\$24.00</b>  | <b>\$24.00</b>         | <b>\$22.20</b> | <b>\$22.20</b> | <b>\$22.20</b> | <b>\$22.20</b>         | <b>\$24.75</b> | <b>\$24.75</b> |
| 5,000 psi                | 8986154   |                        |                |                |                |                        | 4253591        | 9691256        |

<sup>1</sup> "PSI/KG/CM<sup>2</sup>" denotes dual scale; PSI outside in black, KG/CM<sup>2</sup> inside in red. Note: Vacuum scale: 30" Hg outside in black; 760 mm Hg inside in red.

Factory stocked items shown in **bold print**

Items without part numbers are available - consult factory.

Reference pages 17 and 18 for 111.12 options.

# GENERAL PURPOSE

Mechanical Pressure > General Purpose Gauges > 111.12

## General Purpose Gauges - Black Steel Case

### Standard features

- **Case:** Black steel
- **Wetted parts:** Copper alloy
- **Window:** Snap-in acrylic
- **Window ring:** None
- **Dial:** White plastic
- **Pointer:** Black plastic
- **Case fill:** Not available
- **Accuracy:**  $\pm 3/2/3\%$  of span
- **Datasheet:** 111.12



| Type                     | 111.12  |                |  |
|--------------------------|---|----------------|--|
| Size                     | 1½"   | 2"             | 2½"  |
| Connection               | CBM  |                | CBM/UC  |
| Conn. size               | ½" NPT  | ¼" NPT         | ¼" NPT   |
| Press scale <sup>1</sup> | PSI   | PSI            | PSI/KPA  |
| <b>List price</b>        | <b>\$25.00</b>  | <b>\$23.20</b> | <b>\$37.55</b>   |
| 30" Hg                   | 4301838   | 4302001        | <b>9311887</b>   |
| 30"-0-15 psi             |   |                |  |
| 30"-0-30 psi             |   |                |  |
| 30"-0-60 psi             |   |                |  |
| 30"-0-100 psi            |   |                |  |
| 30"-0-160 psi            |   |                |  |
| 30"-0-200 psi            |   |                |  |
| 30"-0-300 psi            |   |                |  |
| 30"-0-400 psi            |   |                |  |
| <b>List price</b>        | <b>\$21.30</b>  | <b>\$19.75</b> | <b>\$33.75</b>   |
| 15 psi                   | 4301846   | 4302010        |  |
| 30 psi                   | <b>4234090</b>  | <b>4302028</b> | 9311895  |
| 60 psi                   | <b>4301854</b>  | 4302036        | <b>9311909</b>   |
| 100 psi                  | <b>4301862</b>  | <b>4302044</b> | <b>9311925</b>   |
| 160 psi                  | <b>4233395</b>  | <b>4302052</b> | <b>9311934</b>   |
| 200 psi                  | 4301871   | 4302061        | <b>9311942</b>   |
| 300 psi                  |   | 4302079        | 9311917  |
| 400 psi                  |   | 4302087        |  |
| 600 psi                  |   | 4302095        | 9311950  |
| <b>List price</b>        | <b>\$26.10</b>  | <b>\$24.20</b> | <b>\$38.70</b>   |
| 800 psi                  |   |                |  |
| 1,000 psi                |   |                |  |
| 1,500 psi                |   |                |  |
| 2,000 psi                |   |                |  |
| 3,000 psi                |   |                |  |
| <b>List price</b>        | <b>\$28.05</b>  | <b>\$25.95</b> | <b>\$40.70</b>   |
| 5,000 psi                |   |                |  |

<sup>1</sup> Vacuum scale: 30" Hg outside in black; 760 mm Hg inside in red.

Factory stocked items shown in **bold print**. Items without part numbers are available - consult factory.

Reference pages 17 and 18 for 111.12 options.

# GENERAL PURPOSE

Mechanical Pressure > General Purpose Gauges > Options for 111.12

## Options for type 111.12

| Option  | Code           | 111.12<br>1½" CBM | 111.12<br>2" CBM | 111.12<br>2½" CBM | 111.12<br>4" CBM |
|---|----------------|-------------------|------------------|-------------------|------------------|
| <b>Case / ring options</b>                          |                |                   |                  |                   |                  |
| Chrome-plated plastic                               | PL CHR         | \$1.95            | n/a              | n/a               | n/a              |
| Black-painted steel                                 | ST BLK         | \$4.05            | \$3.75           | \$3.90            | n/a              |
| Stainless steel                                     | SS             | \$11.70           | \$11.70          | \$11.70           | n/a              |
| Chrome-plated steel                                 | ST CHR         | \$2.45            | \$2.75           | n/a               | n/a              |
| Friction ring, black-painted steel (add metal case) | FR ST          | \$2.25            | \$4.15           | \$3.30            | \$14.60          |
| Friction ring, chrome-plated steel (add metal case) | FR CHR         | \$3.40            | \$3.65           | \$3.90            | n/a              |
| <b>Connections</b>                                  |                |                   |                  |                   |                  |
| 1/8" NPT or 1/4" NPT                                | 1/8" or 1/4"   | \$0.00            | \$0.00           | \$0.00            | \$0.00           |
| G1/8B or G1/4B                                      | G1/8B or G1/4B | \$0.00            | \$0.00           | \$0.00            | \$0.00           |
| R1/8 or R1/4-ISO7                                   | R1/8 or R1/4   | \$2.60            | \$2.60           | \$2.60            | \$2.60           |
| 7/16-20 SAE   | SAE            | n/a               | \$8.10           | \$8.10            | \$8.10           |
| Nickel-plated connection                            | NKL SKT        | \$4.25            | \$4.25           | \$4.25            | \$7.05           |
| 10-32 internal tap                                  | 10-32          | \$1.85            | \$1.85           | \$1.85            | \$1.85           |
| Teflon® tape on connection                          | TT             | \$0.70            | \$0.70           | \$0.70            | \$0.70           |
| <b>Mounting</b>                                     |                |                   |                  |                   |                  |
| Front flange, steel black (includes steel case)     | FF             | n/a               | n/a              | \$20.40           | n/a              |
| Front flange, steel chrome (includes steel case)    | FF CHR         | n/a               | n/a              | \$23.65           | n/a              |
| U-clamp, pol ss ring, black steel case              | UC SS          | \$15.95           | \$15.95          | n/a               | n/a              |
| U-clamp, black ring, black steel case               | UC ST          | \$15.95           | n/a              | n/a               | n/a              |
| UC, chrome ring, black steel case                   | UC             | n/a               | n/a              | \$15.95           | n/a              |
| <b>Windows</b>                                      |                |                   |                  |                   |                  |
| Polycarbonate, snap-in                              | PC             | \$0.70            | \$0.70           | \$0.70            | \$0.70           |
| Flat glass (add metal case & ring)                  | GLS            | \$1.25            | \$1.25           | \$1.25            | \$2.35           |
| Safety glass (add metal case & ring)                | SG             | n/a               | n/a              | \$4.45            | n/a              |
| <b>Pointers</b>                                     |                |                   |                  |                   |                  |
| Drag pointer, red (add metal case & ring)           | DP             | n/a               | n/a              | \$23.10           | n/a              |
| Mark pointer, red (add metal case & ring)           | MP             | n/a               | n/a              | \$7.40            | n/a              |
| <b>Restrictors</b>                                  |                |                   |                  |                   |                  |
| Brass, press-fit, 0.3mm orifice                     | R              | \$2.00            | \$2.00           | \$2.00            | \$2.00           |
| Brass, M5 thread, 0.5mm orifice                     | R0.5           | \$2.75            | \$2.75           | \$2.75            | \$2.75           |
| Sintered metal filter, brass                        | FLT            | \$3.90            | \$3.90           | \$3.90            | \$3.90           |
| Sintered metal filter, SS                           | FLT SS         | \$4.70            | \$4.70           | \$4.70            | \$4.70           |
| <b>Dials &amp; scales</b>                           |                |                   |                  |                   |                  |
| Dial, aluminum white                                | DIAL AL        | \$0.25            | \$0.25           | \$0.25            | n/a              |
| Dial, luminescent                                   | LUM            | \$4.45            | n/a              | \$4.45            | \$9.75           |
| Receiver scales (3-15 PSI)                          | REC            | \$2.40            | \$2.40           | \$2.40            | \$2.40           |
| <b>Movements</b>                                    |                |                   |                  |                   |                  |
| Silicone dampened movement                          | DAMP           | \$2.45            | \$2.45           | \$2.45            | \$2.45           |
| <b>Special accuracy / calibration</b>               |                |                   |                  |                   |                  |
| ±2/1/2% of span                                     | 2/1/2%         | \$1.75            | \$1.75           | \$1.75            | \$1.75           |

Shaded options are non-standard and may require extended lead-times

For datasheets and additional information, please visit [www.wika.com](http://www.wika.com) or call 1-888-945-2872.

# GENERAL PURPOSE

Mechanical Pressure > General Purpose Gauges > Options for 111.12

## Options for type 111.12

| Option  | Code | 111.12<br>1½" CBM       | 111.12<br>2" CBM | 111.12<br>2½" CBM | 111.12<br>4" CBM |
|---|------|-------------------------|------------------|-------------------|------------------|
| <b>Other</b>                                    |      |                         |                  |                   |                  |
| Clean for O2 service (ASME Level IV)            | O2   | \$19.45                 | \$19.45          | \$19.45           | \$19.45          |
| Serial number on dial                           | SER# | \$3.40                  | \$3.40           | \$3.40            | \$3.40           |
| Blue rubber cover                               | BCOV | n/a                     | \$16.60          | \$16.60           | \$22.75          |
| Red rubber cover                                | RCOV | n/a                     | n/a              | \$16.60           | n/a              |
| Black rubber cover                              | KCOV | n/a                     | \$16.60          | \$16.60           | n/a              |
| Clear plastic adaptor ring                      | CRNG | n/a                     | \$4.95           | \$3.45            | n/a              |
| Black plastic adaptor ring                      | BRNG | n/a                     | \$3.45           | \$3.45            | n/a              |
| <b>Other options available</b>                  |      |                         |                  |                   |                  |
| Calibration and material certificates           |      | Refer to pages 261, 262 |                  |                   |                  |
| Special scales, logos and other artwork charges |      | Refer to pages 263, 265 |                  |                   |                  |
| Needle valves, siphons and other accessories    |      | Refer to pages 255-259  |                  |                   |                  |

Shaded options are non-standard and may require extended lead-times

# GENERAL PURPOSE

Mechanical Pressure > General Purpose Gauges > 111.11RF

## General Purpose Gauges - Refrigeration Gauges

### Standard features

- **Case:** Red or blue ABS
- **Wetted parts:** Copper alloy
- **Window:** Twist-lock polycarbonate
- **Window ring:** None
- **Dial:** White aluminum
- **Pointer:** Black aluminum
- **Case fill:** Not available
- **Accuracy:**  $\pm 1/2/5\%$  of span
- **Zero adjustment screw on dial**
- **Flutterless movement**
- **Datasheet:** 111.11RF



| Type   | 111.11RF                |                |
|--|-------------------------|----------------|
| Size   | 2 1/2"                  |                |
| Connection                                     | LM ●                    |                |
| Conn. size                                     | 1/8" NPT                |                |
| Press scale <sup>1</sup>                       | PSI & R12,<br>R22, R502 | PSI & R134a    |
| List price                                     | <b>\$22.35</b>          | <b>\$22.35</b> |
| 30" Hg/0/120 psi rtd. 350 psi<br>Blue ABS case | 4239165                 | 4258526        |
| 500 psi<br>Red ABS case                        | 4239173                 | 4258534        |

Factory stocked items shown in **bold print**  
Items without part numbers are available - consult factory.

# GENERAL PURPOSE

Mechanical Pressure > General Purpose Gauges > 111.10SP

## General Purpose Gauges - Fire Sprinkler Gauges

### Standard features

- **Case:** Black polycarbonate
- **Wetted parts:** Copper alloy
- **Window:** Snap-in acrylic
- **Window ring:** None
- **Dial:** White plastic
- **Pointer:** Black aluminum
- **Case fill:** Not available
- **Accuracy:**  $\pm 3/2/3\%$  of span
- **Datasheet:** 111.10SP



| Type                          | 111.10SP   |
|-------------------------------|--|
| Size                          | 4"   |
| Connection                    | LM  |
| Conn. size                    | 1/4" NPT   |
| Press scale                   | PSI  |
| List price                    | \$22.35  |
| 300 psi "WATER"               | 4233761  |
| List price                    | \$25.10  |
| 80 psi rated to 250 psi "AIR" | 4233779  |
| Accessories (installed)       |  |
| Restrictor, brass             | \$2.00<br>R  |

# GENERAL PURPOSE

Mechanical Pressure > General Purpose Gauges > 111.11

## General Purpose Gauges - Compressed Gas Gauges

### Standard features

- **Case:** Gold-painted steel or polished brass
- **Wetted parts:** Copper alloy
- **Window:** Twist-lock polycarbonate
- **Window ring:** None
- **Dial:** White aluminum
- **Pointer:** Black aluminum
- **Case fill:** Not available
- **Accuracy:**  $\pm 3/2/3\%$  of span
- **UL Listed**
- **Datasheet:** 111.11



MECHANICAL PRESSURE

| Type              | 111.11   |                |                |                |                |
|-------------------|--|----------------|----------------|----------------|----------------|
| Size              | 1½"  | 2"             | 2½"            | 2"             | 2½"            |
| Case              | Gold-painted steel   |                |                | Polished brass |                |
| Connection        | LM  |                |                |                |                |
| Conn. size        | ½" NPT   | ¼" NPT         |                | ¼" NPT         |                |
| Press scale       | PSI  | PSI            | PSI            | PSI            | PSI            |
| <b>List price</b> | <b>\$30.90</b>   | <b>\$28.35</b> | <b>\$32.10</b> | <b>\$30.95</b> | <b>\$40.45</b> |
| 30" Hg            |  |                |                |                |                |
| 30"-0-15 psi      |  |                |                |                |                |
| 30"-0-30 psi      |  |                |                |                |                |
| 30"-0-60 psi      |  |                |                |                |                |
| 30"-0-100 psi     |  |                |                |                |                |
| 30"-0-160 psi     |  |                |                |                |                |
| 30"-0-200 psi     |  |                |                |                |                |
| <b>List price</b> | <b>\$25.10</b>   | <b>\$23.05</b> | <b>\$26.10</b> | <b>\$25.65</b> | <b>\$34.45</b> |
| 15 psi            |  |                |                |                |                |
| 30 psi            |  |                |                | <b>8611009</b> | 8610851        |
| 30 psi Red band   | 8079633  | 8985025        | 8985030        | 8611017        | 8610860        |
| 60 psi            |  |                |                | <b>8611025</b> | 8610878        |
| 100 psi           | 8079650  | 8985026        | 8985031        | <b>8611033</b> | 8610886        |
| 200 psi           |  | 8985027        | 8985032        | <b>8611041</b> | <b>8610894</b> |
| 400 psi           | 9735232  | 8985028        | 8985033        | <b>8611050</b> | <b>8610908</b> |
| 600 psi           |  |                |                | <b>8611076</b> | 8610924        |
| 1,000 psi         |  |                |                | 8611084        | 8610932        |
| <b>List price</b> | <b>\$28.70</b>   | <b>\$25.05</b> | <b>\$29.10</b> | <b>\$27.65</b> | <b>\$37.45</b> |
| 1,500 psi         |  |                |                |                |                |
| 2,000 psi         |  |                |                | 8611106        | 8610959        |
| 3,000 psi         |  |                |                | <b>8611122</b> | 8610967        |
| 4,000 psi         | 8079617  | 8985029        | <b>8985034</b> | <b>8611114</b> | <b>8610975</b> |
| 6,000 psi         | N/A  |                |                |                |                |

Items without part numbers are available - consult factory.

Factory stocked items shown in **bold print**

Items without part numbers are available - consult factory.

# GENERAL PURPOSE

Mechanical Pressure > General Purpose Gauges > Options for 111.11

## Options for type 111.11

| Option  | Code                           | 111.11<br>1½" LM | 111.11<br>2" LM | 111.11<br>2½" LM |
|---|--------------------------------|------------------|-----------------|------------------|
| <b>Case / ring options</b>                      |                                |                  |                 |                  |
| Black-painted steel                             | ST BLK                         | \$0.00           | \$0.00          | \$0.00           |
| Chrome-plated steel                             | ST CHR                         | \$3.40           | \$3.40          | \$3.40           |
| Chrome-plated brass                             | BR CHR                         | n/a              | \$4.75          | \$10.10          |
| <b>Connections</b>                              |                                |                  |                 |                  |
| 1/8" NPT or 1/4" NPT                            | 1/8" or 1/4"                   | \$0.00           | \$0.00          | \$0.00           |
| G1/8B or G1/4B                                  | G1/8B or G1/4B                 | \$0.00           | \$0.00          | \$0.00           |
| R1/8 or R1/4-ISO7                               | R1/8 or R1/4                   | \$2.60           | \$2.60          | \$2.60           |
| 7/16-20 SAE                                     | SAE                            | n/a              | \$8.10          | \$8.10           |
| Nickel-plated connection                        | NKL SKT                        | \$4.25           | \$4.25          | \$4.25           |
| 10-32 internal tap                              | 10-32                          | \$1.85           | \$1.85          | \$1.85           |
| Teflon® tape on connection                      | TT                             | \$0.70           | \$0.70          | \$0.70           |
| <b>Restrictors</b>                              |                                |                  |                 |                  |
| Brass, press-fit, 0.3mm orifice <sup>1</sup>    | R                              | \$2.00           | \$2.00          | \$2.00           |
| Brass, M5 thread, 0.5mm orifice                 | R0.5                           | \$2.75           | \$2.75          | \$2.75           |
| Sintered metal filter, brass                    | FLT                            | \$3.90           | \$3.90          | \$3.90           |
| Sintered metal filter, SS                       | FLT SS                         | \$4.70           | \$4.70          | \$4.70           |
| <b>Dials &amp; scales</b>                       |                                |                  |                 |                  |
| Dial, luminescent                               | LUM                            | \$4.45           | n/a             | n/a              |
| <b>Movements</b>                                |                                |                  |                 |                  |
| Silicone dampened movement                      | DAMP                           | \$2.45           | \$2.45          | \$2.45           |
| <b>Special accuracy / calibration</b>           |                                |                  |                 |                  |
| ±2/1/2% of span                                 | 2/1/2%                         | \$1.75           | \$1.75          | \$1.75           |
| <b>Other options available</b>                  |                                |                  |                 |                  |
| Calibration and material certificates           | <i>Refer to pages 261, 262</i> |                  |                 |                  |
| Special scales, logos and other artwork charges | <i>Refer to pages 263, 265</i> |                  |                 |                  |
| Needle valves, siphons and other accessories    | <i>Refer to pages 255-259</i>  |                  |                 |                  |

<sup>1</sup> Restrictor standard for ranges 1,500PSI and higher

Shaded options are non-standard and may require extended lead-times



# GENERAL PURPOSE

Mechanical Pressure > General Purpose Gauges > 111.16PM

## General Purpose Gauges - U-clamp Panel Mounting for US Size

### Standard features

- **Case:** Black plastic
- **Wetted parts:** Copper alloy
- **Window:** Snap-in acrylic
- **Dial:** White plastic
- **Profile Ring:** Stainless steel polished (1½"), standard chrome plated (2")
- **Pointer:** Black Plastic
- **Case fill:** Not available
- **Accuracy:** ±3/2/3% of span
- **Datasheet:** 111.16PM
- **U-Clamp:** Steel zinc plated

| Type                     | 111.16PM   |                |                |
|--------------------------|--|----------------|----------------|
| Size                     | 1½"  | 2"             |                |
| Connection               | CBM/UC  |                |                |
| Conn. size               | ½" NPT   | ½" NPT         | ¼" NPT         |
| Press scale <sup>1</sup> | PSI  | PSI            | PSI/KPA        |
| <b>List price</b>        | <b>\$25.05</b>   | <b>\$27.05</b> | <b>\$27.05</b> |
| 30" Hg                   | 4231279  | <b>4231341</b> | 4231422        |
| 30"-0-15 psi             |  |                |                |
| 30"-0-30 psi             |  |                |                |
| 30"-0-60 psi             |  |                |                |
| 30"-0-100 psi            |  |                |                |
| 30"-0-160 psi            |  |                |                |
| 30"-0-200 psi            |  |                |                |
| <b>List price</b>        | <b>\$23.05</b>   | <b>\$25.05</b> | <b>\$25.05</b> |
| 15 psi                   | 4231287  | 4231350        | 4231431        |
| 30 psi                   | <b>4231295</b>   | 4231368        | 4231449        |
| 60 psi                   | <b>4231309</b>   | 4231376        | 4231457        |
| 100 psi                  | <b>4231317</b>   | 4231384        | <b>4231465</b> |
| 160 psi                  | <b>4231325</b>   | <b>4231392</b> | 4231473        |
| 200 psi                  | 4231333  | 4231406        | 4231481        |
| 300 psi                  |  | 4231414        | 4231490        |
| 400 psi                  |  |                |                |
| 600 psi                  |  |                |                |
| <b>List price</b>        | <b>\$24.50</b>   | <b>\$26.55</b> | <b>\$26.55</b> |
| 800 psi                  |  |                |                |
| 1,000 psi                |  |                |                |
| 1,500 psi                |  |                |                |
| 2,000 psi                |  |                |                |
| 3,000 psi                |  |                |                |
| <b>List price</b>        | <b>\$25.95</b>   | <b>\$28.40</b> | <b>\$28.40</b> |
| 5,000 psi                |  |                |                |



<sup>1</sup>Vacuum scale: 30" Hg outside in black; 760 mm Hg inside in red.

Factory stocked items shown in **bold print**  
 Items without part numbers are available - consult factory.

# GENERAL PURPOSE

Mechanical Pressure > General Purpose Gauges > Options for 111.16PM

## Options for type 111.16PM

| Option  | Code                           | 111.16PM | 111.16PM |
|---|--------------------------------|----------|----------|
|   |                                | 1½" CBM  | 2" CBM   |
| <b>Case / ring options</b>                      |                                |          |          |
| Profile ring, SS crimped                        | SS PRNG                        | \$3.40   | \$3.40   |
| <b>Connections</b>                              |                                |          |          |
| 1/8" NPT or 1/4" NPT                            | 1/8" or 1/4"                   | \$0.00   | \$0.00   |
| G1/8B or G1/4B                                  | G1/8B or G1/4B                 | \$0.00   | \$0.00   |
| R1/8 or R1/4-ISO7                               | R1/8 or R1/4                   | \$2.60   | \$2.60   |
| 7/16-20 SAE                                     | SAE                            | n/a      | \$8.10   |
| Nickel-plated connection                        | NKL SKT                        | \$4.25   | \$4.25   |
| 10-32 internal tap                              | 10-32                          | \$1.85   | \$1.85   |
| Teflon® tape on connection                      | TT                             | \$0.70   | \$0.70   |
| <b>Restrictors</b>                              |                                |          |          |
| Brass, press-fit, 0.3mm orifice                 | R                              | \$2.00   | \$2.00   |
| Brass, M5 thread, 0.5mm orifice                 | R0.5                           | \$2.75   | \$2.75   |
| Sintered metal filter, brass                    | FLT                            | \$3.90   | \$3.90   |
| Sintered metal filter, SS                       | FLT SS                         | \$4.70   | \$4.70   |
| <b>Dials &amp; scales</b>                       |                                |          |          |
| Dial, aluminum white                            | DIAL AL                        | \$0.25   | \$0.25   |
| <b>Movements</b>                                |                                |          |          |
| Silicone dampened movement                      | DAMP                           | \$2.45   | \$2.45   |
| <b>Special accuracy / calibration</b>           |                                |          |          |
| ±2/1/2% of span                                 | 2/1/2%                         | \$1.75   | \$1.75   |
| <b>Other</b>                                    |                                |          |          |
| Clean for O2 service (ASME Level IV)            | O2                             | \$19.45  | \$19.45  |
| <b>Other options available</b>                  |                                |          |          |
| Calibration and material certificates           | <i>Refer to pages 261, 262</i> |          |          |
| Special scales, logos and other artwork charges | <i>Refer to pages 263, 265</i> |          |          |
| Needle valves, siphons and other accessories    | <i>Refer to pages 255-259</i>  |          |          |

Shaded options are non-standard and may require extended lead-times

# GENERAL PURPOSE

Mechanical Pressure > General Purpose Gauges > 111.25CT

## General Purpose Gauges - Contractor's Gauge

### Standard features

- **Case:** Stainless steel
- **Wetted parts:** Copper alloy
- **Window:** Snap-in acrylic
- **Window ring:** None
- **Dial:** White aluminum
- **Pointer:** Black aluminum
- **Case fill:** Not available
- **Accuracy:** ±1% of span
- **Datasheet:** 111.25CT

| Type                     | 111.25CT       |         |
|--------------------------|----------------|---------|
| Size                     | 4 1/2"         |         |
| Connection               | LM             |         |
| Conn. size               | 1/4" NPT       |         |
| Press scale <sup>1</sup> | PSI            | PSI/KPA |
| List price               | \$32.20        | \$32.20 |
| 30" Hg                   |                |         |
| 30"-0-15 psi             | 4277687        | 4277849 |
| 30"-0-30 psi             | 4277695        | 4277857 |
| 30"-0-60 psi             | 4277709        | 4277865 |
| 30"-0-100 psi            | 4277717        | 4277873 |
| 30"-0-160 psi            | 4277725        | 4277881 |
| 30"-0-200 psi            | 4277733        | 4277890 |
| 30"-0-300 psi            | 4277741        | 4277903 |
| 30"-0-400 psi            |                |         |
| List price               | \$32.20        | \$32.20 |
| 15 psi                   | 4277750        | 4277911 |
| 30 psi                   | <b>4277768</b> | 4277920 |
| 60 psi                   | <b>4277776</b> | 4277938 |
| 100 psi                  | <b>4277784</b> | 4277946 |
| 160 psi                  | <b>4277792</b> | 4277954 |
| 200 psi                  | <b>4277806</b> | 4277962 |
| 300 psi                  | <b>4277814</b> | 4277971 |
| 400 psi                  | 4277822        | 4277989 |
| 600 psi                  | 4277831        | 4277997 |

<sup>1</sup>Vacuum scale: 30" Hg outside in black; 760 mm Hg inside in red.

Factory stocked items shown in **bold print**  
Items without part numbers are available - consult factory.



# GENERAL PURPOSE

Mechanical Pressure > General Purpose Gauges > Options for 111.25CT

## Options for type 111.25CT

| Option  | Code                           | 111.25CT<br>4½" LM |
|---|--------------------------------|--------------------|
| <b>Case / ring options</b>                      |                                |                    |
| Black-painted steel                             | ST BLK                         | \$0.00             |
| <b>Connections</b>                              |                                |                    |
| 1/8" NPT or 1/4" NPT                            | 1/8" or 1/4"                   | \$0.00             |
| G1/4B   | G1/4B                          | \$0.00             |
| R1/4-ISO7                                       | R1/4                           | \$2.60             |
| Nickel-plated connection                        | NKL SKT                        | \$4.25             |
| 10-32 internal tap                              | 10-32                          | \$1.85             |
| Teflon® tape on connection                      | TT                             | \$0.70             |
| <b>Mounting</b>                                 |                                |                    |
| Rear flange, SS                                 | RF                             | \$18.45            |
| <b>Restrictors</b>                              |                                |                    |
| Brass, press-fit, 0.3mm orifice                 | R                              | \$2.00             |
| Brass, M5 thread, 0.5mm orifice                 | R0.5                           | \$2.75             |
| Sintered metal filter, brass                    | FLT                            | \$3.90             |
| Sintered metal filter, SS                       | FLT SS                         | \$4.70             |
| <b>Movements</b>                                |                                |                    |
| Silicone dampened movement                      | DAMP                           | \$2.45             |
| <b>Other</b>                                    |                                |                    |
| Clean for O2 service (ASME Level IV)            | O2                             | \$19.45            |
| <b>Other options available</b>                  |                                |                    |
| Calibration and material certificates           | <i>Refer to pages 261, 262</i> |                    |
| Special scales, logos and other artwork charges | <i>Refer to pages 263, 265</i> |                    |
| Needle valves, siphons and other accessories    | <i>Refer to pages 255-259</i>  |                    |

Shaded options are non-standard and may require extended lead-times

# GENERAL PURPOSE



Mechanical Pressure > General Purpose Gauges > 113.13

## General Purpose Gauges - ABS Case, Liquid-filled

### Standard features

- **Case:** Black ABS
- **Wetted parts:** Copper alloy
- **Window:** Acrylic
- **Window ring:** None
- **Dial:** White ABS
- **Pointer:** Black ABS
- **Case fill:** Glycerine
- **Accuracy:**  $\pm 3/2/3\%$  of span (1½" size)  
 $\pm 2/1/2\%$  of span (2" & 2½" sizes)
- **Datasheet:** 113.13



| Type                     | 113.13  |  |   |
|--------------------------|---|--|---|
| Size                     | 1½"   | 2½"  |   |
| Connection               | CBM  | LM  | CBM  |
| Conn. size               | ½" NPT  | ¼" NPT   |   |
| Press scale <sup>1</sup> | PSI   | PSI  | PSI   |
| <b>List price</b>        | <b>\$33.25</b>  | <b>\$35.50</b>   | <b>\$37.45</b>  |
| 30" Hg                   |   | 9677909  | 9693289   |
| 30"-0-15 psi             |   |  |   |
| 30"-0-30 psi             |   | 9677925  |   |
| 30"-0-60 psi             |   | 9677933  |   |
| 30"-0-100 psi            |   | 9677941  |   |
| 30"-0-160 psi            |   | 9677950  |   |
| 30"-0-200 psi            |   | 9677968  |   |
| <b>List price</b>        | <b>\$32.00</b>  | <b>\$34.05</b>   | <b>\$36.00</b>  |
| 15 psi                   | 4230233   | <b>9677976</b>   | 9693351   |
| 30 psi                   | <b>9738240</b>  | <b>9677984</b>   | 9693360   |
| 60 psi                   | <b>9738258</b>  | <b>9677992</b>   | <b>9693378</b>  |
| 100 psi                  | <b>9738266</b>  | <b>9678000</b>   | 9693386   |
| 160 psi                  | <b>9738274</b>  | <b>9678018</b>   | <b>9693394</b>  |
| 200 psi                  | 50603027  | <b>9693726</b>   | 9693408   |
| 300 psi                  | 50603035  | <b>9693734</b>   | 9693416   |
| 400 psi                  |   | 9693742  | 9693424   |
| 600 psi                  |   | <b>9693750</b>   | 9693432   |
| 800 psi                  |   |  |   |
| 1,000 psi                | 50983556  | <b>9693777</b>   | 9693459   |
| <b>List price</b>        | <b>\$35.80</b>  | <b>\$39.85</b>   | <b>\$41.80</b>  |
| 1,500 psi                | 50078054  | 9693785  | 9693467   |
| 2,000 psi                |   | 9693793  | 9693475   |
| 3,000 psi                |   | <b>9693807</b>   | 9693483   |
| <b>List price</b>        | <b>\$38.70</b>  | <b>\$41.80</b>   | <b>\$43.75</b>  |
| 5,000 psi                | 50078062  | <b>9693815</b>   | 9693491   |

<sup>1</sup> Vacuum scale: 30" Hg outside in black; 760 mm Hg inside in red.

Factory stocked items shown in **bold print**  
Items without part numbers are available - consult factory.

# GENERAL PURPOSE

Mechanical Pressure > General Purpose Gauges > Options for 113.13

## Options for type 113.13

| Option  | Code                           | 113.13<br>1½" CBM | 113.13<br>2½" LM | 113.13<br>2½" CBM |
|---|--------------------------------|-------------------|------------------|-------------------|
| <b>Case liquid fills</b>                        |                                |                   |                  |                   |
| Glycerine / water (86.5 / 13.5)                 | GLY86.5                        | \$6.20            | \$6.20           | \$6.20            |
| Silicone 1,000 cst                              | SIL1000                        | \$12.85           | \$12.85          | \$12.85           |
| Silicone 50 cst                                 | SIL50                          | \$12.85           | \$12.85          | \$12.85           |
| Silicone 350 cst                                | SIL350                         | \$12.85           | \$12.85          | \$12.85           |
| <b>Connections</b>                              |                                |                   |                  |                   |
| 1/8" NPT or 1/4" NPT                            | 1/8" x 1/4"                    | \$0.00            | \$0.00           | \$0.00            |
| G1/8B or G1/4B                                  | G1/8B or G1/4B                 | \$0.00            | \$0.00           | \$0.00            |
| R1/8 or R1/4-ISO7                               | R1/8 or R1/4                   | \$2.60            | \$2.60           | \$2.60            |
| Nickel-plated connection                        | NKL SKT                        | \$4.25            | \$4.25           | \$4.25            |
| 10-32 internal tap                              | 10-32                          | \$1.85            | \$1.85           | \$1.85            |
| Teflon® tape on connection                      | TT                             | \$0.70            | \$0.70           | \$0.70            |
| <b>Mounting</b>                                 |                                |                   |                  |                   |
| Front flange, black ABS                         | FF                             | n/a               | n/a              | \$6.70            |
| U-clamp, steel bracket                          | UC                             | n/a               | n/a              | \$11.55           |
| <b>Pointers</b>                                 |                                |                   |                  |                   |
| Black aluminum                                  | PNTR AL                        | \$0.25            | \$0.25           | \$0.25            |
| <b>Restrictors</b>                              |                                |                   |                  |                   |
| Brass, press-fit, 0.3mm orifice                 | R                              | \$3.90            | \$3.90           | \$3.90            |
| Brass, M5 thread, 0.5mm orifice                 | R0.5                           | \$4.90            | \$4.90           | \$4.90            |
| Sintered metal filter, brass                    | FLT                            | \$5.75            | \$5.75           | \$5.75            |
| Sintered metal filter, SS                       | FLT SS                         | \$6.05            | \$6.05           | \$6.05            |
| <b>Dials &amp; scales</b>                       |                                |                   |                  |                   |
| Dial, aluminum white                            | DIAL AL                        | \$0.25            | \$0.25           | \$0.25            |
| Dial, luminescent                               | LUM                            | n/a               | \$4.45           | \$4.45            |
| <b>Other options available</b>                  |                                |                   |                  |                   |
| Calibration and material certificates           | <i>Refer to pages 261, 262</i> |                   |                  |                   |
| Special scales, logos and other artwork charges | <i>Refer to pages 263, 265</i> |                   |                  |                   |
| Needle valves, siphons and other accessories    | <i>Refer to pages 255-259</i>  |                   |                  |                   |

Shaded options are non-standard and may require extended lead-times

# GENERAL PURPOSE

Mechanical Pressure > General Purpose Gauges > 113.53

## General Purpose Gauges - SS Case, Liquid-filled

### Standard features

- **Case:** Stainless steel
- **Wetted parts:** Copper alloy
- **Window:** Acrylic
- **Window ring:** SS, crimped
- **Dial:** White aluminum
- **Pointer:** Black aluminum
- **Case fill:** Glycerine
- **Accuracy:**  $\pm 2.5\%$  of span
- **Datasheet:** 113.53

| Type                     | 113.53   |   |  |
|--------------------------|--|---|--|
| Size                     | 1 1/2"   |   |  |
| Connection               | LM  | CBM  | CBM/UC  |
| Conn. size               | 1/8" NPT   |   |  |
| Press scale <sup>1</sup> | PSI  | PSI   | PSI  |
| <b>List price</b>        | <b>\$34.60</b>   | <b>\$34.60</b>  | <b>\$41.05</b>   |
| 30" Hg                   | 50702424   | 50701525  | 50700821   |
| 30"-0-15 psi             | 50702432   | 50701533  | 50700847   |
| 30"-0-30 psi             | 50702441   | 50701541  | 50700855   |
| 30"-0-60 psi             | 50702459   | 50701550  | 50700863   |
| 30"-0-100 psi            | 50702467   | 50701568  | 50700871   |
| 30"-0-160 psi            | 50702475   | 50701576  | 50700880   |
| 30"-0-200 psi            | 50702483   | 50701584  | 50700898   |
| <b>List price</b>        | <b>\$32.95</b>   | <b>\$32.95</b>  | <b>\$38.40</b>   |
| 15 psi                   | 50702491   | 50701592  | 50700901   |
| 30 psi                   | 50702505   | 50701606  | 50700910   |
| 60 psi                   | 50702513   | 50701614  | 50700928   |
| 100 psi                  | 50702521   | 50701622  | 50700936   |
| 160 psi                  | 50702530   | 50701631  | 50700944   |
| 200 psi                  | 50702548   | 50701649  | 50700952   |
| 300 psi                  | 50702556   | 50701657  | 50700961   |
| 400 psi                  | 50702564   | 50701665  | 50700979   |
| 600 psi                  | 50702572   | 50701673  | 50700987   |
| 800 psi                  |  |   |  |
| 1,000 psi                | 50702581   | 50701681  | 50700995   |
| <b>List price</b>        | <b>\$36.30</b>   | <b>\$36.30</b>  | <b>\$41.85</b>   |
| 1,500 psi                | 50702599   | 50701690  | 50701002   |
| 2,000 psi                | 50702602   | 50701703  | 50701011   |
| 3,000 psi                | 50702611   | 50701711  | 50701029   |
| 5,000 psi                | 50702629   | 50701720  | 50701061   |

<sup>1</sup> Vacuum scale: 30" Hg outside in black; 760 mm Hg inside in red.

Factory stocked items shown in **bold print**  
Items without part numbers are available - consult factory.



# GENERAL PURPOSE

Mechanical Pressure > General Purpose Gauges > Options for 113.53

## Options for type 113.53

| Option  | Code         | 113.53<br>1½" LM               | 113.53<br>1½" CBM | 113.53<br>1½" CBM/UC |
|---|--------------|--------------------------------|-------------------|----------------------|
| <b>Case liquid fills</b>                        |              |                                |                   |                      |
| Glycerine / water (86.5 / 13.5)                 | GLY86.5      | \$6.20                         | \$6.20            | \$6.20               |
| Silicone 50 cst                                 | SIL50        | \$12.85                        | \$12.85           | \$12.85              |
| <b>Connections</b>                              |              |                                |                   |                      |
| G1/8B or G1/4B                                  | G1/8 or G1/4 | \$0.00                         | \$0.00            | \$0.00               |
| R1/8 or R1/4-ISO7                               | R1/8 or R1/4 | \$2.60                         | \$2.60            | \$2.60               |
| Zinc-plated connection                          | NKL SKT      | \$6.40                         | \$6.40            | \$6.40               |
| 10-32 internal tap                              | 10-32        | \$1.85                         | \$1.85            | \$1.85               |
| Teflon® tape on connection                      | TT           | \$0.70                         | \$0.70            | \$0.70               |
| <b>Restrictors</b>                              |              |                                |                   |                      |
| Brass, press-fit, 0.3mm orifice                 | R            | \$3.90                         | \$3.90            | \$3.90               |
| Brass, M5 thread, 0.5mm orifice                 | R0.5         | \$4.90                         | \$4.90            | \$4.90               |
| Sintered metal filter, brass                    | FLT          | \$5.75                         | \$5.75            | \$5.75               |
| Sintered metal filter, SS                       | FLT SS       | \$6.05                         | \$6.05            | \$6.05               |
| <b>Other options available</b>                  |              |                                |                   |                      |
| Calibration and material certificates           |              | <i>Refer to pages 261, 262</i> |                   |                      |
| Special scales, logos and other artwork charges |              | <i>Refer to pages 263, 265</i> |                   |                      |
| Needle valves, siphons and other accessories    |              | <i>Refer to pages 255-259</i>  |                   |                      |

Shaded options are non-standard and may require extended lead-times



# INDUSTRIAL GAUGES

Mechanical Pressure > Industrial Gauges > 131.11

## Industrial Gauges - SS Case, SS Wetted Parts

### Standard features

- **Case:** 304 SS
- **Wetted parts:** 316L SS
- **Window:** Acrylic
- **Window ring:** None
- **Dial:** White aluminum
- **Pointer:** Black aluminum
- **Case fill:** None
- **Accuracy:** ±2.5% of span
- **Datasheet:** 131.11



MECHANICAL PRESSURE

| Type                     | 131.11         |                |                |                |                |                |
|--------------------------|----------------|----------------|----------------|----------------|----------------|----------------|
| Size                     | 1½"            |                | 2"             |                |                |                |
| Connection               | LM             | CBM            | LM             | CBM            | LM             | CBM            |
| Conn. size               | ½" NPT         |                | ½" NPT         |                | ¼" NPT         |                |
| Press scale <sup>1</sup> | PSI            | PSI            | PSI            | PSI            | PSI            | PSI            |
| <b>List price</b>        | <b>\$77.45</b> | <b>\$86.05</b> | <b>\$64.65</b> | <b>\$71.80</b> | <b>\$64.65</b> | <b>\$71.80</b> |
| 30" Hg                   | N/A            | N/A            |                |                |                |                |
| 30"-0-15 psi             |                | 50099183       |                |                | 8993241        | 8993259        |
| 30"-0-30 psi             | 50079441       | 50872311       | 50100289       |                |                |                |
| 30"-0-60 psi             | 50079450       | 50099191       |                |                | 8993267        | 8993275        |
| 30"-0-100 psi            |                |                | 50100301       |                | 8993284        | 8993292        |
| 30"-0-160 psi            | 50079476       |                | 50100319       |                | 8993305        | 8993314        |
| 30"-0-200 psi            |                |                |                |                |                |                |
| <b>List price</b>        | <b>\$71.70</b> | <b>\$80.30</b> | <b>\$59.65</b> | <b>\$66.80</b> | <b>\$59.65</b> | <b>\$66.80</b> |
| 15 psi                   | 50079492       | 50025228       |                |                | 4232120        | 50100980       |
| 30 psi                   | 9117946        | <b>9118128</b> | 9118063        | <b>9117970</b> | 9118039        | 9117903        |
| 60 psi                   | 9117938        | <b>9118101</b> | 9118071        | 9117989        | <b>9118020</b> | 9117890        |
| 100 psi                  | 9117920        | <b>9118098</b> | 9118055        | 9117962        | <b>9118012</b> | 9117881        |
| 160 psi                  | 9117911        | <b>9118080</b> | 9118047        | 9117954        | 9117997        | <b>9117865</b> |
| 200 psi                  | 50079506       | 9192522        |                | 50951131       |                | 8999835        |
| 300 psi                  | 50079514       | 4302621        |                | 50100769       | 50100882       | 8999851        |
| 400 psi                  | 8995260        | 4218630        |                | 50561294       |                |                |
| 600 psi                  | 50079531       | 9176640        |                | 50648039       | 9206213        |                |
| 800 psi                  |                |                |                |                | 50100912       | 8993330        |
| <b>List price</b>        | <b>\$73.90</b> | <b>\$82.50</b> | <b>\$61.95</b> | <b>\$69.10</b> | <b>\$61.95</b> | <b>\$69.10</b> |
| 1,000 psi                |                | 50009711       |                |                | 52207943       |                |
| 1,500 psi                | 50079565       | 50100254       |                |                |                |                |
| 2,000 psi                | 50856529       | 50009690       | 50100416       | 50100823       |                |                |
| 3,000 psi                | 50079581       | 50009702       | 50100424       | 50100831       | 8993348        | 8993356        |
| 5,000 psi                |                | 50100262       |                |                | 50596535       |                |
| 10,000 psi               | 52023427       | 52001547       | 50913883       | 50833731       |                |                |

<sup>1</sup> Vacuum scale: 30" Hg outside in black; 760 mm Hg inside in red.

Factory stocked items shown in **bold print**  
Items without part numbers are available - consult factory.

# INDUSTRIAL GAUGES

Mechanical Pressure > Industrial Gauges > Options for 131.11

## Options for type 131.11

| Option  | Code                    | 131.11<br>1½" LM | 131.11<br>1½" CBM | 131.11<br>2" LM | 131.11<br>2" CBM |
|---|-------------------------|------------------|-------------------|-----------------|------------------|
| <b>Case / ring options</b>                      |                         |                  |                   |                 |                  |
| SS case with blowout plug                       | SS BO                   | \$4.80           | \$4.80            | \$4.80          | \$4.80           |
| Friction ring, SS matte-finish                  | FR SS                   | \$7.15           | \$7.15            | \$7.15          | \$7.15           |
| Friction ring, SS chrome-plated                 | FR CHR                  | \$9.95           | \$9.95            | \$9.95          | \$9.95           |
| <b>Connections</b>                              |                         |                  |                   |                 |                  |
| 1/8" NPT or 1/4" NPT                            | 1/8" x 1/4"             | \$0.00           | \$0.00            | \$0.00          | \$0.00           |
| G1/8B or G1/4B                                  | G1/8B or G1/4B          | \$0.00           | \$0.00            | \$0.00          | \$0.00           |
| R1/8 or R1/4-ISO7                               | R1/8 or R1/4            | \$2.65           | \$2.65            | \$2.65          | \$2.65           |
| 10-32 internal tap                              | 10-32                   | \$1.90           | \$1.90            | \$1.90          | \$1.90           |
| Teflon® tape on connection                      | TT                      | \$0.70           | \$0.70            | \$0.70          | \$0.70           |
| <b>Mounting</b>                                 |                         |                  |                   |                 |                  |
| Front flange, SS polished                       | FF                      | n/a              | \$26.30           | n/a             | \$26.30          |
| U-clamp, pol SS ring, steel bracket             | UC                      | n/a              | \$19.25           | n/a             | \$19.25          |
| <b>Windows</b>                                  |                         |                  |                   |                 |                  |
| Flat glass (add friction ring)                  | GLS                     | \$3.50           | \$3.50            | \$3.50          | \$3.50           |
| Safety glass (add friction ring)                | SG                      | \$4.30           | \$4.30            | \$4.30          | \$4.30           |
| <b>Restrictors</b>                              |                         |                  |                   |                 |                  |
| SS, M4 threads, 0.6mm orifice                   | R                       | \$7.15           | \$7.15            | \$7.15          | \$7.15           |
| Sintered metal filter, SS                       | FLT SS                  | \$7.15           | \$7.15            | \$7.15          | \$7.15           |
| <b>Dials &amp; scales</b>                       |                         |                  |                   |                 |                  |
| Dial, luminescent                               | LUM                     | \$4.55           | \$4.55            | n/a             | n/a              |
| <b>Special accuracy / calibration</b>           |                         |                  |                   |                 |                  |
| ±2/1/2% of span                                 | 2/1/2%                  | \$1.80           | \$1.80            | \$1.80          | \$1.80           |
| <b>Other</b>                                    |                         |                  |                   |                 |                  |
| Clean for O2 service (ASME Level IV)            | O2                      | \$20.60          | \$20.60           | \$20.60         | \$20.60          |
| Serial number on dial                           | SER#                    | \$3.50           | \$3.50            | \$3.50          | \$3.50           |
| <b>Other options available</b>                  |                         |                  |                   |                 |                  |
| Calibration and material certificates           | Refer to pages 261, 262 |                  |                   |                 |                  |
| Special scales, logos and other artwork charges | Refer to pages 263, 265 |                  |                   |                 |                  |
| Needle valves, siphons and other accessories    | Refer to pages 255-259  |                  |                   |                 |                  |

Shaded options are non-standard and may require extended lead-times

# INDUSTRIAL GAUGES

Mechanical Pressure > Industrial Gauges > 13X.53

## Industrial Gauges - Economy SS Gauge

### Standard features

- **Case:** 304 SS
- **Wetted parts:** 316L SS
- **Window:** Acrylic
- **Window ring:** SS, crimped
- **Dial:** White aluminum
- **Pointer:** Black aluminum
- **Case fill:** None, fillable
- **Accuracy:**  $\pm 3/2/3\%$  of span
- **Datasheet:** 13X.53



| Type                     | 13X.53   |                 |
|--------------------------|--|-----------------|
| Size                     | 4"   |                 |
| Connection               | LM  |                 |
| Conn. size               | 1/4" NPT   | 1/2" NPT        |
| Press scale <sup>1</sup> | PSI  | PSI             |
| <b>List price</b>        | <b>\$92.25</b>   | <b>\$92.25</b>  |
| 30 psi                   | 4285329  | 4285477         |
| 60 psi                   | 4285337  | 4285485         |
| 100 psi                  | 4285345  | 4285493         |
| 160 psi                  | 4285353  | 4285507         |
| 200 psi                  | 4285361  | 4285515         |
| 300 psi                  | 4285370  | 4285523         |
| 400 psi                  | 4285388  | 4285531         |
| 600 psi                  | 4285396  | 4285540         |
| 800 psi                  |  |                 |
| 1,000 psi                | 4285400  | 4285558         |
| <b>List price</b>        | <b>\$96.40</b>   | <b>\$96.40</b>  |
| 1,500 psi                | 4285418  | 4285566         |
| 2,000 psi                | 4285426  | 4285574         |
| 3,000 psi                | 4285434  | 4285582         |
| 5,000 psi                | 4285442  | 4285591         |
| 10,000 psi               | 4285451  | 4285604         |
| <b>List price</b>        | <b>\$117.25</b>  | <b>\$117.25</b> |
| 15,000 psi               | 4285469  | 4285612         |

<sup>1</sup> Vacuum scale: 30" Hg outside in black; 760 mm Hg inside in red.

Factory stocked items shown in **bold print**

Items without part numbers are available - consult factory.

# INDUSTRIAL GAUGES

Mechanical Pressure > Industrial Gauges > Options for 13X.53

## Options for type 13X.53

| Option  | Code                           | 132.53<br>4" LM |
|---|--------------------------------|-----------------|
| <b>Case / ring options</b>                      |                                |                 |
| Glycerine                                       | 133.53                         | \$16.50         |
| Glycerine / water (86.5 / 13.5)                 | GLY86.5                        | \$20.70         |
| Silicone 1,000 cst                              | SIL1000                        | \$34.40         |
| Silicone 50 cst                                 | SIL50                          | \$34.40         |
| Silicone 350 cst                                | SIL350                         | \$34.40         |
| <b>Connections</b>                              |                                |                 |
| 1/4" NPT or 1/2" NPT                            | 1/4" or 1/2"                   | \$0.00          |
| G1/4B or G1/2B                                  | G1/4B or G1/2B                 | \$0.00          |
| 3, 9 or 12 O'clock connection                   | (3,9,12) CLK                   | \$9.25          |
| 10-32 internal tap                              | 10-32                          | \$1.90          |
| Teflon® tape on connection                      | TT                             | \$0.70          |
| <b>Mounting</b>                                 |                                |                 |
| Rear flange, SS                                 | RF                             | \$23.75         |
| <b>Restrictors</b>                              |                                |                 |
| SS, M4 threads, 0.6mm orifice                   | R                              | \$7.00          |
| <b>Other</b>                                    |                                |                 |
| Clean for O2 service (ASME Level IV)            | O2                             | \$20.60         |
| <b>Other options available</b>                  |                                |                 |
| Calibration and material certificates           | <i>Refer to pages 261, 262</i> |                 |
| Special scales, logos and other artwork charges | <i>Refer to pages 263, 265</i> |                 |
| Needle valves, siphons and other accessories    | <i>Refer to pages 255-259</i>  |                 |

Shaded options are non-standard and may require extended lead-times

# INDUSTRIAL GAUGES

Mechanical Pressure > Industrial Gauges > 211.11

## Industrial Gauges - Large 10" Dial Size

### Standard features

- **Case:** Black-painted steel
- **Wetted parts:** Copper alloy
- **Window:** Flat glass
- **Window ring:** Black-painted steel
- **Dial:** White aluminum
- **Pointer:** Black aluminum, adjustable
- **Case fill:** None
- **Accuracy:**  $\pm 1\%$  of span
- **Datasheet:** 2X1.11

|                                |  |
|--------------------------------|--|
| <b>Type</b>                    | <b>211.11</b>  |
| <b>Size</b>                    | <b>10"</b>   |
| <b>Connection</b>              | LM  |
| <b>Conn. size</b>              | 1/2" NPT   |
| <b>Press scale<sup>1</sup></b> | PSI/BAR  |
| <b>List price</b>              | <b>\$516.00</b>  |
| 30" Hg                         | 52092151   |
| 30"-0-15 psi                   |  |
| 30"-0-30 psi                   | 50662155   |
| 30"-0-60 psi                   |  |
| 30"-0-100 psi                  | 50081730   |
| 30"-0-160 psi                  |  |
| 30"-0-200 psi                  |  |
| <b>List price</b>              | <b>\$486.00</b>  |
| 15 psi                         |  |
| 30 psi                         | 4273193  |
| 60 psi                         | 50081764   |
| 100 psi                        | 4273214  |
| 160 psi                        |  |
| 200 psi                        | 4273231  |
| 300 psi                        | 4273240  |
| 400 psi                        | 4273258  |
| 600 psi                        | 4273266  |
| 800 psi                        | 4273274  |
| 1,000 psi                      | 4273282  |
| <b>List price</b>              | <b>\$560.00</b>  |
| 1,500 psi                      |  |
| 2,000 psi                      | 4273303  |
| 3,000 psi                      | 50081799   |
| 5,000 psi                      | 4273321  |
| <b>List price</b>              | <b>\$646.00</b>  |
| 10,000 psi                     |  |
| 15,000 psi                     |  |



# INDUSTRIAL GAUGES

Mechanical Pressure > Industrial Gauges > Options for 211.11

## Options for type 211.11

| Option  | Code                           | 211.11<br>10" LM |
|---|--------------------------------|------------------|
| <b>Connections</b>                              |                                |                  |
| G1/2B   | G1/2                           | \$0.00           |
| Lower back mount (LBM) connection               | LBM                            | \$36.20          |
| 10-32 internal tap                              | 10-32                          | \$1.90           |
| Teflon® tape on connection                      | TT                             | \$0.70           |
| <b>Mounting</b>                                 |                                |                  |
| Front flange, black-painted steel               | FF                             | \$145.25         |
| Rear flange, black-painted steel                | RF                             | \$139.25         |
| <b>Windows</b>                                  |                                |                  |
| Safety glass                                    | SG                             | \$45.60          |
| <b>Pointers</b>                                 |                                |                  |
| Red mark pointer on window                      | MP                             | \$117.60         |
| Red drag pointer on window                      | DP                             | \$121.75         |
| <b>Restrictors</b>                              |                                |                  |
| SS, M4 threads, 0.6mm orifice                   | R                              | \$7.15           |
| Sintered metal filter, SS                       | FLT SS                         | \$7.15           |
| <b>Other</b>                                    |                                |                  |
| Clean for O2 service (ASME Level IV)            | O2                             | \$20.60          |
| 316L SS wetted parts                            | 231.11                         | \$252.10         |
| <b>Other options available</b>                  |                                |                  |
| Calibration and material certificates           | <i>Refer to pages 261, 262</i> |                  |
| Special scales, logos and other artwork charges | <i>Refer to pages 263, 265</i> |                  |
| Needle valves, siphons and other accessories    | <i>Refer to pages 255-259</i>  |                  |

Shaded options are non-standard and may require extended lead-times

# INDUSTRIAL GAUGES

Mechanical Pressure > Industrial Gauges > 212.20

## Industrial Gauges - SS Case, Brass Wetted Parts

### Standard features

- **Case:** 304 SS
- **Wetted parts:** Copper alloy
- **Window:** Flat glass
- **Window ring:** 304 SS, bayonet
- **Dial:** White aluminum
- **Pointer:** Black aluminum, adjustable
- **Case fill:** None
- **Accuracy:** ±1% of span
- **Datasheet:** 212.20

|                                |  |
|--------------------------------|--|
| <b>Type</b>                    | <b>212.20</b>  |
| <b>Size</b>                    | <b>6"</b>  |
| <b>Connection</b>              | LM  |
| <b>Conn. size</b>              | ½" NPT   |
| <b>Press scale<sup>1</sup></b> | PSI  |
| <b>List price</b>              | <b>\$284.00</b>  |
| 30" Hg                         | 4287836  |
| 30"-0-15 psi                   |  |
| 30"-0-30 psi                   | 4287844  |
| 30"-0-60 psi                   |  |
| 30"-0-100 psi                  |  |
| 30"-0-160 psi                  |  |
| 30"-0-200 psi                  |  |
| <b>List price</b>              | <b>\$258.00</b>  |
| 15 psi                         | 4287852  |
| 30 psi                         | 4287861  |
| 60 psi                         | 4287879  |
| 100 psi                        | 4287887  |
| 160 psi                        | 4287895  |
| 200 psi                        | 4287909  |
| 300 psi                        | 4287917  |
| 400 psi                        | 4287925  |
| 600 psi                        | 4287933  |
| 800 psi                        |  |
| 1,000 psi                      | 4287941  |
| <b>List price</b>              | <b>\$338.00</b>  |
| 1,500 psi                      | 4287950  |
| 2,000 psi                      | 4287968  |
| 3,000 psi                      | 4287976  |
| 5,000 psi                      | 4287984  |
| <b>List price</b>              | <b>\$382.00</b>  |
| 10,000 psi                     | 4287992  |
| 15,000 psi                     | 4288000  |



<sup>1</sup> Vacuum scale: 30" Hg outside in black; 760 mm Hg inside in red.

# INDUSTRIAL GAUGES

Mechanical Pressure > Industrial Gauges > Options for 212.20

## Options for type 212.20

| Option  | Code                           | 212.20<br>6" LM |
|---|--------------------------------|-----------------|
| <b>Connections</b>                              |                                |                 |
| G1/2B   | G1/2                           | \$0.00          |
| 10-32 internal tap                              | 10-32                          | \$1.90          |
| Teflon® tape on connection                      | TT                             | \$0.70          |
| <b>Mounting</b>                                 |                                |                 |
| Front flange, SS                                | FF                             | \$86.65         |
| Rear flange, SS                                 | RF                             | \$63.60         |
| U-clamp, polished SS ring and SS bracket        | UC                             | \$64.50         |
| 3, 9 or 12 o'clock mounting                     | (3,9,12)CLK                    | \$31.05         |
| <b>Windows</b>                                  |                                |                 |
| Safety glass                                    | SG                             | \$20.20         |
| Polycarbonate                                   | PC                             | \$18.30         |
| <b>Pointers</b>                                 |                                |                 |
| Red mark pointer on window                      | MP                             | \$15.55         |
| Red drag pointer on window                      | DP                             | \$96.10         |
| <b>Restrictors</b>                              |                                |                 |
| SS, M4 threads, 0.6mm orifice                   | R                              | \$7.15          |
| Sintered metal filter, SS                       | FLT SS                         | \$7.15          |
| <b>Movement</b>                                 |                                |                 |
| Silicone dampened movement                      | DAMP                           | \$33.80         |
| <b>Other</b>                                    |                                |                 |
| Clean for O2 service (ASME Level IV)            | O2                             | \$31.20         |
| Accuracy ± 0.5% of span                         | 0.5%                           | \$22.75         |
| <b>Other options available</b>                  |                                |                 |
| Calibration and material certificates           | <i>Refer to pages 261, 262</i> |                 |
| Special scales, logos and other artwork charges | <i>Refer to pages 263, 265</i> |                 |
| Needle valves, siphons and other accessories    | <i>Refer to pages 255-259</i>  |                 |

Shaded options are non-standard and may require extended lead-times



# INDUSTRIAL GAUGES

Mechanical Pressure > Industrial Gauges > 213.40

## Industrial Gauges - Forged Brass Case, Liquid-filled

### Standard features

- **Case:** Forged brass
- **Wetted parts:** Copper alloy
- **Window:** Acrylic
- **Window ring:** SS, crimped
- **Dial:** White aluminum
- **Pointer:** Black aluminum
- **Case fill:** Glycerine
- **Accuracy:** ±2/1/2% of span (2½" size)  
±1% of span (4" size)
- **Datasheet:** 213.40



MECHANICAL PRESSURE

| Type                     | 213.40         |                |                |                |                |                |                 |                 |                 |                 |
|--------------------------|----------------|----------------|----------------|----------------|----------------|----------------|-----------------|-----------------|-----------------|-----------------|
| Size                     | 2½"            |                |                |                |                |                | 4"              |                 |                 |                 |
| Connection               | LM             |                |                | CBM            |                |                | LM              |                 | LBM             |                 |
| Conn. size               | ¼" NPT         |                |                |                |                |                | ¼" NPT          | ½" NPT          | ¼" NPT          | ½" NPT          |
| Press scale <sup>1</sup> | PSI            | PSI/KPA        | PSI/BAR        | PSI            | PSI/KPA        | PSI/BAR        | PSI             | PSI             | PSI             | PSI             |
| <b>List price</b>        | <b>\$71.75</b> | <b>\$71.75</b> | <b>\$71.75</b> | <b>\$74.85</b> | <b>\$74.85</b> | <b>\$74.85</b> | <b>\$177.80</b> | <b>\$177.80</b> | <b>\$192.05</b> | <b>\$192.05</b> |
| 30" Hg                   | <b>9318003</b> | 9456198        | 9734109        | 9318070        | 9455930        | 9734312        | 9314555         |                 | 9314296         |                 |
| 30"-0-15 psi             | 9318011        | 9613862        |                | 9318089        | 9325662        |                | 9314563         |                 | 9314300         |                 |
| 30"-0-30 psi             | <b>9318020</b> | 9456163        |                | 9318097        | 9325689        |                | 9314571         |                 | 9314318         |                 |
| 30"-0-60 psi             | <b>9318038</b> | 9456201        |                | 9318100        | 9325816        |                | 9314580         |                 | 9314326         |                 |
| 30"-0-100 psi            | 9318046        | 9679928        |                | 9318119        | 9149872        |                | 9314598         |                 | 9314334         |                 |
| 30"-0-160 psi            | 9318054        | 9679936        |                | 9318127        | 9325972        |                | 9314601         |                 | 9314342         |                 |
| 30"-0-200 psi            | 9318062        | 9442863        |                | 9318135        | 9326251        |                | 9314610         |                 | 9314350         |                 |
| <b>List price</b>        | <b>\$68.40</b> | <b>\$68.40</b> | <b>\$68.40</b> | <b>\$71.50</b> | <b>\$71.50</b> | <b>\$71.50</b> | <b>\$174.45</b> | <b>\$174.45</b> | <b>\$188.70</b> | <b>\$188.70</b> |
| 15 psi                   | <b>9310673</b> | 9456155        | 9734117        | 9318143        | 9455949        | 9734215        | 9314644         | 9314121         | 9314385         |                 |
| 30 psi                   | <b>9310681</b> | 9456171        | 9734125        | 9318151        | 9455957        | 9734223        | 9314652         | 9314130         | 9314393         |                 |
| 60 psi                   | <b>9310690</b> | 9456210        | 9734134        | <b>9318160</b> | 9455965        | 9734231        | 9314660         | 9314148         | 9314407         |                 |
| 100 psi                  | <b>9310703</b> | 9456228        | 9734142        | <b>9318178</b> | 9456120        | 9746072        | <b>9314679</b>  | <b>9314156</b>  | 9314415         |                 |
| 160 psi                  | <b>9310711</b> | 9456180        | 8986216        | <b>9318186</b> | 9455981        | 9734257        | 9314687         | 9314164         | 9314423         |                 |
| 200 psi                  | <b>9310720</b> | 9456236        |                | <b>9318194</b> | 9442979        |                | 9314695         | <b>9314172</b>  | 9314431         |                 |
| 300 psi                  | <b>9310738</b> | 9442871        | 9798870        | 9318208        | 9442987        | 9734265        | 9314709         | <b>9314180</b>  | 9314440         |                 |
| 400 psi                  | <b>9310746</b> | 9611452        |                | 9318216        | 9455990        |                | 9314717         | <b>9314199</b>  | 9314458         |                 |
| 600 psi                  | <b>9310754</b> | <b>9456244</b> | 8985815        | 9318224        | 9456007        | 8985774        | 9314725         | <b>9314202</b>  | 9314466         |                 |
| 800 psi                  | 9310762        | 9690115        |                | 9318232        | 9128832        |                | 9314733         | 9314210         | 9314474         |                 |
| 1,000 psi                | <b>9310770</b> | 9456252        | 9798404        | <b>9318240</b> | 9456015        | 9746048        | 9314741         | <b>9314229</b>  | 9314482         |                 |
| <b>List price</b>        | <b>\$76.00</b> | <b>\$76.00</b> | <b>\$76.00</b> | <b>\$79.10</b> | <b>\$79.10</b> | <b>\$79.10</b> | <b>\$190.30</b> | <b>\$190.30</b> | <b>\$204.55</b> | <b>\$204.55</b> |
| 1,500 psi                | <b>9310789</b> | 9456260        | 9734193        | <b>9318259</b> | 9207511        | 8985829        | 9314750         | <b>9314237</b>  | 9314490         | 9324143         |
| 2,000 psi                | <b>9310797</b> | 9455906        |                | <b>9318267</b> | 9456023        |                | 9314768         | <b>9314245</b>  | 9314504         | 9325026         |
| 3,000 psi                | <b>9310800</b> | 9455914        | 8985566        | <b>9318275</b> | <b>9435220</b> | 8985831        | 9314776         | <b>9314253</b>  | 9314512         | 9480609         |
| 5,000 psi                | <b>9310819</b> | 9456279        |                | <b>9318283</b> | <b>9442995</b> |                | 9314784         | <b>9314261</b>  | 9314520         | 9413448         |
| <b>List price</b>        | <b>\$82.15</b> | <b>\$82.15</b> | <b>\$82.15</b> | <b>\$85.25</b> | <b>\$85.25</b> | <b>\$85.25</b> | <b>\$225.10</b> | <b>\$225.10</b> | <b>\$239.35</b> | <b>\$239.35</b> |
| 7,500 psi                | <b>9325107</b> | 9455922        |                | 9318291        | <b>9128840</b> |                |                 |                 |                 |                 |
| <b>List price</b>        | <b>\$96.40</b> | <b>\$96.40</b> | <b>\$96.40</b> | <b>\$99.50</b> | <b>\$99.50</b> | <b>\$99.50</b> | <b>\$260.35</b> | <b>\$260.35</b> | <b>\$274.60</b> | <b>\$274.60</b> |
| 10,000 psi               | 9790454        |                |                |                |                |                | 9314792         | <b>9314270</b>  | 9314539         | 9413960         |
| 15,000 psi               |                |                |                |                |                |                |                 |                 |                 |                 |

<sup>1</sup> Vacuum scale: 30" Hg outside in black; 760 mm Hg inside in red.

Factory stocked items shown in **bold print**.  
Items without part numbers are available - consult factory.

# INDUSTRIAL GAUGES

Mechanical Pressure > Industrial Gauges > Options for 213.40

## Options for type 213.40

| Option   | Code                           | 213.40<br>2½" LM | 213.40<br>2½" CBM | 213.40<br>4" LM | 213.40<br>4" LBM |
|--|--------------------------------|------------------|-------------------|-----------------|------------------|
| <b>Case / ring options</b>                       |                                |                  |                   |                 |                  |
| Forged brass case, silver painted                | CS SILV                        | \$6.70           | \$6.70            | \$16.20         | \$16.20          |
| Forged brass case, black painted                 | CS BLK                         | n/a              | n/a               | n/a             | \$1.00           |
| Cover ring, polished brass                       | BR RNG                         | \$9.25           | \$9.25            | n/a             | n/a              |
| <b>Case/Ring Options</b>                         |                                |                  |                   |                 |                  |
| Glycerine / water (86.5 / 13.5)                  | GLY86.5                        | \$7.70           | \$7.70            | \$20.45         | \$20.45          |
| Silicone 1,000 cst                               | SIL1000                        | \$13.00          | \$13.00           | \$34.00         | \$34.00          |
| Silicone 50 cst                                  | SIL50                          | \$13.00          | \$13.00           | \$34.00         | \$34.00          |
| Silicone 350 cst                                 | SIL 350                        | \$13.00          | \$13.00           | \$34.00         | \$34.00          |
| <b>Connections</b>                               |                                |                  |                   |                 |                  |
| G1/8B  | G1/8                           | \$0.00           | \$0.00            | n/a             | n/a              |
| G1/4B  | G1/4                           | \$0.00           | \$0.00            | \$0.00          | \$0.00           |
| R1/4-ISO7  | R1/4                           | \$2.65           | \$2.65            | \$2.65          | \$2.65           |
| 7/16-20 SAE                                      | SAE                            | \$23.55          | \$23.55           | \$23.55         | \$23.55          |
| 3, 9 or 12 O'clock position                      | (3,9,12)CLK                    | \$9.15           | n/a               | \$9.15          | n/a              |
| Teflon® tape on connection                       | TT                             | \$0.70           | \$0.70            | \$0.70          | \$0.70           |
| <b>Mounting</b>                                  |                                |                  |                   |                 |                  |
| Front flange, SS polished                        | FF SS                          | \$39.20          | \$39.20           | n/a             | n/a              |
| Front flange, brass polished                     | FF BR                          | \$38.75          | \$38.75           | n/a             | n/a              |
| Front flange, chrome-plated steel                | FF CHR                         | \$30.70          | \$30.70           | n/a             | n/a              |
| Front flange, chrome-plated brass                | F CHR                          | n/a              | n/a               | \$80.45         | \$80.45          |
| Front flange, chrome-plated SS, no holes         | FF WO                          | \$39.20          | \$39.20           | \$80.45         | \$80.45          |
| Rear flange, black-painted steel                 | RF                             | \$23.65          | \$23.65           | n/a             | n/a              |
| Rear flange, chrome-plated brass                 | RF                             | n/a              | n/a               | \$38.70         | \$38.70          |
| U-clamp, chrome-plated steel ring, steel bracket | UC                             | n/a              | \$30.70           | n/a             | \$46.40          |
| <b>Windows</b>                                   |                                |                  |                   |                 |                  |
| Flat glass                                       | GLS                            | \$31.35          | \$31.35           | n/a             | n/a              |
| Safety glass                                     | SG                             | \$34.70          | \$34.70           | \$30.05         | \$30.05          |
| PMMA, with compensating membrane                 | COMP                           | \$7.15           | \$7.15            | \$9.80          | \$9.80           |
| <b>Pointers</b>                                  |                                |                  |                   |                 |                  |
| Drag pointer, red                                | DP                             | \$91.70          | \$91.70           | \$99.35         | \$99.35          |
| Mark pointer, red                                | MP                             | \$91.70          | \$91.70           | \$75.60         | \$75.60          |
| <b>Restrictors</b>                               |                                |                  |                   |                 |                  |
| Brass, press-fit, 0.3mm orifice                  | R                              | \$6.95           | \$6.95            | \$6.95          | \$6.95           |
| Brass, M3.5 thread, 0.5mm orifice                | R0.5                           | \$6.95           | \$6.95            | \$6.95          | \$6.95           |
| Sintered metal filter, brass                     | FLT                            | \$6.95           | \$6.95            | \$6.95          | \$6.95           |
| Sintered metal filter, SS                        | FLT SS                         | \$6.95           | \$6.95            | \$6.95          | \$6.95           |
| <b>Dials &amp; scales</b>                        |                                |                  |                   |                 |                  |
| Serial number on dial                            | SER#                           | \$5.55           | \$5.55            | \$5.55          | \$5.55           |
| <b>Other options available</b>                   |                                |                  |                   |                 |                  |
| Calibration and material certificates            | <i>Refer to pages 261, 262</i> |                  |                   |                 |                  |
| Special scales, logos and other artwork charges  | <i>Refer to pages 263, 265</i> |                  |                   |                 |                  |
| Needle valves, siphons and other accessories     | <i>Refer to pages 255-259</i>  |                  |                   |                 |                  |

Shaded options are non-standard and may require extended lead-times

# INDUSTRIAL GAUGES

Mechanical Pressure > Industrial Gauges > 21X.40PM

## Industrial Gauges - Forged Brass Case Paper Machine Gauges

### Standard features

- **Case:** Forged brass
- **Wetted parts:** Copper alloy
- **Window:** Acrylic
- **Window ring:** SS, crimped
- **Dial:** White aluminum
- **Pointer:** Black aluminum
- **Case fill:** None, fillable
- **Accuracy:**  $\pm 2/1/2\%$  of span
- **Polished SS front flange**
- **Datasheet:** 21X.40PM

| Type                           | 212.40PM   |
|--------------------------------|--|
| <b>Size</b>                    | <b>3 1/2"</b>  |
| <b>Connection</b>              | LBM/FF  |
| <b>Conn. size</b>              | 1/4" NPT   |
| <b>Press scale<sup>1</sup></b> | PSI  |
| <b>List price</b>              | <b>\$362.00</b>  |
| 30" Hg                         | 9838932  |
| 30"-0-15 psi                   |  |
| 30"-0-30 psi                   |  |
| 30"-0-60 psi                   |  |
| 30"-0-100 psi                  |  |
| 30"-0-160 psi                  |  |
| 30"-0-200 psi                  |  |
| <b>List price</b>              | <b>\$338.00</b>  |
| 15 psi                         |  |
| 30 psi                         | 8998804  |
| 60 psi                         | 8998812  |
| 100 psi                        | 8998820  |
| 160 psi                        | 9838940  |
| 200 psi                        | 8998838  |
| 300 psi                        | 8998846  |
| 400 psi                        | 8998855  |
| 600 psi                        | 8998863  |
| 800 psi                        |  |
| 1,000 psi                      | 8998871  |
| <b>List price</b>              | <b>\$413.00</b>  |
| 1,500 psi                      |  |
| 2,000 psi                      |  |
| 3,000 psi                      |  |
| 5,000 psi                      |  |

<sup>1</sup> Vacuum scale: 30" Hg outside in black; 760 mm Hg inside in red.

Factory stocked items shown in **bold print**.  
Items without part numbers are available - consult factory.



# INDUSTRIAL GAUGES

Mechanical Pressure > Industrial Gauges > Options for 21X.40PM

## Options for type 212.40PM

| Option  | Code                           | 212.40PM<br>3½" LBM/FF |
|---|--------------------------------|------------------------|
| <b>Case Liquid Fills</b>                        |                                |                        |
| Glycerine                                       | 213.40PM                       | <b>\$16.30</b>         |
| Glycerine / water (86.5 / 13.5)                 | GLY86.5                        | <b>\$20.45</b>         |
| Silicone 1,000 cst                              | SIL1000                        | <b>\$34.00</b>         |
| Silicone 50 cst                                 | SIL50                          | <b>\$34.00</b>         |
| Silicone 350 cst                                | SIL 350                        | <b>\$34.00</b>         |
| <b>Connections</b>                              |                                |                        |
| G1/4B or G1/2B                                  | G1/4 or G1/2                   | <b>\$0.00</b>          |
| Teflon® tape on connection                      | TT                             | <b>\$0.70</b>          |
| <b>Windows</b>                                  |                                |                        |
| Safety glass                                    | SG                             | <b>\$30.05</b>         |
| PMMA, with compensating membrane                | COMP                           | <b>\$9.80</b>          |
| <b>Restrictors</b>                              |                                |                        |
| Brass, press-fit, 0.3mm orifice                 | R                              | <b>\$6.95</b>          |
| Brass, M3.5 thread, 0.5mm orifice               | R0.5                           | <b>\$6.95</b>          |
| Sintered metal filter, brass                    | FLT                            | <b>\$7.00</b>          |
| Sintered metal filter, SS                       | FLT SS                         | <b>\$6.95</b>          |
| <b>Dials &amp; scales</b>                       |                                |                        |
| Serial number on dial                           | SER#                           | <b>\$5.55</b>          |
| <b>Other options available</b>                  |                                |                        |
| Calibration and material certificates           | <i>Refer to pages 261, 262</i> |                        |
| Special scales, logos and other artwork charges | <i>Refer to pages 263, 265</i> |                        |
| Needle valves, siphons and other accessories    | <i>Refer to pages 255-259</i>  |                        |

Shaded options are non-standard and may require extended lead-times

# INDUSTRIAL GAUGES

Mechanical Pressure > Industrial Gauges > 212.53





## Industrial Gauges - SS Case, Liquid-fillable

### Standard features

- **Case:** 304 SS
- **Wetted parts:** Copper alloy
- **Window:** Polycarbonate
- **Window ring:** SS, crimped
- **Dial:** White aluminum
- **Pointer:** Black aluminum
- **Case fill:** None, fillable
- **Accuracy:**  $\pm 2/1/2\%$  of span (2" & 2½" sizes)  
 $\pm 1\%$  of span (4" size)
- **Datasheet:** 21X.53



MECHANICAL PRESSURE

| Type                     | 212.53 (Dry)   |   |  |                |                        |  |                |                        |
|--------------------------|--|---|--|----------------|------------------------|--|----------------|------------------------|
| Size                     | 2"   |   | 2½"  |                |                        | 2½"  |                |                        |
| Connection               | LM  | CBM  | LM  |                |                        | CBM  |                |                        |
| Conn. size               | 1/4" NPT   |   | 1/4" NPT   |                |                        | 1/4" NPT   |                |                        |
| Press scale <sup>1</sup> | PSI/BAR  | PSI/BAR   | PSI  | PSI/BAR        | PSI/KG/CM <sup>2</sup> | PSI  | PSI/BAR        | PSI/KG/CM <sup>2</sup> |
| <b>List price</b>        | <b>\$28.40</b>   | <b>\$29.65</b>  | <b>\$28.40</b>   | <b>\$28.40</b> | <b>\$28.40</b>         | <b>\$29.65</b>   | <b>\$29.65</b> | <b>\$29.65</b>         |
| 30" Hg                   | 52019756   |   | 4269978  | 4270231        | 4270496                | 4270755  | 4271017        | 4271271                |
| 30"-0-15 psi             | 4311841  |   | 4269986  | 4311841        |                        | 4270763  |                |                        |
| 30"-0-30 psi             |  |   | 4269994  | 4270258        | 4270517                | 4270771  | 4271033        | 4271298                |
| 30"-0-60 psi             | 4311868  |   | 4270002  | 4270266        | 4270525                | 4270780  | 4271041        | 4271301                |
| 30"-0-100 psi            |  |   | 4270011  |                |                        | 4270798  |                |                        |
| 30"-0-160 psi            | 50082248   |   | 4270029  | 50082248       |                        | 4270801  |                |                        |
| 30"-0-200 psi            | 50987161   | 50082302  | 4270037  |                |                        | 4270810  |                |                        |
| <b>List price</b>        | <b>\$27.15</b>   | <b>\$28.40</b>  | <b>\$27.15</b>   | <b>\$27.15</b> | <b>\$27.15</b>         | <b>\$28.40</b>   | <b>\$28.40</b> | <b>\$28.40</b>         |
| 15 psi                   | 4311906  | 4315014   | 4270045  | 4270304        | 4270569                | 4270828  | 4271084        | 4271343                |
| 30 psi                   | 4311914  | 4315022   | 4270053  | 4270312        | 4270577                | 4270836  | 4271092        | 4271351                |
| 60 psi                   | 4311922  | 4315031   | 4270061  | 4270321        | 4270585                | 4270844  | 4271106        | 4271361                |
| 100 psi                  | 4311931  | 4315049   | 4270070  | 4270339        | 4270593                | 4270852  | 4271114        | 4271379                |
| 160 psi                  | 4311949  | 4315057   | 4270088  | 4270347        | 4270606                | 4270861  | 4271122        | 4271387                |
| 200 psi                  | 4311957  | 4315065   | 4270096  | 4270355        | 4270614                | 4270879  | 4271131        | 4271395                |
| 300 psi                  | 4311965  | 4315073   | 4270100  | 4270363        | 4270622                | 4270887  | 4271149        | 4271408                |
| 400 psi                  | 4311973  |   | 4270118  | 4270371        | 4270631                | 4270895  | 4271157        | 4271416                |
| 600 psi                  | 4311981  | 4315090   | 4270126  | 4270381        | 4270640                | 4270909  | 4271165        | 4271424                |
| 800 psi                  |  |   |  |                |                        |  |                |                        |
| 1,000 psi                | 4312007  | 4315111   | 4270142  | 4270401        | 4270666                | 4270925  | 4271181        | 4271441                |
| <b>List price</b>        | <b>\$30.40</b>   | <b>\$31.65</b>  | <b>\$30.40</b>   | <b>\$30.40</b> | <b>\$30.40</b>         | <b>\$31.65</b>   | <b>\$31.65</b> | <b>\$31.65</b>         |
| 1,500 psi                | 4312015  | 4315120   | 4270151  | 4270410        | 4270674                | 4270933  | 4271191        | 4271450                |
| 2,000 psi                | 4312023  | 4315138   | 4270169  | 4270428        | 4270682                | 4270941  | 4271203        | 4271468                |
| 3,000 psi                | 4312031  | 4315146   | 4270177  | 4270436        | 4270691                | 4270950  | 4271211        | 4271476                |
| 5,000 psi                | 4312040  | 4315154   | 4270185  | 4270444        | 4270703                | 4270968  | 4271220        | 4271484                |
| 6,000 psi                |  |   | 4270193  | 4270452        | 50273493               |  | 4271238        |                        |
| 7,500 psi                | 4312058  | 4315162   |  | 4270461        |                        | 4270984  | 4271246        |                        |
| <b>List price</b>        | <b>\$39.60</b>   | <b>\$40.85</b>  | <b>\$39.60</b>   | <b>\$39.60</b> | <b>\$39.60</b>         | <b>\$40.85</b>   | <b>\$40.85</b> | <b>\$40.85</b>         |
| 10,000 psi               | 4312066  | 4315171   | 4270215  | 4270470        | 4270739                | 4270992  | 4271254        | 4271513                |
| 15,000 psi               |  |   | 50228820   | 50310267       | 50771191               |  |                |                        |

<sup>1</sup> Vacuum scale: 30" Hg outside in black; 760 mm Hg inside in red.

Factory stocked items shown in **bold print**. Items without part numbers are available - consult factory.

Reference page 46 for 212.53 options.

# INDUSTRIAL GAUGES

Mechanical Pressure > Industrial Gauges > 213.53



| Type                     | 213.53 (Liquid-filled) |                |                |                |                |
|--------------------------|------------------------|----------------|----------------|----------------|----------------|
| Size                     | 2½"                    |                |                |                |                |
| Connection               | LM ●                   |                | LM ●           | CBM ⊕          |                |
| Conn. size               | ¼" NPT                 |                | 7/16"-20 SAE   | ¼" NPT         |                |
| Press scale <sup>1</sup> | PSI                    | PSI/BAR        | PSI/BAR        | PSI            | PSI/BAR        |
| <b>List price</b>        | <b>\$30.40</b>         | <b>\$30.40</b> | <b>\$38.70</b> | <b>\$31.65</b> | <b>\$31.65</b> |
| 30" Hg                   | <b>9767002</b>         | 9691957        |                | <b>9767185</b> | 9692139        |
| 30"-0-15 psi             |                        |                |                | 50158945       |                |
| 30"-0-30 psi             | <b>9767010</b>         | 9691965        |                |                | 50343459       |
| 30"-0-60 psi             | 9767029                | 9691974        |                | 50251091       | 4264600        |
| 30"-0-100 psi            |                        |                |                | 9797097        |                |
| 30"-0-160 psi            |                        |                |                | 50144928       |                |
| 30"-0-200 psi            |                        |                |                | 50343211       |                |
| <b>List price</b>        | <b>\$29.15</b>         | <b>\$29.15</b> | <b>\$37.45</b> | <b>\$30.40</b> | <b>\$30.40</b> |
| 15 psi                   | <b>9767037</b>         | 9691982        |                | 9797314        |                |
| 30 psi                   | <b>9767045</b>         | <b>9691990</b> |                | <b>9767193</b> | 9692147        |
| 60 psi                   | <b>9767053</b>         | <b>9692007</b> | 52017141       | <b>9767202</b> | 9692155        |
| 100 psi                  | <b>9767061</b>         | <b>9692015</b> | 9795664        | <b>9767215</b> | <b>9692164</b> |
| 160 psi                  | <b>9767070</b>         | <b>9692024</b> | 9795672        | <b>9767223</b> | 9692172        |
| 200 psi                  | <b>9767088</b>         | 9692032        | 9795680        | <b>9767231</b> | 9692180        |
| 300 psi                  | <b>9767096</b>         | <b>9692040</b> | 4259916        | <b>9767240</b> | 9692198        |
| 400 psi                  | <b>9767100</b>         | 9692058        | 50083571       | 8999109        | 4244461        |
| 600 psi                  | <b>9767118</b>         | <b>9692066</b> | 50244515       | <b>9768947</b> | 9692202        |
| 800 psi                  |                        |                |                |                |                |
| 1,000 psi                | <b>9767126</b>         | <b>9692075</b> |                | <b>9767258</b> | 9692210        |
| <b>List price</b>        | <b>\$32.40</b>         | <b>\$32.40</b> | <b>\$40.70</b> | <b>\$33.65</b> | <b>\$33.65</b> |
| 1,500 psi                | <b>9767134</b>         | <b>9692083</b> | 50244531       | 9768165        | 9692228        |
| 2,000 psi                | <b>9767142</b>         | <b>9692091</b> | 9795698        | 9768939        | 9692236        |
| 3,000 psi                | <b>9767150</b>         | <b>9692105</b> | 9795702        | <b>9767266</b> | 9692245        |
| 5,000 psi                | <b>9767169</b>         | <b>9692113</b> | 9795710        | <b>9767274</b> | 9692253        |
| 6,000 psi                |                        | <b>9748207</b> | 9795728        |                |                |
| <b>List price</b>        | <b>\$41.60</b>         | <b>\$41.60</b> | <b>\$49.90</b> | <b>\$42.85</b> | <b>\$42.65</b> |
| 10,000 psi               | <b>9767177</b>         | 9692121        | 4225384        | 9767282        | 9692261        |
| 15,000 psi               |                        |                |                |                |                |



<sup>1</sup> Vacuum scale: 30" Hg outside in black; 760 mm Hg inside in red.

Factory stocked items shown in **bold print**. Items without part numbers are available - consult factory.

Reference page 46 for 213.53 options.

# INDUSTRIAL GAUGES

Mechanical Pressure > Industrial Gauges > 212.53, 213.53

| Type                     | 212.53 (Dry)   |                | 213.53 (Liquid-filled)   |                |   |                 |
|--------------------------|--|----------------|--|----------------|---|-----------------|
| Size                     | 4"   |                |  |                |   |                 |
| Connection               | LM  |                | LM  |                | LBM  |                 |
| Conn. size               | ¼" NPT   | ½" NPT         | ¼" NPT   | ½" NPT         |   | ½" NPT          |
| Press scale <sup>1</sup> | PSI  | PSI            | PSI  | PSI            | PSI/BAR   | PSI/BAR         |
| List price               | <b>\$63.80</b>   | <b>\$63.80</b> | <b>\$71.55</b>   | <b>\$71.55</b> | <b>\$71.55</b>  | <b>\$78.20</b>  |
| 30" Hg                   | 4271531  | 50778471       | <b>9699028</b>   |                | 9734427   | 9734533         |
| 30"-0-15 psi             | 4271549  | 52156737       | 9699036  | 50085964       | 4215471   |                 |
| 30"-0-30 psi             | 4271557  | 50225928       | <b>9699045</b>   | 50984510       | 50416235  | 4230194         |
| 30"-0-60 psi             | 4271565  | 50816004       | <b>9699053</b>   | 4363987        | 4255471   |                 |
| 30"-0-100 psi            | 4271573  | 50543555       | 9699061  | 50044923       | 50694332  |                 |
| 30"-0-160 psi            | 4271581  | 50788027       | <b>9699079</b>   | 50487124       | 50924494  | 50534947        |
| 30"-0-200 psi            | 4271590  |                | 9699087  |                |   |                 |
| List price               | <b>\$61.55</b>   | <b>\$61.55</b> | <b>\$69.30</b>   | <b>\$69.30</b> | <b>\$69.30</b>  | <b>\$75.95</b>  |
| 15 psi                   | 4271602  |                | <b>9699095</b>   | 50032241       | 9734320   | 9734435         |
| 30 psi                   | 4271611  | 50402137       | <b>9699109</b>   | 50989023       | 9734338   | 9734444         |
| 60 psi                   | <b>4271620</b>   | 50561430       | <b>9699117</b>   | 50989031       | 9734346   | 9734452         |
| 100 psi                  | 4271638  | 50372190       | <b>9699125</b>   | 50983637       | <b>9734355</b>  | 9734460         |
| 160 psi                  | 4271646  | 4272145        | <b>9699257</b>   | 50989155       | <b>9734363</b>  | 9734478         |
| 200 psi                  | 4271654  | 4272153        | <b>9699134</b>   | 4276770        | 50987110  | 50670085        |
| 300 psi                  | <b>4271662</b>   | 4272161        | <b>9699142</b>   | 50069608       | <b>9734371</b>  | 9734486         |
| 400 psi                  | 4271671  | 50821920       | 9699150  | 50050869       | 50823493  | 50541781        |
| 600 psi                  | 4271689  | 4272189        | <b>9699168</b>   | 4388696        | <b>9734389</b>  | 9734495         |
| 800 psi                  |  |                | 9699176  | 50070240       |   |                 |
| 1,000 psi                | 4271701  | <b>4272200</b> | <b>9699185</b>   | <b>4228732</b> | <b>9734397</b>  | 9734508         |
| List price               | <b>\$66.15</b>   | <b>\$66.15</b> | <b>\$73.90</b>   | <b>\$73.90</b> | <b>\$73.90</b>  | <b>\$80.55</b>  |
| 1,500 psi                | 4271719  | 4272218        | 9699193  | <b>9766885</b> | 9734401   | 9734516         |
| 2,000 psi                | 4271727  | 4272226        | 9699206  | <b>9766876</b> | 4201591   |                 |
| 3,000 psi                | 4271735  | 4272234        | <b>9699215</b>   | <b>9766893</b> | 9734419   | 9734525         |
| 5,000 psi                | 4271743  | <b>4272242</b> | <b>9699223</b>   | <b>9766906</b> | 4201604   |                 |
| 6,000 psi                |  |                |  |                |   | 50175211        |
| List price               | <b>\$91.80</b>   | <b>\$91.80</b> | <b>\$99.55</b>   | <b>\$99.55</b> | <b>\$99.55</b>  | <b>\$106.20</b> |
| 10,000 psi               | 4271760  | 4272260        | 9699231  | <b>9766915</b> | 52160122  | 50896598        |
| 15,000 psi               | 4271778  | 50463993       | 9699249  | 50476734       | 52256642  | 52005887        |

<sup>1</sup>Vacuum scale: 30" Hg outside in black; 760 mm Hg inside in red.

Factory stocked items shown in **bold print**.  
Items without part numbers are available - consult factory.

# INDUSTRIAL GAUGES

Mechanical Pressure > Industrial Gauges > Options for 212.53, 213.53

## Options for type 21X.53

| Option  | Code                           | 21X.53<br>2" LM | 21X.53<br>2" CBM | 21X.53<br>2½" LM | 21X.53<br>2½" CBM | 21X.53<br>4" LM | 21X.53<br>4" LBM |
|---|--------------------------------|-----------------|------------------|------------------|-------------------|-----------------|------------------|
| <b>Case Liquid Fills</b>                        |                                |                 |                  |                  |                   |                 |                  |
| Glycerine                                       | 213.53                         | \$2.00          | \$2.00           | \$2.00           | \$2.00            | \$7.75          | \$7.75           |
| Glycerine / water (86.5 / 13.5)                 | GLY86.5                        | \$6.35          | \$6.35           | \$6.35           | \$6.35            | \$24.60         | \$24.60          |
| Silicone 1,000 cst                              | SIL1000                        | \$13.15         | \$13.15          | \$13.15          | \$13.15           | \$34.40         | \$34.40          |
| Silicone 50 cst                                 | SIL50                          | \$13.15         | \$13.15          | \$13.15          | \$13.15           | \$34.40         | \$34.40          |
| Silicone 350 cst                                | SIL 350                        | \$13.15         | \$13.15          | \$13.15          | \$13.15           | \$34.40         | \$34.40          |
| <b>Connections</b>                              |                                |                 |                  |                  |                   |                 |                  |
| 1/8" NPT or G1/8B                               | 1/8 or G1/8                    | \$0.00          | \$0.00           | \$0.00           | \$0.00            | n/a             | n/a              |
| G1/4B   | G1/4                           | \$0.00          | \$0.00           | \$0.00           | \$0.00            | \$0.00          | \$0.00           |
| G1/2B   | G1/2                           | n/a             | n/a              | n/a              | n/a               | \$0.00          | \$0.00           |
| 7/16-20 SAE                                     | SAE                            | \$8.30          | \$8.30           | \$8.30           | \$8.30            | \$23.80         | \$23.80          |
| R1/4-2999                                       | R1/4                           | \$6.95          | \$6.95           | \$6.95           | \$6.95            | \$10.65         | \$10.65          |
| 3, 9 or 12 O'clock position                     | (3,9,12)CLK                    | \$9.25          | n/a              | \$9.25           | n/a               | \$9.25          | n/a              |
| Nickel-plated connection                        | NKL SKT                        | \$4.35          | \$4.35           | \$4.35           | \$4.35            | \$4.35          | \$7.20           |
| 10-32 internal tap                              | 10-32                          | \$1.90          | \$1.90           | \$1.90           | \$1.90            | \$1.90          | \$1.90           |
| Teflon® tape on connection                      | TT                             | \$0.70          | \$0.70           | \$0.70           | \$0.70            | \$0.70          | \$0.70           |
| <b>Mounting</b>                                 |                                |                 |                  |                  |                   |                 |                  |
| Front flange, SS polished                       | FF                             | n/a             | \$11.85          | n/a              | \$11.85           | n/a             | \$27.15          |
| Front flange, SS polished, no holes             | FF WO                          | n/a             | n/a              | n/a              | \$11.85           | n/a             | \$27.15          |
| Rear flange, SS                                 | RF                             | n/a             | n/a              | \$12.00          | \$12.00           | \$23.75         | \$23.75          |
| U-clamp, steel bracket                          | UC ST                          | n/a             | \$7.40           | n/a              | \$7.40            | n/a             | \$27.25          |
| U-clamp, SS bracket                             | UC SS                          | n/a             | n/a              | n/a              | \$13.70           | n/a             | \$31.60          |
| <b>Windows</b>                                  |                                |                 |                  |                  |                   |                 |                  |
| Acrylic with compensating membrane              | COMP                           | n/a             | n/a              | \$7.20           | \$7.20            | \$15.25         | \$15.25          |
| Safety glass                                    | SG                             | \$34.20         | \$34.20          | \$34.20          | \$34.20           | n/a             | n/a              |
| <b>Pointers</b>                                 |                                |                 |                  |                  |                   |                 |                  |
| Drag pointer, red                               | DP                             | n/a             | n/a              | \$38.05          | \$38.05           | \$100.05        | \$100.05         |
| Mark pointer, red                               | MP                             | n/a             | n/a              | \$38.05          | \$38.05           | \$100.05        | \$100.05         |
| <b>Restrictors</b>                              |                                |                 |                  |                  |                   |                 |                  |
| Brass, press-fit, 0.3mm orifice                 | R                              | \$2.50          | \$2.50           | \$2.50           | \$2.50            | \$4.00          | \$4.00           |
| SS, M4 thread, 0.6mm orifice                    | R0.5                           | \$5.00          | \$5.00           | \$5.00           | \$5.00            | \$5.90          | \$5.90           |
| Sintered metal filter, brass                    | FLT                            | \$5.90          | \$5.90           | \$5.90           | \$5.90            | \$6.20          | \$6.20           |
| Sintered metal filter, SS                       | FLT SS                         | \$5.90          | \$5.90           | \$5.90           | \$5.90            | \$6.20          | \$6.20           |
| <b>Dials &amp; scales</b>                       |                                |                 |                  |                  |                   |                 |                  |
| Dial, aluminum white                            | DIAL AL                        | \$0.25          | \$0.25           | \$0.25           | \$0.25            | n/a             | n/a              |
| Dial, luminescent                               | LUM                            | n/a             | n/a              | \$4.75           | \$4.75            | n/a             | n/a              |
| Receiver scales (3-15 PSI)                      | REC                            | n/a             | n/a              | \$17.55          | \$17.55           | \$21.50         | \$21.50          |
| <b>Movements</b>                                |                                |                 |                  |                  |                   |                 |                  |
| External zero adjustment screw on window        | EXT ADJ                        | n/a             | n/a              | \$16.75          | \$16.75           | \$22.20         | \$22.20          |
| <b>Other options available</b>                  |                                |                 |                  |                  |                   |                 |                  |
| Calibration and material certificates           | <i>Refer to pages 261, 262</i> |                 |                  |                  |                   |                 |                  |
| Special scales, logos and other artwork charges | <i>Refer to pages 263, 265</i> |                 |                  |                  |                   |                 |                  |
| Needle valves, siphons and other accessories    | <i>Refer to pages 255-259</i>  |                 |                  |                  |                   |                 |                  |

Shaded options are non-standard and may require extended lead-times



# INDUSTRIAL GAUGES

Mechanical Pressure > Industrial Gauges > 232.53

## Industrial Gauges - SS Gauges, Liquid-fillable

### Standard features

- **Case:** 304 SS
- **Wetted parts:** 316L SS
- **Window:** Polycarbonate
- **Window ring:** SS, crimped
- **Dial:** White aluminum
- **Pointer:** Black aluminum
- **Case fill:** None, fillable
- **Accuracy:**  $\pm 2/1/2\%$  of span (2" & 2½" sizes)  
 $\pm 1\%$  of span (4" size)
- **Datasheet:** 23X.53



| Type                     | 232.53 (Dry)   |                 |                |                 |                 |                 |
|--------------------------|----------------|-----------------|----------------|-----------------|-----------------|-----------------|
| Size                     | 2"             |                 |                | 2½"             |                 |                 |
| Connection               | LM             | CBM             | LM             | CBM             |                 |                 |
| Conn. size               | ¼" NPT         |                 |                | ¼" NPT          |                 |                 |
| Press scale <sup>1</sup> | PSI            | PSI             | PSI            | PSI             | PSI/BAR         | PSI/KPA         |
| <b>List price</b>        | <b>\$68.15</b> | <b>\$77.15</b>  | <b>\$68.15</b> | <b>\$77.15</b>  | <b>\$77.15</b>  | <b>\$77.15</b>  |
| 30" Hg                   | 50533614       | 50533797        | <b>9768777</b> | 9768394         |                 |                 |
| 30"-0-15 psi             | 50533622       | 50533801        |                |                 |                 |                 |
| 30"-0-30 psi             | 50533631       | 50533819        | <b>9768769</b> | 9768386         |                 |                 |
| 30"-0-60 psi             | 50533649       | 50533827        | 9768750        | 9768378         |                 |                 |
| 30"-0-100 psi            | 50533657       | 50533835        |                |                 |                 |                 |
| 30"-0-160 psi            | 50533665       | 50533843        | 9768742        | 9768360         |                 |                 |
| 30"-0-200 psi            | 50533673       | 50533851        |                |                 |                 |                 |
| <b>List price</b>        | <b>\$64.80</b> | <b>\$73.80</b>  | <b>\$64.80</b> | <b>\$73.80</b>  | <b>\$73.80</b>  | <b>\$73.80</b>  |
| 15 psi                   | 50533690       | 50533860        | <b>9768734</b> | 9768351         |                 |                 |
| 30 psi                   | 4222680        | 50533878        | <b>9768726</b> | 9768343         |                 |                 |
| 60 psi                   | 4282907        | 4214318         | <b>9768718</b> | <b>9768335</b>  | 8992848         | 8993089         |
| 100 psi                  | 4222698        | 4282915         | <b>9768700</b> | <b>9768327</b>  | 8992856         | 8993097         |
| 160 psi                  | 50466721       | 50466747        | <b>9768696</b> | <b>9768319</b>  | 8992865         | 8993101         |
| 200 psi                  | 4282923        | 50533886        | <b>9768688</b> | 9768300         | 8992873         | 8993119         |
| 300 psi                  | 50533711       | 50533894        | <b>9768670</b> | 9768297         | 8992881         | 8993127         |
| 400 psi                  | 50533720       | 50533908        | 9768661        | 9768289         |                 |                 |
| 600 psi                  | 4222702        | 50533916        | <b>9768653</b> | 9768270         | 9779685         | 9779693         |
| 800 psi                  |                |                 |                |                 |                 |                 |
| 1,000 psi                | 4222710        | 50533932        | <b>9768645</b> | 9768262         | 8992899         | 8993135         |
| <b>List price</b>        | <b>\$71.60</b> | <b>\$80.60</b>  | <b>\$71.60</b> | <b>\$80.60</b>  | <b>\$80.60</b>  | <b>\$80.60</b>  |
| 1,500 psi                | 50533746       | 50533941        | 9768637        | 9768254         | 8992903         | 8993144         |
| 2,000 psi                | 50533754       | 50533959        | 9768629        | 9768246         | 8992911         | 8993152         |
| 3,000 psi                | 50466739       | 50466755        | <b>9768610</b> | 9768238         | 8992929         | 8993160         |
| 5,000 psi                | 50533762       | 50533967        | <b>9768602</b> | 9768220         | 8992937         | 8993178         |
| 6,000 psi                |                |                 |                | 8993208         | 8992945         | 8993186         |
| 10,000 psi               | 50533771       | 50533975        | 9768599        | 9768211         | 8992954         | 8993195         |
| <b>List price</b>        | <b>\$94.85</b> | <b>\$103.85</b> | <b>\$94.85</b> | <b>\$103.85</b> | <b>\$103.85</b> | <b>\$103.85</b> |
| 15,000 psi               | 50533789       | 50533983        |                | 9779715         | 9776715         | 9779723         |

Factory stocked items shown in **bold print**.  
Items without part numbers are available - consult factory.

Reference page 50 for **232.53** options.

# INDUSTRIAL GAUGES

Mechanical Pressure > Industrial Gauges > 232.53

| Type                     | 232.53 (Dry)   |   |                 |
|--------------------------|--|---|-----------------|
| Size                     | 4"   |   |                 |
| Connection               | LM  | LBM  |                 |
| Conn. size               | ¼" NPT   | ½" NPT  | ½" NPT          |
| Press scale <sup>1</sup> | PSI  | PSI   | PSI             |
| <b>List price</b>        | <b>\$129.50</b>  | <b>\$129.50</b>   | <b>\$142.60</b> |
| 30" Hg                   | 9767576  | 9768459   | 9737057         |
| 30"-0-15 psi             | 9737910  | 9768467   | 9737065         |
| 30"-0-30 psi             | 9767398  | 9768475   | 9737073         |
| 30"-0-60 psi             | 9767401  | 9768483   | 9737081         |
| 30"-0-100 psi            | 9737898  | 9737880   | 9737090         |
| 30"-0-160 psi            | 9767410  | 9768491   | 9737103         |
| 30"-0-200 psi            | 9737901  | 9768505   | 9737111         |
| <b>List price</b>        | <b>\$124.85</b>  | <b>\$124.85</b>   | <b>\$137.95</b> |
| 15 psi                   | 9767428  | 9768513   | 9737120         |
| 30 psi                   | 9767436  | 9768521   | 9737138         |
| 60 psi                   | 9767444  | 9768530   | 9737146         |
| 100 psi                  | <b>9767452</b>   | 9768548   | 9737154         |
| 160 psi                  | 9767460  | 9768556   | 9737162         |
| 200 psi                  | 9767479  | 9768564   | 9737170         |
| 300 psi                  | <b>9767487</b>   | <b>9768572</b>  | 9737189         |
| 400 psi                  | 9767495  | 9768580   | 9737197         |
| 600 psi                  | 9767509  | 9768963   | 9737200         |
| 800 psi                  |  |   | 9737219         |
| 1,000 psi                | 9767517  | 9768858   | 9737227         |
| <b>List price</b>        | <b>\$130.35</b>  | <b>\$130.35</b>   | <b>\$143.45</b> |
| 1,500 psi                |  | 9768866   | 9737235         |
| 2,000 psi                |  | 9768807   | 9737243         |
| 3,000 psi                |  | 9768874   | 9737251         |
| 5,000 psi                |  | 9768823   | 9737260         |
| 6,000 psi                |  |   |                 |
| 10,000 psi               |  | 9768831   | 9737278         |
| <b>List price</b>        | <b>\$166.55</b>  | <b>\$166.55</b>   | <b>\$179.65</b> |
| 15,000 psi               |  | 9768840   | 9737286         |





Factory stocked items shown in **bold print**.  
Items without part numbers are available - consult factory.

Reference page 50 for 232.53 options.

# INDUSTRIAL GAUGES

Mechanical Pressure > Industrial Gauges > 233.53, 232.53 Ammonia

MECHANICAL PRESSURE

| Type                     | 233.53 (Glycerine filled)  |   |  |   |                 |
|--------------------------|--|---|--|---|-----------------|
| Size                     | 2 1/2"   |   | 4"   |   |                 |
| Connection               | LM  | CBM  | LM  | LBM  |                 |
| Conn. size               | 1/4" NPT   |   | 1/4" NPT   | 1/2" NPT  |                 |
| Press scale <sup>1</sup> | PSI  | PSI   | PSI  | PSI   | PSI             |
| <b>List price</b>        | <b>\$72.75</b>   | <b>\$81.75</b>  | <b>\$145.95</b>  | <b>\$145.95</b>   | <b>\$159.05</b> |
| 30" Hg                   | 9833646  | 9833310   | 9833124  | 9833328   | 9831504         |
| 30"-0-15 psi             |  |   | 9831775  | 9833336   | 9831512         |
| 30"-0-30 psi             | <b>9833638</b>   | 9833302   | 9832993  | 9833345   | 9831520         |
| 30"-0-60 psi             | 9833620  | 9833298   | 9833000  | 9833353   | 9831538         |
| 30"-0-100 psi            |  |   | 9831759  | 9831741   | 9831546         |
| 30"-0-160 psi            | 9833612  | 9833280   | 9833018  | 9833361   | 9831555         |
| 30"-0-200 psi            |  |   | 9831767  | 9833379   | 9831563         |
| <b>List price</b>        | <b>\$69.40</b>   | <b>\$78.40</b>  | <b>\$141.30</b>  | <b>\$141.30</b>   | <b>\$154.40</b> |
| 15 psi                   | <b>9833604</b>   | 9833272   | 9833026  | 9833387   | 9831571         |
| 30 psi                   | <b>9833590</b>   | 9833264   | 9833035  | 9833395   | 9831589         |
| 60 psi                   | <b>9833582</b>   | <b>9833255</b>  | 9833043  | 9833409   | 9831597         |
| 100 psi                  | <b>9833574</b>   | <b>9833247</b>  | 9833051  | <b>9833417</b>  | 9831601         |
| 160 psi                  | <b>9833565</b>   | 9833239   | 9833069  | 9833425   | 9831619         |
| 200 psi                  | <b>9833557</b>   | <b>9833221</b>  | 9833077  | <b>9833434</b>  | 9831627         |
| 300 psi                  | <b>9833549</b>   | <b>9833213</b>  | <b>9833085</b>   | <b>9833442</b>  | 9831635         |
| 400 psi                  | <b>9833531</b>   | 9833205   | 9833094  | 9833450   | 9831644         |
| 600 psi                  | <b>9833523</b>   | 9833191   | 9833107  | 9833727   | 9831652         |
| 800 psi                  |  |   |  |   |                 |
| 1,000 psi                | <b>9833515</b>   | 9833183   | 9833115  | 9833697   | 9831678         |
| <b>List price</b>        | <b>\$76.20</b>   | <b>\$85.20</b>  | <b>\$146.80</b>  | <b>\$146.80</b>   | <b>\$159.90</b> |
| 1,500 psi                | 9833506  | 9833175   |  | <b>9833701</b>  | 9831686         |
| 2,000 psi                | <b>9833493</b>   | 9833166   |  | <b>9833655</b>  | 9831695         |
| 3,000 psi                | <b>9833485</b>   | 9833158   |  | <b>9833719</b>  | 9831708         |
| 5,000 psi                | <b>9833476</b>   | 9833140   |  | <b>9833663</b>  | 9831716         |
| 10,000 psi               | 9833468  | 9833132   |  | 9833671   | 9831725         |
| <b>List price</b>        | <b>\$99.45</b>   | <b>\$108.45</b>   | <b>\$183.00</b>  | <b>\$183.00</b>   | <b>\$196.10</b> |
| 15,000 psi               |  |   |  | 9833689   | 9831733         |

| Type                     | 232.53   |                 |
|--------------------------|--|-----------------|
| Category                 | Ammonia Gauges   |                 |
| Connection               | LM  |                 |
| Size                     | 2 1/2"   | 4"              |
| Conn. size               | 1/4" NPT   |                 |
| Press scale <sup>1</sup> | PSI/°F   | PSI/°F          |
| <b>List price</b>        | <b>\$68.10</b>   | <b>\$132.35</b> |
| 30"-0-150 psi / 84°F     | 9797144  | 9797127         |
| 30"-0-300 psi / 126°F    | 9797152  | 9797135         |

<sup>1</sup>Vacuum scale: 30" Hg outside in black; 760 mm Hg inside in red.

Factory stocked items shown in **bold print**.  
Items without part numbers are available - consult factory.

# INDUSTRIAL GAUGES

Mechanical Pressure > Industrial Gauges > Options for 23X.53

## Options for type 23X.53

| Option   | Code                           | 23X.53  | 23X.53  | 23X.53  | 23X.53  | 23X.53   | 23X.53   |
|--|--------------------------------|---------|---------|---------|---------|----------|----------|
|  |                                | 2" LM   | 2" CBM  | 2½" LM  | 2½" CBM | 4" LM    | 4" LBM   |
| <b>Case liquid fills</b>   |                                |         |         |         |         |          |          |
| Glycerine  | 213.53                         | \$4.60  | \$4.60  | \$4.60  | \$4.60  | \$16.45  | \$16.45  |
| Glycerine / water (86.5 / 13.5)  | GLY86.5                        | \$7.80  | \$7.80  | \$7.80  | \$7.80  | \$20.70  | \$20.70  |
| Silicone 1,000 cst   | SIL1000                        | \$13.15 | \$13.15 | \$13.15 | \$13.15 | \$34.40  | \$34.40  |
| Silicone 50 cst  | SIL50                          | \$13.15 | \$13.15 | \$13.15 | \$13.15 | \$34.40  | \$34.40  |
| Silicone 350 cst   | SIL 350                        | \$13.15 | \$13.15 | \$13.15 | \$13.15 | \$34.40  | \$34.40  |
| <b>Connections</b>   |                                |         |         |         |         |          |          |
| 1/8" NPT or G1/8B  | 1/8 or G1/8                    | \$0.00  | \$0.00  | \$0.00  | \$0.00  | n/a      | n/a      |
| G1/4B  | G1/4                           | \$0.00  | \$0.00  | \$0.00  | \$0.00  | \$0.00   | \$0.00   |
| G1/2B  | G1/2                           | n/a     | n/a     | n/a     | n/a     | \$0.00   | \$0.00   |
| 7/16-20 SAE  | SAE                            | \$23.80 | \$23.80 | \$23.80 | \$23.80 | \$23.80  | \$23.80  |
| R1/4-2999  | R1/4                           | \$9.25  | \$9.25  | \$9.25  | \$9.25  | n/a      | n/a      |
| 3, 9 or 12 O'clock position  | (3,9,12)CLK                    | \$9.25  | n/a     | \$9.25  | n/a     | \$9.25   | n/a      |
| 10-32 internal tap   | 10-32                          | \$1.90  | \$1.90  | \$1.90  | \$1.90  | \$1.90   | \$1.90   |
| Teflon® tape on connection   | TT                             | \$0.70  | \$0.70  | \$0.70  | \$0.70  | \$0.70   | \$0.70   |
| <b>Mounting</b>  |                                |         |         |         |         |          |          |
| Front flange, SS polished  | FF                             | n/a     | \$18.85 | n/a     | \$18.85 | n/a      | \$27.15  |
| Front flange, SS polished, without holes   | FF WO                          | n/a     | n/a     | n/a     | \$18.85 | n/a      | \$27.15  |
| Front flange, SS polished for 4½" panel mount  | FF4.5                          | n/a     | n/a     | n/a     | n/a     | n/a      | \$32.35  |
| Rear flange, SS  | RF                             | n/a     | n/a     | \$19.10 | \$19.10 | \$23.75  | \$23.75  |
| U-clamp, steel bracket   | UC ST                          | n/a     | \$11.85 | n/a     | \$11.85 | n/a      | \$27.25  |
| U-clamp, SS bracket  | UC SS                          | n/a     | n/a     | n/a     | \$21.90 | n/a      | \$31.60  |
| <b>Windows</b>   |                                |         |         |         |         |          |          |
| Acrylic with compensating membrane   | COMP                           | n/a     | n/a     | \$14.85 | \$14.85 | \$15.25  | \$15.25  |
| Safety glass   | SG                             | \$16.60 | \$16.60 | \$16.60 | \$16.60 | \$30.40  | \$30.40  |
| <b>Pointers</b>  |                                |         |         |         |         |          |          |
| Drag pointer, red  | DP                             | n/a     | n/a     | \$38.05 | \$38.05 | \$100.05 | \$100.05 |
| Mark pointer, red  | MP                             | n/a     | n/a     | \$38.05 | \$38.05 | \$100.05 | \$100.05 |
| <b>Restrictors</b>   |                                |         |         |         |         |          |          |
| SS, M4 thread, 0.6mm orifice   | R                              | \$7.00  | \$7.00  | \$7.00  | \$7.00  | \$7.00   | \$7.00   |
| SS, M4 thread, 0.3mm orifice   | R0.3                           | \$8.10  | \$8.10  | \$8.10  | \$8.10  | \$8.10   | \$8.10   |
| <b>Dials &amp; scales</b>  |                                |         |         |         |         |          |          |
| Serial number on dial  | SER#                           | \$5.65  | \$5.65  | \$5.65  | \$5.65  | \$5.65   | \$5.65   |
| Receiver scales (3-15 PSI)   | REC                            | n/a     | n/a     | \$17.55 | \$17.55 | \$21.50  | \$21.50  |
| <b>Movements</b>   |                                |         |         |         |         |          |          |
| Dampened movement  | DAMP                           | n/a     | n/a     | \$15.00 | \$15.00 | \$15.00  | \$15.00  |
| External zero adjustment screw on window   | EXT ADJ                        | n/a     | n/a     | n/a     | n/a     | \$22.20  | \$22.20  |
| <b>Other</b>   |                                |         |         |         |         |          |          |
| Clean for O2 service (ASME Level IV)   | O2                             | \$20.60 | \$20.60 | \$20.60 | \$20.60 | \$20.60  | \$20.60  |
| NACE compliance, MR0175 latest edition.<br>For 316L SS wetted parts; includes *NACE SOUR<br>GAS SERVICE* printed on dial | NACE                           | \$24.00 | \$24.00 | \$24.00 | \$24.00 | \$24.00  | \$24.00  |
| <b>Other options available</b>   |                                |         |         |         |         |          |          |
| Calibration and material certificates  | <i>Refer to pages 261, 262</i> |         |         |         |         |          |          |
| Special scales, logos and other artwork charges  | <i>Refer to pages 263, 265</i> |         |         |         |         |          |          |
| Needle valves, siphons and other accessories   | <i>Refer to pages 255-259</i>  |         |         |         |         |          |          |

Shaded options are non-standard and may require extended lead-times

For datasheets and additional information, please visit [www.wika.com](http://www.wika.com) or call 1-888-945-2872.

# INDUSTRIAL GAUGES

Mechanical Pressure > Industrial Gauges > 232.54, 233.54





## Industrial Gauges - SS Case and Bayonet Ring

### Standard features

- **Case:** 304 SS
- **Wetted parts:** 316L SS
- **Window:** Safety glass
- **Window ring:** SS, bayonet
- **Dial:** White aluminum
- **Pointer:** Black aluminum, adjustable
- **Case fill:** None, fillable
- **Accuracy:**  $\pm 2\frac{1}{2}\%$  of span (2½" sizes)  
 $\pm 1\%$  of span (4" size)
- **Datasheet:** 23X.54



MECHANICAL PRESSURE

| Type                     | 232.54 (Dry)   |                 |   |                 | 233.54 (Filled)  |   |
|--------------------------|--|-----------------|---|-----------------|--|---|
| Size                     | 2½"  |                 |   |                 |  |   |
| Connection               | LM  |                 | CBM  |                 | LM  | CBM  |
| Conn. size               | ¼" NPT   |                 |   |                 | ¼" NPT   |   |
| Press scale <sup>1</sup> | PSI  | PSI/BAR         | PSI   | PSI/BAR         | PSI  | PSI   |
| <b>List price</b>        | <b>\$85.65</b>   | <b>\$85.65</b>  | <b>\$94.65</b>  | <b>\$94.65</b>  | <b>\$90.25</b>   | <b>\$99.25</b>  |
| 30" Hg                   | 9744827  | 9735245         | 9745068   | 9735385         | 9831784  | 9832020   |
| 30"-0-15 psi             | 9744835  | 50547194        | 9745076   | 9745076         | 9831792  | 9832046   |
| 30"-0-30 psi             | 9744843  | 50092391        | 9745084   | 9745084         | 9831805  | 9832055   |
| 30"-0-60 psi             | 9744851  | 50422481        | 9745092   | 9745092         | 9831814  | 9832063   |
| 30"-0-100 psi            | 9744860  |                 | 9745106   | 9745106         | 9831822  | 9832071   |
| 30"-0-160 psi            | 9744878  | 50462989        | 9745114   | 9745114         | 9831830  | 9832089   |
| 30"-0-200 psi            | 9744886  |                 | 9745122   | 9745122         | 9831848  | 9832097   |
| <b>List price</b>        | <b>\$82.30</b>   | <b>\$82.30</b>  | <b>\$91.30</b>  | <b>\$91.30</b>  | <b>\$86.90</b>   | <b>\$95.90</b>  |
| 15 psi                   | 9744894  | 9735114         | 9745130   | 9735254         | 9831856  | 9832101   |
| 30 psi                   | <b>9744908</b>   | 9735122         | 9745149   | 9735262         | <b>9831865</b>   | 9832119   |
| 60 psi                   | <b>9744916</b>   | 9735130         | 9745157   | 9735270         | <b>9831873</b>   | 9832127   |
| 100 psi                  | <b>9744924</b>   | 9735148         | 9745165   | 9735288         | <b>9831881</b>   | 9832135   |
| 160 psi                  | <b>9744932</b>   | 9735156         | 9745173   | 9735296         | <b>9831899</b>   | 9832144   |
| 200 psi                  | <b>9744940</b>   | 9837642         | 9745181   | 4310489         | <b>9831903</b>   | 9832152   |
| 300 psi                  | <b>9744959</b>   | 9735165         | 9745190   | 9735300         | <b>9831911</b>   | 9832160   |
| 400 psi                  | 9744967  |                 | 9745203   | 50092481        | 9831929  | 9832178   |
| 600 psi                  | <b>9744975</b>   | 9735173         | 9745211   | 9735318         | <b>9831937</b>   | 9832186   |
| 800 psi                  | 9744983  |                 | 9745220   |                 | 9831945  | 9832195   |
| 1,000 psi                | 9744991  | 9735181         | 9745238   | 9735326         | 9831954  | 9832208   |
| <b>List price</b>        | <b>\$89.10</b>   | <b>\$89.10</b>  | <b>\$98.10</b>  | <b>\$98.10</b>  | <b>\$93.70</b>   | <b>\$102.70</b>   |
| 1,500 psi                | 9745009  | 9735199         | 9745246   | 9735335         | <b>9831962</b>   | 9832216   |
| 2,000 psi                | 9745017  |                 | 9745254   | 50507176        | <b>9831970</b>   | <b>9832225</b>  |
| 3,000 psi                | 9745025  | 9735203         | 9745262   | 9735343         | <b>9831988</b>   | 9832233   |
| 5,000 psi                | 9745033  | 9735211         | 9745270   | 9735351         | 9831996  | <b>9832241</b>  |
| 10,000 psi               | 9745041  | 9735229         | 9745289   | 9735369         | 9832004  | 9832259   |
| <b>List price</b>        | <b>\$112.35</b>  | <b>\$112.35</b> | <b>\$121.35</b>   | <b>\$121.35</b> | <b>\$116.95</b>  | <b>\$125.95</b>   |
| 15,000 psi               | 9745050  | 9735237         | 9694760   | 9745297         | 9832012  | 9832267   |





<sup>1</sup>Vacuum scale: 30" Hg outside in black; 760 mm Hg inside in red.

Factory stocked items shown in **bold print**. Items without part numbers are available - consult factory.

Reference page 54 for 23X.54 options.

# INDUSTRIAL GAUGES

Mechanical Pressure > Industrial Gauges > 232.54, 233.54

| Type                     | 232.54 (Dry)   |                 |   | 233.54 (Filled)  |                 |   |
|--------------------------|--|-----------------|---|--|-----------------|---|
| Size                     | <b>4"</b>  |                 |   |  |                 |   |
| Connection               | LM  |                 | LBM  | LM  |                 | LBM  |
| Conn. size               | ¼" NPT   | ½" NPT          | ½" NPT  | ¼" NPT   | ½" NPT          |   |
| Press scale <sup>1</sup> | PSI  | PSI             | PSI   | PSI  | PSI             | PSI   |
| <b>List price</b>        | <b>\$144.80</b>  | <b>\$144.80</b> | <b>\$157.90</b>   | <b>\$161.25</b>  | <b>\$161.25</b> | <b>\$174.35</b>   |
| 30" Hg                   | 9745300  | 9745548         | 9745785   | 9832275  | 9832518         | 9832755   |
| 30"-0-15 psi             | 9745319  | 9745556         | 9745793   | 9832284  | 9832526         | 9832764   |
| 30"-0-30 psi             | 9745327  | 9745564         | 9745807   | 9832292  | 9832535         | 9832772   |
| 30"-0-60 psi             | 9745335  | 9745572         | 9745815   | 9832305  | 9832543         | 9832780   |
| 30"-0-100 psi            | 9745343  | 9745580         | 9745823   | 9832314  | 9832551         | 9832798   |
| 30"-0-160 psi            | 9745351  | 9745599         | 9745831   | 9832322  | 9832569         | 9832802   |
| 30"-0-200 psi            | 9745360  | 9745602         | 9745840   | 9832330  | 9832577         | 9832810   |
| <b>List price</b>        | <b>\$140.15</b>  | <b>\$140.15</b> | <b>\$153.25</b>   | <b>\$156.60</b>  | <b>\$156.60</b> | <b>\$169.70</b>   |
| 15 psi                   | 9745378  | 9745610         | 9745858   | 9832348  | 9832585         | 9832828   |
| 30 psi                   | 9745386  | 9745629         | 9745866   | 9832356  | 9832594         | 9832836   |
| 60 psi                   | <b>9745394</b>   | 9745637         | 9745874   | 9832365  | <b>9832607</b>  | 9832845   |
| 100 psi                  | <b>9745408</b>   | <b>9745645</b>  | 9745882   | 9832373  | <b>9832615</b>  | 9832853   |
| 160 psi                  | 9745416  | 9745653         | 9745890   | 9832381  | <b>9832624</b>  | 9832861   |
| 200 psi                  | <b>9745424</b>   | <b>9745661</b>  | 9745904   | 9832399  | <b>9832632</b>  | 9832879   |
| 300 psi                  | 9745432  | <b>9745670</b>  | 9745912   | 9832403  | <b>9832640</b>  | 9832887   |
| 400 psi                  | 9745440  | <b>9745688</b>  | 9745920   | 9832411  | <b>9832658</b>  | 9832895   |
| 600 psi                  | 9745459  | <b>9745696</b>  | 9745939   | 9832429  | <b>9832666</b>  | 9832909   |
| 800 psi                  | 9745467  | 9745700         | 9745947   | 9832437  | 9832675         | 9832917   |
| 1,000 psi                | 9745475  | <b>9745718</b>  | 9745955   | 9832445  | <b>9832683</b>  | 9832925   |
| <b>List price</b>        | <b>\$145.65</b>  | <b>\$145.65</b> | <b>\$158.75</b>   | <b>\$162.10</b>  | <b>\$162.10</b> | <b>\$175.20</b>   |
| 1,500 psi                | 9745483  | <b>9745726</b>  | 9745963   | 9832454  | <b>9832691</b>  | 9832934   |
| 2,000 psi                | 9745491  | <b>9745734</b>  | 9745971   | 9832462  | <b>9832705</b>  | 9832942   |
| 3,000 psi                | 9745505  | <b>9745742</b>  | 9745980   | 9832470  | <b>9832713</b>  | 9832950   |
| 5,000 psi                | 9745513  | <b>9745750</b>  | 9745998   | 9832488  | <b>9832721</b>  | 9832968   |
| 10,000 psi               | 9745521  | 9745769         | 9746005   | 9832496  | <b>9832739</b>  | 9832976   |
| <b>List price</b>        | <b>\$181.85</b>  | <b>\$181.85</b> | <b>\$194.95</b>   | <b>\$198.30</b>  | <b>\$198.30</b> | <b>\$211.40</b>   |
| 15,000 psi               | 9745530  | 9745777         | 9746013   | 9832500  | 9832747         | 9832985   |

<sup>1</sup>Vacuum scale: 30" Hg outside in black; 760 mm Hg inside in red.

Factory stocked items shown in **bold print**.  
Items without part numbers are available - consult factory.





Reference page 54 for **23X.54** options.

# INDUSTRIAL GAUGES

Mechanical Pressure > Industrial Gauges > 232.54 XMAS, 233.54 Receiver

| Type                     | 232.54 XMAS  |
|--------------------------|--|
| Category                 | XMAS tree gauges   |
| Connection               | LM  |
| Size                     | 4"   |
| Conn. size               | 1/2" NPT   |
| Press scale <sup>1</sup> | PSI  |
| List price               | \$140.20   |
| 1,000 psi                | 8992350  |
| List price               | \$145.60   |
| 1,500 psi                | 8992342  |
| 2,000 psi                | <b>8992334</b>   |
| 3,000 psi                | <b>8992325</b>   |
| 5,000 psi                | <b>8992317</b>   |
| 10,000 psi               | 8992309  |



| Type       | 232.54 Receiver  |   |  |   |
|------------|--|---|--|---|
| Category   | Receiver Gauges  |   |  |   |
| Connection | LM  | CBM  | LM  | LBM  |
| Size       | 2 1/2"   |   | 4"   |   |
| Conn. size | 1/4" NPT   |   | 1/2" NPT   |   |
| List price | \$99.85  | \$104.95  | \$161.65   | \$174.75  |
| 100%       | 9749470  | 9749497   | 9749500  | 9749519   |
| 10 sq. rt. | 9749462  | 9749489   |  |   |

<sup>1</sup>Vacuum scale: 30" Hg outside in black; 760 mm Hg inside in red.

Factory stocked items shown in **bold print**.  
Items without part numbers are available - consult factory.

# INDUSTRIAL GAUGES

Mechanical Pressure > Industrial Gauges > Options for 23X.54

## Options for type 23X.54

| Option   | Code                    | 23X.54<br>2½" LM | 23X.54<br>2½" CBM | 23X.54<br>4" LM | 23X.54<br>4" LBM |
|--|-------------------------|------------------|-------------------|-----------------|------------------|
| <b>Case liquid fills</b>   |                         |                  |                   |                 |                  |
| Glycerine  | 213.53                  | \$4.60           | \$4.60            | \$16.45         | \$16.45          |
| Glycerine / water (86.5 / 13.5)  | GLY86.5                 | \$7.80           | \$7.80            | \$20.70         | \$20.70          |
| Silicone 1000 cst  | SIL1000                 | \$13.15          | \$13.15           | \$34.40         | \$34.40          |
| Silicone 50 cst  | SIL50                   | \$13.15          | \$13.15           | \$34.40         | \$34.40          |
| Silicone 350 cst   | SIL 350                 | \$13.15          | \$13.15           | \$34.40         | \$34.40          |
| <b>Connections</b>   |                         |                  |                   |                 |                  |
| 1/8" NPT or G1/8B  | 1/8 or G1/8             | \$0.00           | \$0.00            | n/a             | n/a              |
| G1/4B  | G1/4                    | \$0.00           | \$0.00            | \$0.00          | \$0.00           |
| G1/2B  | G1/2                    | n/a              | n/a               | \$0.00          | \$0.00           |
| 7/16-20 SAE  | SAE                     | \$23.80          | \$23.80           | \$23.80         | \$23.80          |
| R1/4-2999  | R1/4                    | \$9.25           | \$9.25            | n/a             | n/a              |
| 3, 9 or 12 O'clock position  | (3,9,12)CLK             | \$9.25           | n/a               | \$9.25          | n/a              |
| 10-32 internal tap   | 10-32                   | \$1.90           | \$1.90            | \$1.90          | \$1.90           |
| Teflon® tape on connection   | TT                      | \$0.70           | \$0.70            | \$0.70          | \$0.70           |
| <b>Mounting</b>  |                         |                  |                   |                 |                  |
| Front flange, SS polished  | FF                      | n/a              | \$19.55           | n/a             | \$27.15          |
| Front flange, SS polished, without holes   | FF WO                   | n/a              | \$18.85           | n/a             | \$27.15          |
| Front flange, SS polished for 4½" panel mount  | FF4.5                   | n/a              | n/a               | n/a             | \$32.35          |
| Rear flange, SS  | RF                      | \$19.10          | \$19.10           | \$23.75         | \$23.75          |
| U-clamp, steel bracket   | UC ST                   | n/a              | \$23.35           | n/a             | \$27.25          |
| U-clamp, SS bracket  | UC ST                   | n/a              | \$33.70           | n/a             | \$31.60          |
| <b>Windows</b>   |                         |                  |                   |                 |                  |
| Polycarbonate  | PC                      | \$0.00           | \$0.00            | \$0.00          | \$0.00           |
| <b>Pointers</b>  |                         |                  |                   |                 |                  |
| Drag pointer, red  | DP                      | \$38.05          | \$38.05           | \$100.05        | \$100.05         |
| Mark pointer, red  | MP                      | \$38.05          | \$38.05           | \$100.05        | \$100.05         |
| <b>Restrictors</b>   |                         |                  |                   |                 |                  |
| SS, M4 thread, 0.6mm orifice   | R                       | \$7.00           | \$7.00            | \$7.00          | \$7.00           |
| SS, M4 thread, 0.3mm orifice   | R0.3                    | \$8.10           | \$8.10            | \$8.10          | \$8.10           |
| <b>Dials &amp; scales</b>  |                         |                  |                   |                 |                  |
| Serial number on dial  | SER#                    | \$5.65           | \$5.65            | \$5.65          | \$5.65           |
| Receiver scales (3-15 PSI)   | REC                     | \$17.55          | \$17.55           | \$21.50         | \$21.50          |
| <b>Movements</b>   |                         |                  |                   |                 |                  |
| Dampened movement  | DAMP                    | \$15.00          | \$15.00           | \$15.00         | \$15.00          |
| <b>Other</b>   |                         |                  |                   |                 |                  |
| Clean for O2 service (ASME Level IV)   | O2                      | \$20.60          | \$20.60           | \$20.60         | \$20.60          |
| Accuracy 1.0%  | 1%                      | \$6.80           | \$6.80            | std.            | std.             |
| NACE compliance, MR0175 latest edition.<br>For 316L SS wetted parts; includes *NACE SOUR<br>GAS SERVICE* printed on dial | NACE                    | \$24.00          | \$24.00           | \$24.00         | \$24.00          |
| <b>Other options available</b>   |                         |                  |                   |                 |                  |
| Calibration and material certificates  | Refer to pages 261, 262 |                  |                   |                 |                  |
| Special scales, logos and other artwork charges  | Refer to pages 263, 265 |                  |                   |                 |                  |
| Needle valves, siphons and other accessories   | Refer to pages 255-259  |                  |                   |                 |                  |

Shaded options are non-standard and may require extended lead-times

For datasheets and additional information, please visit [www.wika.com](http://www.wika.com) or call 1-888-945-2872.



# INDUSTRIAL GAUGES

Mechanical Pressure > Industrial Gauges > 233.55

## Industrial Gauges - SS Panel Gauges

### Standard features

- **Case:** 304 SS
- **Wetted parts:** 316L SS
- **Window:** Safety glass
- **Window ring:** SS, crimped
- **Dial:** White aluminum
- **Pointer:** Black aluminum
- **Case fill:** Glycerine
- **Accuracy:**  $\pm 2/1/2\%$  of span (2 1/2" sizes)
- **Polished SS front flange**
- **SS restrictor**
- **Datasheet:** 233.55

| Type                     | 233.55   |                 |
|--------------------------|--|-----------------|
| Size                     | 2 1/2"   |                 |
| Connection               | LBM/FF  |                 |
| Conn. size               | 1/4" NPT   |                 |
| Press scale <sup>1</sup> | PSI  | PSI/BAR         |
| <b>List price</b>        | <b>\$86.80</b>   | <b>\$86.80</b>  |
| 30" Hg                   | 4282811  | 4283078         |
| 30"-0-15 psi             | 4282829  | 4283086         |
| 30"-0-30 psi             | 4282837  | 4283094         |
| 30"-0-60 psi             | 4282845  | 4283107         |
| 30"-0-100 psi            | 4282854  | 4283115         |
| 30"-0-160 psi            | 4282862  | 4283124         |
| 30"-0-200 psi            | 4282870  | 4283133         |
| <b>List price</b>        | <b>\$83.45</b>   | <b>\$83.45</b>  |
| 15 psi                   | 4282888  | 4283141         |
| 30 psi                   | 4282896  | 4283159         |
| 60 psi                   | 4282900  | 4283167         |
| 100 psi                  | 4282918  | 4283175         |
| 160 psi                  | 4282926  | 4283184         |
| 200 psi                  | 4282934  | 4283192         |
| 300 psi                  | 4282943  | 4283204         |
| 400 psi                  | 4282951  | 4283214         |
| 600 psi                  | 4282969  | 4283222         |
| 800 psi                  | 4282977  | 4283230         |
| 1,000 psi                | 4282985  | 4283248         |
| <b>List price</b>        | <b>\$90.25</b>   | <b>\$90.25</b>  |
| 1,500 psi                | 4282994  | 4283256         |
| 2,000 psi                | 4283000  | 4283264         |
| 3,000 psi                | 4283018  | 4283273         |
| 5,000 psi                | 4283026  | 4283281         |
| 6,000 psi                | 4283034  | 4283299         |
| <b>List price</b>        | <b>\$113.50</b>  | <b>\$113.50</b> |
| 10,000 psi               | 4283044  | 4283303         |
| 15,000 psi               | 4283052  | 4283311         |
| 20,000 psi               | 4283060  | 4283329         |



<sup>1</sup>Vacuum scale: 30" Hg outside in black; 760 mm Hg inside in red.

Factory stocked items shown in **bold print**.

Items without part numbers are available - consult factory.

# INDUSTRIAL GAUGES

Mechanical Pressure > Industrial Gauges > Options for 233.55

## Options for type 233.55

| Option   | Code                           | 233.55<br>2½" CBM |
|--|--------------------------------|-------------------|
| <b>Case liquid fills</b>   |                                |                   |
| Glycerine  |                                | <b>STD</b>        |
| Glycerine / water (86.5 / 13.5)  | GLY86.5                        | <b>\$7.80</b>     |
| Silicone 1,000 cst   | SIL1000                        | <b>\$13.15</b>    |
| Silicone 50 cst  | SIL50                          | <b>\$13.15</b>    |
| Silicone 350 cst   | SIL 350                        | <b>\$13.15</b>    |
| <b>Connections</b>   |                                |                   |
| G1/8B or G1/4B   | G1/8 or G1/4                   | <b>\$0.00</b>     |
| R1/4-2999  | R1/4                           | <b>\$9.25</b>     |
| 10-32 internal tap   | 10-32                          | <b>\$1.90</b>     |
| Teflon® tape on connection   | TT                             | <b>\$0.70</b>     |
| <b>Windows</b>   |                                |                   |
| Polycarbonate  | PC                             | <b>\$0.00</b>     |
| <b>Restrictors</b>   |                                |                   |
| SS, M4 thread, 0.6mm orifice   | R                              | <b>STD</b>        |
| SS, M4 thread, 0.3mm orifice   | R0.3                           | <b>\$8.10</b>     |
| <b>Dials &amp; scales</b>  |                                |                   |
| Serial number on dial  | SER#                           | <b>\$5.65</b>     |
| <b>Other</b>   |                                |                   |
| Clean for O2 service (ASME Level IV)<br>**available only with dry case**   | O2                             | <b>\$20.60</b>    |
| NACE compliance, MR0175 latest edition.<br>For 316L SS wetted parts; includes *NACE SOUR<br>GAS SERVICE* printed on dial | NACE                           | <b>\$24.00</b>    |
| <b>Other options available</b>   |                                |                   |
| Calibration and material certificates  | <i>Refer to pages 261, 262</i> |                   |
| Special scales, logos and other artwork charges  | <i>Refer to pages 263, 265</i> |                   |
| Needle valves, siphons and other accessories   | <i>Refer to pages 255-259</i>  |                   |

Shaded options are non-standard and may require extended lead-times



# INDUSTRIAL GAUGES

Mechanical Pressure > Industrial Gauges > 232.30

## Industrial Gauges - Solid-front Safety Case

### Standard features

- **Case:** 304 SS, solid-front
- **Wetted parts:** 316L SS
- **Window:** 2½" - polycarbonate  
4", 4½" and 6" - safety glass
- **Window ring:** SS, bayonet
- **Dial:** White aluminum
- **Pointer:** Black aluminum, adjustable
- **Case fill:** None, fillable
- **Accuracy:** ±2/1/2% of span (2½" size)  
±1% of span (4", 4½" and 6"size)
- **Datasheet:** 23X.30

| Type                     | 232.30 (Dry)   |   |
|--------------------------|--|---|
| Size                     | 2½"  |   |
| Connection               | LM  | LBM  |
| Conn. size               | ¼" NPT   |   |
| Press scale <sup>1</sup> | PSI  | PSI   |
| <b>List price</b>        | <b>\$116.55</b>  | <b>\$123.60</b>   |
| 30" Hg                   | 9305645  | 9367071   |
| 30"-0-15 psi             | 9365044  | 9365079   |
| 30"-0-30 psi             | 9314822  | 9481486   |
| 30"-0-60 psi             | 9305378  | 9197141   |
| 30"-0-100 psi            | 9542353  | 9319646   |
| 30"-0-160 psi            | 9365052  | 9469168   |
| 30"-0-200 psi            | 9367250  |   |
| <b>List price</b>        | <b>\$109.50</b>  | <b>\$116.55</b>   |
| 15 psi                   | 9305653  | 9244808   |
| 30 psi                   | 9240160  | 9244816   |
| 60 psi                   | 9240179  | 9244832   |
| 100 psi                  | 9240187  | 9244840   |
| 160 psi                  | 9240195  | 9244859   |
| 200 psi                  | 9240209  | 9244867   |
| 300 psi                  | 9240217  | 9244875   |
| 400 psi                  | 9240225  | 9244883   |
| 600 psi                  | 9240233  | 9244905   |
| 800 psi                  |  |   |
| 1,000 psi                | 9240411  | 9244913   |
| <b>List price</b>        | <b>\$124.75</b>  | <b>\$131.80</b>   |
| 1,500 psi                | 9240420  | 9244921   |
| 2,000 psi                | 9240438  | 9244930   |
| 3,000 psi                | 9240446  | 9244948   |
| 5,000 psi                | 9240454  | 9244956   |
| 10,000 psi               | 9305661  | 9244964   |
| <b>List price</b>        | <b>\$154.10</b>  | <b>\$161.15</b>   |
| 15,000 psi               | 9482644  | 9153810   |





<sup>1</sup>Vacuum scale: 30" Hg outside in black; 760 mm Hg inside in red.

Factory stocked items shown in **bold print**.  
Items without part numbers are available - consult factory.

Reference page 60 for **232.30** options.

# INDUSTRIAL GAUGES

Mechanical Pressure > Industrial Gauges > 232.30

| Type                     | 232.30 (Dry)   |   |  |                 |
|--------------------------|--|---|--|-----------------|
| Size                     | 4"   |   | 4½"  |                 |
| Connection               | LM  | LBM  | LM  |                 |
| Conn. size               | ½" NPT   |   | ½" NPT   |                 |
| Press scale <sup>1</sup> | PSI  | PSI   | PSI  | PSI/BAR         |
| <b>List price</b>        | <b>\$184.00</b>  | <b>\$207.15</b>   | <b>\$207.85</b>  | <b>\$207.85</b> |
| 30" Hg                   | 9366750  | 8596271   | 50756966   |                 |
| 30"-0-15 psi             |  |   | 50759674   |                 |
| 30"-0-30 psi             | 9366776  | 9562559   | 50756991   |                 |
| 30"-0-60 psi             |  |   | 50757008   |                 |
| 30"-0-100 psi            |  |   | 50757016   |                 |
| 30"-0-160 psi            |  |   | 50757024   |                 |
| 30"-0-200 psi            |  |   | 50757032   |                 |
| <b>List price</b>        | <b>\$181.20</b>  | <b>\$204.35</b>   | <b>\$204.60</b>  | <b>\$204.60</b> |
| 15 psi                   | 9366830  | 9253289   | 50757041   | 50757342        |
| 30 psi                   | 9366849  | 9253270   | 50757059   | 50757351        |
| 60 psi                   | 9366857  | 8596298   | 50757067   | 50757377        |
| 100 psi                  | 9366865  | 9253084   | 50757075   | 50757393        |
| 160 psi                  | 9366873  | 8596301   | 50757083   | 50757415        |
| 200 psi                  | 9366881  | 9253076   | 50757091   | 50757440        |
| 300 psi                  | 9366890  | 9821082   | 50757105   | 50757474        |
| 400 psi                  | 9366903  | 8542805   | 50757148   | 50757482        |
| 600 psi                  | 9366911  | 9253050   | 50757156   | 50757491        |
| 800 psi                  |  |   | 50757172   | 50757512        |
| 1,000 psi                | 9366938  | 8513554   | 50757202   | 50757521        |
| <b>List price</b>        | <b>\$197.75</b>  | <b>\$220.90</b>   | <b>\$221.75</b>  | <b>\$221.75</b> |
| 1,500 psi                | 9366946  | 8541574   | 50757229   | 50757547        |
| 2,000 psi                | 9366954  |   | 50757253   | 50757555        |
| 3,000 psi                | 9366962  |   | 50757261   | 50757580        |
| 5,000 psi                | 9366970  |   | 50757270   | 50757610        |
| 10,000 psi               | 9366989  |   | 50757296   | 50757628        |
| <b>List price</b>        | <b>\$235.90</b>  | <b>\$259.05</b>   | <b>\$260.30</b>  | <b>\$260.30</b> |
| 15,000 psi               | 9366997  |   | 50757318   | 50757644        |
| 20,000 psi               | 8596336  |   |  |                 |

<sup>1</sup>Vacuum scale: 30" Hg outside in black; 760 mm Hg inside in red.

Factory stocked items shown in **bold print**. Items without part numbers are available - consult factory.

Reference page 60 for 232.30 options.

# INDUSTRIAL GAUGES

Mechanical Pressure > Industrial Gauges > 233.30

| Type                     | 233.30 (Filled)  |                 |
|--------------------------|--|-----------------|
| Size                     | 2½"  | 4"              |
| Connection               | LM  |                 |
| Conn. size               | ¼" NPT   | ½" NPT          |
| Press scale <sup>1</sup> | PSI  | PSI             |
| <b>List price</b>        | <b>\$121.20</b>  | <b>\$200.50</b> |
| 30" Hg                   | 9305637  |                 |
| 30"-0-15 psi             | 9366580  |                 |
| 30"-0-30 psi             | 9364994  |                 |
| 30"-0-60 psi             | 9366598  |                 |
| 30"-0-100 psi            | 9367853  |                 |
| 30"-0-160 psi            | 9319638  |                 |
| 30"-0-200 psi            | 9637141  |                 |
| <b>List price</b>        | <b>\$114.15</b>  | <b>\$197.70</b> |
| 15 psi                   | 9305394  | 9361081         |
| 30 psi                   | 9251618  | 9361090         |
| 60 psi                   | <b>9251626</b>   | 9361103         |
| 100 psi                  | <b>9251634</b>   | <b>9361111</b>  |
| 160 psi                  | 9251642  | 9361120         |
| 200 psi                  | <b>9251650</b>   | 9361138         |
| 300 psi                  | 9251669  | 9361146         |
| 400 psi                  | 9251677  | 9361154         |
| 600 psi                  | <b>9251685</b>   | <b>9361162</b>  |
| 800 psi                  | 9251693  | 9361170         |
| 1,000 psi                | <b>9251707</b>   | <b>9361189</b>  |
| <b>List price</b>        | <b>\$129.40</b>  | <b>\$214.25</b> |
| 1,500 psi                | 9251715  | 9361197         |
| 2,000 psi                | 9251723  | <b>9361200</b>  |
| 3,000 psi                | 9251731  | <b>9361219</b>  |
| 5,000 psi                | 9251740  | <b>9361227</b>  |
| 10,000 psi               | 9305629  | 9361235         |
| <b>List price</b>        | <b>\$158.75</b>  | <b>\$252.40</b> |
| 15,000 psi               | 9542345  | 9361243         |
| 20,000 psi               | N/A  | 9829601         |

<sup>1</sup>Vacuum scale: 30" Hg outside in black; 760 mm Hg inside in red.

Factory stocked items shown in **bold print**. Items without part numbers are available - consult factory.

# INDUSTRIAL GAUGES

Mechanical Pressure > Industrial Gauges > Options for 233.30

## Options for type 233.30

| Option   | Code                           | 23X.30<br>2½" LM | 23X.30<br>2½" LBM | 23X.30<br>4" LM | 23X.30<br>4" LBM | 23X.30<br>4½" LM |
|--|--------------------------------|------------------|-------------------|-----------------|------------------|------------------|
| <b>Case liquid fills</b>   |                                |                  |                   |                 |                  |                  |
| Glycerine  | 233.30                         | \$4.65           | n/a               | \$16.50         | n/a              | \$19.70          |
| Glycerine / water (86.5 / 13.5)  | GLY86.5                        | \$7.80           | n/a               | \$20.70         | n/a              | \$24.65          |
| Silicone 1,000 cst   | SIL1000                        | \$13.15          | n/a               | \$34.40         | n/a              | \$41.05          |
| Silicone 50 cst  | SIL50                          | \$13.15          | n/a               | \$34.40         | n/a              | \$41.05          |
| Silicone 350 cst   | SIL 350                        | \$13.15          | n/a               | \$34.40         | n/a              | \$41.05          |
| <b>Connections</b>   |                                |                  |                   |                 |                  |                  |
| 1/8" NPT or G1/8B  | 1/8 or G1/8                    | \$0.00           | \$0.00            | n/a             | n/a              | n/a              |
| G1/4B  | G1/4                           | \$0.00           | \$0.00            | \$0.00          | \$0.00           | \$0.00           |
| G1/2B  | G1/2                           | n/a              | n/a               | \$0.00          | \$0.00           | \$0.00           |
| 7/16-20 SAE  | SAE                            | \$23.80          | \$23.80           | \$23.80         | \$23.80          | n/a              |
| R1/4-2999  | R1/4                           | \$9.25           | \$9.25            | n/a             | n/a              | n/a              |
| 3, 9 or 12 O'clock position  | (3,9,12)CLK                    | \$9.25           | n/a               | \$9.25          | n/a              | \$9.25           |
| 10-32 internal tap   | 10-32                          | \$1.90           | \$1.90            | \$1.90          | \$1.90           | \$1.90           |
| Teflon® tape on connection   | TT                             | \$0.70           | \$0.70            | \$0.70          | \$0.70           | \$0.70           |
| <b>Mounting</b>  |                                |                  |                   |                 |                  |                  |
| Front flange, SS polished  | FF                             | n/a              | \$55.90           | n/a             | \$55.90          | \$63.85          |
| <b>Windows</b>   |                                |                  |                   |                 |                  |                  |
| Polycarbonate  | PC                             | Standard         | Standard          | \$0.00          | \$0.00           | \$0.00           |
| <b>Pointers</b>  |                                |                  |                   |                 |                  |                  |
| Drag pointer, red  | DP                             | \$38.05          | \$38.05           | \$100.05        | \$100.05         | \$100.05         |
| Mark pointer, red  | MP                             | \$38.05          | \$38.05           | \$100.05        | \$100.05         | \$100.05         |
| <b>Restrictors</b>   |                                |                  |                   |                 |                  |                  |
| SS, M4 thread, 0.6mm orifice   | R                              | \$7.00           | \$7.00            | \$7.00          | \$7.00           | \$7.00           |
| SS, M4 thread, 0.3mm orifice   | R0.3                           | \$8.10           | \$8.10            | \$8.10          | \$8.10           | \$8.10           |
| <b>Dials &amp; scales</b>  |                                |                  |                   |                 |                  |                  |
| Serial number on dial  | SER#                           | \$5.65           | \$5.65            | \$5.65          | \$5.65           | \$5.65           |
| Receiver scales (3-15 PSI)   | REC                            | \$17.55          | \$17.55           | \$21.50         | \$21.50          | \$5.65           |
| <b>Movements</b>   |                                |                  |                   |                 |                  |                  |
| Dampened movement  | DAMP                           | \$15.00          | \$15.00           | \$15.00         | \$15.00          | \$15.00          |
| <b>Other</b>   |                                |                  |                   |                 |                  |                  |
| Clean for O2 service (ASME Level IV)   | O2                             | \$20.60          | \$20.60           | \$20.60         | \$20.60          | \$20.60          |
| NACE compliance, MR0175 latest edition.<br>For 316L SS wetted parts; includes *NACE SOUR<br>GAS SERVICE* printed on dial | NACE                           | \$24.00          | \$24.00           | \$24.00         | \$24.00          | \$24.00          |
| <b>Other options available</b>   |                                |                  |                   |                 |                  |                  |
| Calibration and material certificates  | <i>Refer to pages 261, 262</i> |                  |                   |                 |                  |                  |
| Special scales, logos and other artwork charges  | <i>Refer to pages 263, 265</i> |                  |                   |                 |                  |                  |
| Needle valves, siphons and other accessories   | <i>Refer to pages 255-259</i>  |                  |                   |                 |                  |                  |

Shaded options are non-standard and may require extended lead-times



# INDUSTRIAL GAUGES

Mechanical Pressure > Industrial Gauges > 232.50

## Industrial Gauges - SS Case and Wetted Parts

### Standard features

- **Case:** 304 SS
- **Wetted parts:** 316L SS
- **Window:** 2½" - polycarbonate  
4", 4½" and 6" - safety glass
- **Window ring:** SS, bayonet
- **Dial:** White aluminum
- **Pointer:** Black aluminum, adjustable
- **Case fill:** None, fillable
- **Accuracy:** ±2/1/2% of span (2½" size)  
±1% of span (4", 4½" and 6"size)
- **Datasheet:** 23X.50

| Type                     | 232.50 (Dry)   |   |
|--------------------------|--|---|
| Size                     | 2½"  |   |
| Connection               | LM  | CBM  |
| Conn. size               | ¼" NPT   |   |
| Press scale <sup>1</sup> | PSI  | PSI   |
| <b>List price</b>        | <b>\$99.20</b>   | <b>\$103.05</b>   |
| 30" Hg                   | 9110992  |   |
| 30"-0-15 psi             |  |   |
| 30"-0-30 psi             | 50812581   |   |
| 30"-0-60 psi             | 50430521   |   |
| 30"-0-100 psi            |  |   |
| 30"-0-160 psi            | 9111212  |   |
| 30"-0-200 psi            |  |   |
| <b>List price</b>        | <b>\$94.90</b>   | <b>\$98.75</b>  |
| 10 psi                   |  |   |
| 15 psi                   | 9111000  | 9110062   |
| 30 psi                   | 9111018  | 9110070   |
| 60 psi                   | 9111026  | 9110089   |
| 100 psi                  | 9111034  | 9110097   |
| 160 psi                  | 9111042  | 9110100   |
| 200 psi                  | 9111050  | 9110119   |
| 300 psi                  | 9111069  | 9110127   |
| 400 psi                  | 9111077  | 9110143   |
| 600 psi                  | 9111085  | 9110151   |
| 800 psi                  |  |   |
| 1,000 psi                | 9111107  | 9110178   |
| <b>List price</b>        | <b>\$102.65</b>  | <b>\$106.50</b>   |
| 1,500 psi                | 9111115  | 9110186   |
| 2,000 psi                | 9111123  | 9110194   |
| 3,000 psi                | 9111131  | 9110208   |
| 5,000 psi                | 9111140  | 9110216   |
| 10,000 psi               | 9111158  | 9110224   |
| <b>List price</b>        | <b>\$128.15</b>  | <b>\$132.00</b>   |
| 15,000 psi               | 52001733   |   |
| 20,000 psi               |  |   |









<sup>1</sup>Vacuum scale: 30" Hg outside in black; 760 mm Hg inside in red.

Factory stocked items shown in **bold print**.  
Items without part numbers are available - consult factory.

Reference page 63 for **232.50** options.

# INDUSTRIAL GAUGES

Mechanical Pressure > Industrial Gauges > 232.50

| Type                     | 232.50 (Dry)   |   |  |   |  |   |                 |
|--------------------------|--|---|--|---|--|---|-----------------|
|                          | 4"   |   | 4½"  |   | 6"   |   |                 |
| Size                     |  |   |  |   |  |   |                 |
| Connection               | LM  | LBM  | LM  | LBM  | LM  | LBM  |                 |
| Conn. size               | ½" NPT   |   | ½" NPT   |   | ½" NPT   |   |                 |
| Press scale <sup>1</sup> | PSI  | PSI   | PSI  | PSI   | PSI  | PSI/BAR   | PSI             |
| <b>List price</b>        | <b>\$166.80</b>  | <b>\$181.10</b>   | <b>\$171.40</b>  | <b>\$183.20</b>   | <b>\$338.00</b>  | <b>\$338.00</b>   | <b>\$356.00</b> |
| 30" Hg                   | 50369415   |   | 50474511   | 50474588  | 4213688  | 4213939   | 4214218         |
| 30"-0-15 psi             | 50578910   |   | 50474529   | 50474596  | 4213696  |   | 4214226         |
| 30"-0-30 psi             | 50308858   |   | 50474537   | 50474600  | 4213700  |   | 4214234         |
| 30"-0-60 psi             | 52005828   |   | 50474545   | 50474618  | 4213718  |   | 4214242         |
| 30"-0-100 psi            | 9365508  |   | 50474553   | 50474626  | 4213726  |   | 4214251         |
| 30"-0-160 psi            |  |   | 50474561   | 50474634  | 4213734  |   | 4214269         |
| 30"-0-200 psi            |  |   | 50474570   | 50474642  | 4213742  |   | 4214277         |
| <b>List price</b>        | <b>\$162.95</b>  | <b>\$177.25</b>   | <b>\$167.10</b>  | <b>\$178.90</b>   | <b>\$318.00</b>  | <b>\$318.00</b>   | <b>\$336.00</b> |
| 10 psi                   |  |   |  |   |  |   |                 |
| 15 psi                   | 9319492  |   | 50474171   | 50474359  | 4213751  | 4213947   | 4214285         |
| 30 psi                   | 50293303   |   | 50474197   | 50474367  | 4213769  | 4213955   | 4214293         |
| 60 psi                   | 9154671  |   | 50474201   | 50474375  | 4213777  | 4213963   | 4214307         |
| 100 psi                  | 9189459  | 50999452  | 50474219   | 50474383  | 4213785  | 4213971   | 4214315         |
| 160 psi                  | 9189467  |   | 50474235   | 50474391  | 4213793  | 4213981   | 4214323         |
| 200 psi                  | 9154701  |   | 50474243   | 50474405  | 4213807  |   | 4214331         |
| 300 psi                  | 9154710  |   | 50474251   | 50474413  | 4213815  | 4213999   | 4214340         |
| 400 psi                  | 9154728  |   | 50474260   | 50474421  | 4213823  |   | 4214358         |
| 600 psi                  |  |   | 50474278   | 50474430  | 4213831  | 4214005   | 4214366         |
| 800 psi                  |  |   | 50474286   | 50474448  | 4213840  |   |                 |
| 1,000 psi                | 9154752  | 50997591  | 50474294   | 50474456  | 4213858  | 4214013   | 4214382         |
| <b>List price</b>        | <b>\$167.70</b>  | <b>\$182.00</b>   | <b>\$172.50</b>  | <b>\$184.30</b>   | <b>\$428.00</b>  | <b>\$428.00</b>   | <b>\$446.00</b> |
| 1,500 psi                |  |   | 50474308   | 50474464  | 4213866  | 4214021   | 4214391         |
| 2,000 psi                | 9212744  |   | 50474316   | 50474472  | 4213874  |   | 4214404         |
| 3,000 psi                | 9232087  |   | 50474324   | 50474481  | 4213882  | 4214030   | 4214412         |
| 5,000 psi                | 9145664  |   | 50474332   | 50474499  | 4213891  | 4214048   | 4214421         |
| 10,000 psi               | 9319506  |   | 50474341   | 50474502  | 4213904  | 4214056   | 4214439         |
| <b>List price</b>        | <b>\$208.30</b>  | <b>\$222.60</b>   | <b>\$208.90</b>  | <b>\$220.70</b>   | <b>\$462.00</b>  | <b>\$462.00</b>   | <b>\$480.00</b> |
| 15,000 psi               |  |   | 50474651   | 50474677  | 4213912  | 4214064   | 4214447         |
| 20,000 psi               |  |   | 50474669   | 50474685  | 4213921  |   | 4214587         |

<sup>1</sup>Vacuum scale: 30" Hg outside in black; 760 mm Hg inside in red.

Factory stocked items shown in **bold print**. Items without part numbers are available - consult factory.

Reference pages 63 and 64 for **232.50** options.



# INDUSTRIAL GAUGES

Mechanical Pressure > Industrial Gauges > Options for 23X.50

## Options for type 23X.50

| Option   | Code                    | 23X.50<br>2½" LM | 23X.50<br>2½" CBM | 23X.50<br>4" LM | 23X.50<br>4" LBM |
|--|-------------------------|------------------|-------------------|-----------------|------------------|
| <b>Case liquid fills</b>   |                         |                  |                   |                 |                  |
| Glycerine  | 233.50                  | \$4.55           | \$4.55            | \$16.50         | \$16.50          |
| Glycerine / water (86.5 / 13.5)  | GLY86.5                 | \$7.80           | \$7.80            | \$20.70         | \$20.70          |
| Silicone 1,000 cst   | SIL1000                 | \$13.15          | \$13.15           | \$34.40         | \$34.40          |
| Silicone 50 cst  | SIL50                   | \$13.15          | \$13.15           | \$34.40         | \$34.40          |
| Silicone 350 cst   | SIL 350                 | \$13.15          | \$13.15           | \$34.40         | \$34.40          |
| <b>Connections</b>   |                         |                  |                   |                 |                  |
| 1/8" NPT or G1/8B  | 1/8 or G1/8             | \$0.00           | \$0.00            | n/a             | n/a              |
| G1/4B  | G1/4                    | \$0.00           | \$0.00            | \$0.00          | \$0.00           |
| G1/2B  | G1/2                    | n/a              | n/a               | \$0.00          | \$0.00           |
| 7/16-20 SAE  | SAE                     | \$23.80          | \$23.80           | \$23.80         | \$23.80          |
| R1/4-2999  | R1/4                    | \$9.25           | \$9.25            | n/a             | n/a              |
| 3, 9 or 12 O'clock position  | (3,9,12)CLK             | \$9.25           | n/a               | \$9.25          | n/a              |
| 10-32 internal tap   | 10-32                   | \$1.90           | \$1.90            | \$1.90          | \$1.90           |
| Teflon® tape on connection   | TT                      | \$0.70           | \$0.70            | \$0.70          | \$0.70           |
| <b>Mounting</b>  |                         |                  |                   |                 |                  |
| Front flange, SS polished  | FF                      | n/a              | \$31.20           | n/a             | \$43.95          |
| Rear flange, SS polished   | RF                      | \$24.25          | \$24.25           | \$33.55         | \$33.55          |
| UC, SS ring, SS bracket  | UC                      | n/a              | \$26.75           | n/a             | n/a              |
| <b>Windows</b>   |                         |                  |                   |                 |                  |
| Polycarbonate  | PC                      | Standard         | Standard          | \$0.00          | \$0.00           |
| <b>Pointers</b>  |                         |                  |                   |                 |                  |
| Drag pointer, red, acrylic window  | DP                      | \$80.05          | \$80.05           | \$100.05        | \$100.05         |
| Drag pointer, red, safety glass window   | DP SG                   | n/a              | n/a               | \$83.95         | \$83.95          |
| Mark pointer, red, on window   | MP                      | \$80.05          | \$80.05           | \$100.05        | \$100.05         |
| Mark pointer, red, on dial   | MPD                     | \$5.10           | \$5.10            | \$5.90          | \$5.90           |
| <b>Restrictors</b>   |                         |                  |                   |                 |                  |
| SS, M4 thread, 0.6mm orifice   | R                       | \$7.05           | \$7.05            | \$7.05          | \$7.05           |
| SS, M4 thread, 0.3mm orifice   | R0.3                    | \$8.10           | \$8.10            | \$8.10          | \$8.10           |
| <b>Dials &amp; scales</b>  |                         |                  |                   |                 |                  |
| Serial number on dial  | SER#                    | \$5.65           | \$5.65            | \$5.65          | \$5.65           |
| Receiver scales (3-15 PSI)   | REC                     | \$17.55          | \$17.55           | \$21.50         | \$21.50          |
| <b>Movements</b>   |                         |                  |                   |                 |                  |
| Dampened movement  | DAMP                    | \$15.00          | \$15.00           | \$15.00         | \$15.00          |
| <b>Other</b>   |                         |                  |                   |                 |                  |
| Clean for O2 service (ASME Level IV)   | O2                      | \$20.60          | \$20.60           | \$20.60         | \$20.60          |
| NACE compliance, MR0175 latest edition.<br>For 316L SS wetted parts; includes *NACE SOUR<br>GAS SERVICE* printed on dial | NACE                    | \$24.00          | \$24.00           | \$24.00         | \$24.00          |
| <b>Other Options available</b>   |                         |                  |                   |                 |                  |
| Calibration and material certificates  | Refer to pages 261, 262 |                  |                   |                 |                  |
| Special scales, logos and other artwork charges  | Refer to pages 263, 265 |                  |                   |                 |                  |
| Needle valves, siphons and other accessories   | Refer to pages 255-259  |                  |                   |                 |                  |

Shaded options are non-standard and may require extended lead-times

For datasheets and additional information, please visit [www.wika.com](http://www.wika.com) or call 1-888-945-2872.

# INDUSTRIAL GAUGES

Mechanical Pressure > Industrial Gauges > Options for 23X.50

## Options for type 23X.50

| Option   | Code                           | 23X.50<br>4½" LM | 23X.50<br>4½" LBM | 23X.50<br>6" LM | 23X.50<br>6" LBM |
|--|--------------------------------|------------------|-------------------|-----------------|------------------|
| <b>Case liquid fills</b>   |                                |                  |                   |                 |                  |
| Glycerine  | 233.50                         | \$19.70          | \$19.70           | \$39.95         | \$39.95          |
| Glycerine / water (86.5 / 13.5)  | GLY86.5                        | \$24.65          | \$24.65           | \$49.95         | \$49.95          |
| Silicone 1,000 cst   | SIL1000                        | \$52.95          | \$52.95           | \$68.50         | \$68.50          |
| Silicone 50 cst  | SIL50                          | \$52.95          | \$52.95           | \$68.50         | \$68.50          |
| Silicone 350 cst   | SIL 350                        | \$52.95          | \$52.95           | \$68.50         | \$68.50          |
| <b>Connections</b>   |                                |                  |                   |                 |                  |
| G1/4B or G1/2B   | G1/4 or G1/2                   | \$0.00           | \$0.00            | \$0.00          | \$0.00           |
| 7/16-20 SAE  | SAE                            | \$23.80          | \$23.80           | \$23.80         | \$23.80          |
| R1/4-2999  | R1/4                           | \$9.25           | \$9.25            | \$9.25          | \$9.25           |
| 3, 9 or 12 O'clock position  | (3,9,12) CLK                   | \$9.25           | n/a               | \$9.25          | n/a              |
| 10-32 internal tap   | 10-32                          | \$1.90           | \$1.90            | \$1.90          | \$1.90           |
| Teflon® tape on connection   | TT                             | \$0.70           | \$0.70            | \$0.70          | \$0.70           |
| <b>Mounting</b>  |                                |                  |                   |                 |                  |
| Front flange, SS polished  | FF                             | n/a              | \$43.40           | n/a             | \$87.00          |
| Rear flange, SS polished   | RF                             | \$33.25          | \$33.25           | \$63.85         | \$63.85          |
| UC, SS ring, SS bracket  | UC                             | n/a              | n/a               | n/a             | \$79.45          |
| <b>Windows</b>   |                                |                  |                   |                 |                  |
| Polycarbonate  | PC                             | \$0.00           | \$0.00            | \$0.00          | \$0.00           |
| <b>Pointers</b>  |                                |                  |                   |                 |                  |
| Drag pointer, red, safety glass window   | DP                             | \$100.05         | \$100.05          | \$144.60        | \$144.60         |
| Mark pointer, red, on window   | MP                             | \$100.05         | \$100.05          | \$132.00        | \$132.00         |
| Mark pointer, red, on dial   | MPD                            | \$7.40           | \$7.40            | \$7.40          | \$7.40           |
| <b>Restrictors</b>   |                                |                  |                   |                 |                  |
| SS, M4 thread, 0.6mm orifice   | R                              | \$7.05           | \$7.05            | \$7.05          | \$7.05           |
| SS, M4 thread, 0.3mm orifice   | R0.3                           | \$8.10           | \$8.10            | \$8.10          | \$8.10           |
| <b>Dials &amp; scales</b>  |                                |                  |                   |                 |                  |
| Serial number on dial  | SER#                           | \$5.65           | \$5.65            | \$5.65          | \$5.65           |
| Receiver scales (3-15 PSI)   | REC                            | \$17.55          | \$17.55           | \$21.00         | \$21.00          |
| <b>Other</b>   |                                |                  |                   |                 |                  |
| Clean for O2 service (ASME Level IV)   | O2                             | \$20.60          | \$20.60           | \$20.60         | \$20.60          |
| NACE compliance, MR0175 latest edition.<br>For 316L SS wetted parts; includes *NACE SOUR<br>GAS SERVICE* printed on dial | NACE                           | \$24.00          | \$24.00           | \$24.00         | \$24.00          |
| <b>Other options available</b>   |                                |                  |                   |                 |                  |
| Calibration and material certificates  | <i>Refer to pages 261, 262</i> |                  |                   |                 |                  |
| Special scales, logos and other artwork charges  | <i>Refer to pages 263, 265</i> |                  |                   |                 |                  |
| Needle valves, siphons and other accessories   | <i>Refer to pages 255-259</i>  |                  |                   |                 |                  |

Shaded options are non-standard and may require extended lead-times

# INDUSTRIAL GAUGES

Mechanical Pressure > Industrial Gauges > 212.34, 213.34

## Industrial Gauges - XSEL® Process Gauge

### Standard features

- **Case:** Black thermoplastic
- **Wetted parts:** Copper alloy
- **Window:** Acrylic
- **Window ring:** Black thermoplastic, threaded
- **Dial:** White aluminum
- **Pointer:** Black aluminum, adjustable
- **Case fill:** 212.34 - None  
213.34 - Glycerine
- **Accuracy:** ±0.5% of span
- **Datasheet:** 21X.34

| Type                           | 212.34   |                 | 213.34          |
|--------------------------------|--|-----------------|-----------------|
| <b>Size</b>                    | <b>4½"</b>   |                 |                 |
| <b>Connection</b>              | LM  |                 |                 |
| <b>Conn. size</b>              | ¼" NPT   | ½" NPT          | ¼" NPT          |
| <b>Press scale<sup>1</sup></b> | PSI  | PSI             | PSI             |
| <b>List price</b>              | <b>\$120.60</b>  | <b>\$120.60</b> | <b>\$149.00</b> |
| 30" Hg                         | 9834036  | 9834257         | 9834740         |
| 30"-0-15 psi                   | 9834044  | 9834265         | 9834758         |
| 30"-0-30 psi                   | 9834052  | 9834273         | 9834766         |
| 30"-0-60 psi                   | 9834060  | 9834281         | 9834775         |
| 30"-0-100 psi                  | 9834079  | 9834290         | 9834783         |
| 30"-0-160 psi                  | 9834087  | 9834303         | 9834791         |
| 30"-0-200 psi                  | 9834095  |                 | 9834805         |
| <b>List price</b>              | <b>\$120.60</b>  | <b>\$120.60</b> | <b>\$149.00</b> |
| 15 psi                         | <b>9834117</b>   | 9834338         | 9834813         |
| 30 psi                         | 9834125  | 9834346         | 9834821         |
| 60 psi                         | 9834133  | 9834354         | 9834839         |
| 100 psi                        | <b>9834141</b>   | <b>9834362</b>  | 9834847         |
| 160 psi                        | <b>9834150</b>   | 9834370         | 9834855         |
| 200 psi                        | <b>9834168</b>   | <b>9834389</b>  | 9834864         |
| 300 psi                        | <b>9834176</b>   | <b>9834397</b>  | 9834872         |
| 400 psi                        | 9834184  | 9834400         | 9834880         |
| 600 psi                        | 9834192  | 9834419         | 9834898         |
| 800 psi                        | 9834982  | 9834990         | 9834902         |
| 1,000 psi                      | 9834206  | 9834427         | 9834910         |
| <b>List price</b>              |  |                 |                 |
| 1,500 psi                      | N/A - See type 23X.34  |                 |                 |
| 2,000 psi                      | N/A - See type 23X.34  |                 |                 |
| 3,000 psi                      | N/A - See type 23X.34  |                 |                 |
| 5,000 psi                      | N/A - See type 23X.34  |                 |                 |
| 10,000 psi                     | N/A - See type 23X.34  |                 |                 |
| <b>List price</b>              |  |                 |                 |
| 15,000 psi                     | N/A - See type 23X.34  |                 |                 |
| 20,000 psi                     | N/A - See type 23X.34  |                 |                 |



XSEL®

<sup>1</sup> Vacuum scale: 30" Hg outside in black; 760 mm Hg inside in red.  
<sup>2</sup> 4½" panel mounting kit (uninstalled) including polished 304 SS ring

Factory stocked items shown in **bold print**.  
 Items without part numbers are available - consult factory.

Reference page 69 for **21X.34** options.

# INDUSTRIAL GAUGES

Mechanical Pressure > Industrial Gauges > 222.34

## Industrial Gauges - XSEL® Process Gauge

### Standard features

- **Case:** Black thermoplastic
- **Wetted parts:** 1019 steel alloy & 316L SS
- **Window:** Acrylic
- **Window ring:** Black thermoplastic, threaded
- **Dial:** White aluminum
- **Pointer:** Black aluminum, adjustable
- **Case fill:** 222.34 - None  
223.34 - Consult factory
- **Accuracy:** ±0.5% of span
- **Datasheet:** 22X.34

|                                |                 |
|--------------------------------|-----------------|
| <b>Type</b>                    | <b>222.34</b>   |
| <b>Size</b>                    | <b>4½"</b>      |
| <b>Connection</b>              | LM ●            |
| <b>Conn. size</b>              | ½" NPT          |
| <b>Press scale<sup>1</sup></b> | PSI             |
| <b>List price</b>              | <b>\$124.40</b> |
| 30" Hg                         | 4332670         |
| 30"-0-15 psi                   | 4353639         |
| 30"-0-30 psi                   | 4353647         |
| 30"-0-60 psi                   | 4353656         |
| 30"-0-100 psi                  | 4353664         |
| 30"-0-160 psi                  | 4353672         |
| 30"-0-200 psi                  | 4353680         |
| <b>List price</b>              | <b>\$124.40</b> |
| 15 psi                         | 4353532         |
| 30 psi                         | 4332688         |
| 60 psi                         | 4332696         |
| 100 psi                        | 4332709         |
| 160 psi                        | 4332717         |
| 200 psi                        | 4332725         |
| 300 psi                        | 4353698         |
| 400 psi                        | 4332733         |
| 600 psi                        | 4332741         |
| 800 psi                        | 4353702         |
| 1,000 psi                      | 4332751         |
| <b>List price</b>              | <b>\$124.40</b> |
| 1,500 psi                      | 4353728         |
| 2,000 psi                      | 4353736         |
| 3,000 psi                      | 4353745         |
| 5,000 psi                      | 4353753         |
| 10,000 psi                     |                 |
| <b>List price</b>              | <b>\$171.95</b> |
| 15,000 psi                     |                 |
| 20,000 psi                     |                 |



**XSEL®**

<sup>1</sup> Vacuum scale: 30" Hg outside in black; 760 mm Hg inside in red.

<sup>2</sup> 4½" panel mounting kit (uninstalled) including polished 304 SS ring

Factory stocked items shown in **bold print**.

Items without part numbers are available - consult factory.

Reference page 69 for **222.34** options.

# INDUSTRIAL GAUGES

Mechanical Pressure > Industrial Gauges > Options for 232.24, 233.34

## Industrial Gauges - XSEL® Process Gauge

### Standard features

- **Case:** Black thermoplastic
- **Wetted parts:** 316L SS
- **Window:** Acrylic
- **Window ring:** Black thermoplastic, threaded
- **Dial:** White aluminum
- **Pointer:** Black aluminum, adjustable
- **Case fill:** 232.34 - None  
233.34 - Glycerine
- **Accuracy:** ±0.5% of span
- **Datasheet:** 23X.34



MECHANICAL PRESSURE

| Type                     | 232.34 (Dry)    |                 |                        |                 |                 |                 | 233.34 (Filled) |                 |
|--------------------------|-----------------|-----------------|------------------------|-----------------|-----------------|-----------------|-----------------|-----------------|
| Size                     | 4½"             |                 |                        |                 | 6"              |                 | 4½"             |                 |
| Connection               | LM ●            |                 |                        |                 | LBM L           |                 | LM ●            |                 |
| Conn. size               | ¼" NPT          | ½" NPT          |                        |                 | ½" NPT          | ½" NPT          | ¼" NPT          | ½" NPT          |
| Press scale <sup>1</sup> | PSI             | PSI             | PSI/KG/CM <sup>2</sup> | PSI/KPA         | PSI             | PSI             | PSI             | PSI             |
| <b>List price</b>        | <b>\$130.70</b> | <b>\$130.70</b> | <b>\$130.70</b>        | <b>\$130.70</b> | <b>\$177.25</b> | <b>\$281.60</b> | <b>\$159.10</b> | <b>\$159.10</b> |
| 30" Hg                   | <b>9834478</b>  | 9834729         | 9696410                | 9837604         | 4217004         | 4317492         | 9833735         | 9833914         |
| 30"-0-15 psi             | 9834486         | <b>9834737</b>  | 9696428                | 9837566         | 50381580        | 4343191         | 9833744         | 9833922         |
| 30"-0-30 psi             | 9834494         | <b>9834745</b>  | 9696436                | 9837523         | 4220854         | 4343204         | 9833752         | <b>9833930</b>  |
| 30"-0-60 psi             | 9834508         | 9834753         | 9696445                | 9837485         | 50086766        | 50262084        | 9833760         | 9833948         |
| 30"-0-100 psi            | 9834516         | 9834761         | 9696453                | 9792818         | 4392197         | 4343221         | 9833778         | 9833956         |
| 30"-0-160 psi            | 9834524         | 9834770         | 9696461                |                 | 50086774        | 4228298         | 9833786         | 9833965         |
| 30"-0-200 psi            | 9834532         | 9834788         |                        | 9837361         | 4214628         |                 | 9833795         | 9833973         |
| 30"-0-300 psi            | 4260163         | 4260180         |                        |                 |                 | 4343255         |                 |                 |
| 30"-0-400 psi            | 4260171         | 4260198         |                        |                 |                 |                 |                 |                 |
| <b>List price</b>        | <b>\$130.70</b> | <b>\$130.70</b> | <b>\$130.70</b>        | <b>\$130.70</b> | <b>\$177.25</b> | <b>\$281.60</b> | <b>\$159.10</b> | <b>\$159.10</b> |
| 15 psi                   | 9834559         | <b>9834800</b>  | 9696479                | 9776885         | 4242131         | 4343271         | 9833808         | <b>9833981</b>  |
| 30 psi                   | <b>9834567</b>  | <b>9834818</b>  | 9696487                | 9837680         | 4247923         | 4317505         | 9833816         | <b>9833999</b>  |
| 60 psi                   | <b>9834575</b>  | <b>9834826</b>  | 9696495                | 9776877         | 9797607         | 4317513         | 9833825         | <b>9834006</b>  |
| 100 psi                  | <b>9834583</b>  | <b>9834834</b>  | <b>9696509</b>         | 9837760         | 9797615         | 4317590         | 9833833         | <b>9834015</b>  |
| 160 psi                  | <b>9834591</b>  | <b>9834842</b>  | <b>9696517</b>         | 9776869         | 9797624         | 4317521         | 9833841         | <b>9834023</b>  |
| 200 psi                  | <b>9834605</b>  | <b>9834850</b>  | <b>9696525</b>         | 9837841         | 9797632         | 4317531         | 9833859         | <b>9834031</b>  |
| 300 psi                  | <b>9834613</b>  | <b>9834869</b>  | <b>9696534</b>         | 9837884         | 9797640         | 4317549         | 9833867         | <b>9834049</b>  |
| 400 psi                  | 9834621         | <b>9834877</b>  | 9696542                | 8985116         | 9797658         | 4317573         | 9833875         | <b>9834057</b>  |
| 600 psi                  | <b>9834630</b>  | <b>9834885</b>  | 9696550                | 9837965         | 9797666         | 4317557         | 9833884         | <b>9834065</b>  |
| 800 psi                  | 9835008         | <b>9834974</b>  | 9696568                |                 | 9797675         | 4317581         | 9833905         | 9834155         |
| 1,000 psi                | <b>9834648</b>  | <b>9834893</b>  | 9696576                | 9778918         | 9797683         | 4317565         | 9833892         | <b>9834074</b>  |
| <b>List price</b>        | <b>\$130.70</b> | <b>\$130.70</b> | <b>\$130.70</b>        | <b>\$130.70</b> | <b>\$177.25</b> | <b>\$281.60</b> | <b>\$159.10</b> | <b>\$159.10</b> |
| 1,500 psi                | 9793318         | <b>9834907</b>  | 9696585                | 9838082         | 4247931         | 4343281         |                 | 9834082         |
| 2,000 psi                | 9793661         | <b>9834915</b>  | 9696593                | 9838120         | 4247940         | 4343299         |                 | 9834090         |
| 3,000 psi                | 9748911         | <b>9834923</b>  | 9696606                | 9838163         | 4247958         | 4343301         |                 | 9834104         |
| 5,000 psi                | 9793521         | <b>9834931</b>  | 9696615                | 9838201         | 4247966         | 4343310         |                 | 9834112         |
| 10,000 psi               | 9793679         | 9834940         | 9696623                | 9838244         | 50316761        |                 |                 | 9834120         |
| <b>List price</b>        | <b>\$177.45</b> | <b>\$177.45</b> | <b>\$177.45</b>        | <b>\$177.45</b> | <b>\$224.00</b> | <b>\$332.60</b> | <b>\$205.85</b> | <b>\$205.85</b> |
| 15,000 psi               |                 | 9834958         | 9696631                |                 |                 |                 |                 | 9834138         |
| 20,000 psi               | N/A             | 9834966         | 9696649                |                 |                 |                 | N/A             | 9834146         |

<sup>1</sup> "PSI/KG/CM<sup>2</sup>" denotes dual scale; PSI outside in black, KG/CM<sup>2</sup> inside in red. Note: Vacuum scale: 30" Hg outside in black; 760 mm Hg inside in red.

<sup>2</sup> 4½" panel mounting kit (uninstalled) including polished 304 SS ring

Factory stocked items shown in **bold print**. Items without part numbers are available - consult factory.

Reference page 69 for **23X.34** options.

For datasheets and additional information, please visit [www.wika.com](http://www.wika.com) or call 1-888-945-2872.

# INDUSTRIAL GAUGES

Mechanical Pressure > Industrial Gauges > 262.34

## Industrial Gauges -XSEL® Process Gauge

### Standard features

- **Case:** Black thermoplastic
- **Wetted parts:** Monel® 400 alloy
- **Window:** Acrylic
- **Window ring:** Black thermoplastic, threaded
- **Dial:** White aluminum
- **Pointer:** Black aluminum, adjustable
- **Case fill:** 262.34 - None  
263.34 - Glycerine
- **Accuracy:** ±0.5% of span
- **Datasheet:** 26X.34

| Type                     | 262.34   |
|--------------------------|--|
| Size                     | 4½"  |
| Connection               | LM  |
| Conn. size               | ½" NPT   |
| Press scale <sup>1</sup> | PSI  |
| List price               | \$358.00   |
| 30" Hg                   | 9835016  |
| 30"-0-15 psi             | 9835024  |
| 30"-0-30 psi             | 9835032  |
| 30"-0-60 psi             | 9835040  |
| 30"-0-100 psi            | 9835059  |
| 30"-0-160 psi            | 9835067  |
| 30"-0-200 psi            | 9835075  |
| List price               | \$358.00   |
| 15 psi                   | 9835091  |
| 30 psi                   | 9835105  |
| 60 psi                   | 9835113  |
| 100 psi                  | 9835121  |
| 160 psi                  | 9835130  |
| 200 psi                  | <b>9835148</b>   |
| 300 psi                  | 9835156  |
| 400 psi                  | 9835164  |
| 600 psi                  | <b>9835172</b>   |
| 800 psi                  | 9835180  |
| 1,000 psi                | 9835199  |
| List price               | \$358.00   |
| 1,500 psi                | 9835202  |
| 2,000 psi                | 9835210  |
| 3,000 psi                | 9835229  |
| 5,000 psi                | 9835237  |
| 10,000 psi               |  |



**XSEL®**

<sup>1</sup> Vacuum scale: 30" Hg outside in black; 760 mm Hg inside in red.

<sup>2</sup> 4½" panel mounting kit (uninstalled) including polished 304 SS ring

Factory stocked items shown in **bold print**.

Items without part numbers are available - consult factory.

Reference page 69 for **262.34** options.

# INDUSTRIAL GAUGES

Mechanical Pressure > Industrial Gauges > Options for 2XX.34

## Options for type 2XX.34

| Option   | Code         | 2XX.34<br>4½" LM        | 2XX.34<br>4½" LBM | 2XX.34<br>6" LM |
|--|--------------|-------------------------|-------------------|-----------------|
| <b>Case / ring options</b>   |              |                         |                   |                 |
| Red thermoplastic case & ring  | RCASE        | \$39.25                 | n/a               | n/a             |
| Yellow thermoplastic case & ring   | YCASE        | \$39.25                 | n/a               | n/a             |
| <b>Case liquid fills</b>   |              |                         |                   |                 |
| Dry, prepared for glycerine / silicone filling in field  |              | Standard                | \$27.65           | Standard        |
| Dry, prepared for Fluorolube® filling in field   |              | \$26.30                 | \$51.50           | \$26.30         |
| Glycerine  | 2X3.34       | \$28.40                 | \$28.40           | \$28.40         |
| Glycerine / water (86.5 / 13.5)  | GLY86.5      | \$34.40                 | \$34.40           | \$34.40         |
| Silicone 1,000 cst   | SIL1000      | \$52.95                 | \$52.95           | \$52.95         |
| Silicone 50 cst  | SIL50        | \$52.95                 | \$52.95           | \$52.95         |
| Silicone 350 cst   | SIL 350      | \$52.95                 | \$52.95           | \$52.95         |
| <b>Connections</b>   |              |                         |                   |                 |
| G1/4B or G1/2B   | G1/4 or G1/2 | \$0.00                  | \$0.00            | \$0.00          |
| 3/8" NPT or G3/8B  | 3/8 or G3/8  | \$0.00                  | \$0.00            | \$0.00          |
| 3, 9 or 12 O'clock position  | (3,9,12) CLK | \$9.25                  | n/a               | \$9.25          |
| Teflon® tape on connection   | TT           | \$0.70                  | \$0.70            | \$0.70          |
| <b>Mounting</b>  |              |                         |                   |                 |
| 4½" panel mount kit  | PM           | \$141.35                | \$141.35          | n/a             |
| <b>Windows</b>   |              |                         |                   |                 |
| Polycarbonate  | PC           | \$4.00                  | \$4.00            | n/a             |
| Flat glass   | GLS          | \$14.80                 | \$14.80           | n/a             |
| Safety glass   | SG           | \$23.45                 | \$23.45           | \$23.45         |
| <b>Pointers</b>  |              |                         |                   |                 |
| Knife-edge pointer   | KPTR         | \$3.15                  | \$3.15            | \$3.15          |
| Drag pointer, red  | DP           | \$75.00                 | \$75.00           | n/a             |
| <b>Restrictors</b>   |              |                         |                   |                 |
| SS, M4 thread, 0.6mm orifice   | R            | Standard                | Standard          | Standard        |
| SS, M4 thread, 0.3mm orifice   | R0.3         | \$8.10                  | \$8.10            | \$8.10          |
| <b>Dials &amp; scales</b>  |              |                         |                   |                 |
| Luminescent dial   | LUM          | \$9.35                  | \$9.35            | n/a             |
| Serial number on dial  | SER#         | \$5.65                  | \$5.65            | \$5.65          |
| Receiver scales (3-15 PSI)   | REC          | \$17.55                 | \$17.55           | \$21.50         |
| <b>Movements</b>   |              |                         |                   |                 |
| Dampened movement  | DM           | \$15.00                 | \$15.00           | \$15.00         |
| PTFE coated movement   | PTFE         | \$11.60                 | \$11.60           | \$11.60         |
| Zero adjustment screw on window  | EXT ADJ      | \$57.15                 | \$57.15           | n/a             |
| <b>Other</b>   |              |                         |                   |                 |
| Clean for O2 service (ASME Level IV)   | O2           | \$20.60                 | \$20.60           | \$20.60         |
| NACE compliance, MR0175 latest edition. For 316L SS wetted parts; includes *NACE SOUR GAS SERVICE* printed on dial | NACE         | \$24.00                 | \$24.00           | \$24.00         |
| NACE compliance, MR0175 latest edition. For MONEL® wetted parts; includes *NACE SOUR GAS SERVICE* printed on dial  | NACE         | \$5.00                  | \$5.00            | \$5.00          |
| <b>Other options available</b>   |              |                         |                   |                 |
| Calibration and material certificates  |              | Refer to pages 261, 262 |                   |                 |
| Special scales, logos and other artwork charges  |              | Refer to pages 263, 265 |                   |                 |
| Needle valves, siphons and other accessories   |              | Refer to pages 255-259  |                   |                 |
| Alarm contacts for process gauges  |              | Refer to page 260       |                   |                 |

Shaded options are non-standard and may require extended lead-times

For datasheets and additional information, please visit [www.wika.com](http://www.wika.com) or call 1-888-945-2872.

# INDUSTRIAL GAUGES

Mechanical Pressure > Industrial Gauges > 232.34DD

## Industrial Gauges - Direct Drive Process Gauge

### Standard features

- **Case:** Yellow thermoplastic, solid front
- **Wetted parts:** Inconel® X-750 & 316 SS
- **Window:** Polycarbonate
- **Window ring:** Stainless steel
- **Dial:** White aluminum
- **Pointer:** Black aluminum - adjustable
- **Case fill:** None
- **Accuracy:** ±0.5% of span
- **Datasheet:** 232.34DD

| Type          | 232.34DD |
|---------------|----------|
| Size          | 4½"      |
| Connection    | LM       |
| Conn. size    | ½" NPT   |
| Press scale   | PSI      |
| List price    | \$314.00 |
| 30"-0-30 psi  | 52049124 |
| 30"-0-60 psi  | 52049132 |
| 30"-0-150 psi | 52049141 |
| 30"-0-300 psi | 52049159 |
| List price    | \$314.00 |
| 30 psi        | 52049167 |
| 60 psi        | 52049183 |
| 100 psi       | 52049191 |
| 160 psi       | 52049205 |
| 200 psi       | 52049221 |
| 300 psi       | 52049230 |
| 500 psi       | 52049248 |
| 1,000 psi     | 52049256 |
| 1,500 psi     | 52049272 |
| 2,000 psi     | 52049281 |
| 3,000 psi     | 52049299 |
| 5,000 psi     | 52049302 |
| 10,000 psi    | 52049311 |





# INDUSTRIAL GAUGES

Mechanical Pressure > Industrial Gauges > Options for 232.34DD

## Options for type 232.34DD

| Option   | Code                           | 232.34DD<br>4½" LM  |
|--|--------------------------------|---------------------|
| <b>Case</b>  |                                |                     |
| Black thermoplastic  | BLK CS                         | <b>\$0.00</b>       |
| <b>Connections</b>   |                                |                     |
| G1/4B or G1/2B   | G1/4 or G1/2                   | <b>Call factory</b> |
| 3/8" NPT or G3/8B  | 3/8 or G3/8                    | <b>Call factory</b> |
| 9/16 - 18 UNF F250C female autoclave                             | F250C                          | <b>\$192.00</b>     |
| Teflon® tape on connection                                       | TT                             | <b>\$1.45</b>       |
| <b>Windows</b>   |                                |                     |
| Safety glass (without zero adjustment)                           | SG                             | <b>\$78.55</b>      |
| <b>Dials &amp; scales</b>  |                                |                     |
| Serial number on dial  | SER#                           | <b>\$5.65</b>       |
| Receiver scales (3-15 PSI)                                       | REC                            | <b>\$35.85</b>      |
| <b>Other</b>   |                                |                     |
| Clean for O2 service (ASME Level IV)                             | O2                             | <b>\$156.65</b>     |
| Viton® isolator (not for gas or vacuum service)                  | ISOL                           | <b>\$111.60</b>     |
| EPDM isolator (not for gas or vacuum service)                    | ISOL                           | <b>\$111.60</b>     |
| Porous filter (25-50 micron) <i>one included with each gauge</i> | FLT 25                         | <b>\$30.00</b>      |
| Porous filter (50-100 micron)                                    | FLT 100                        | <b>\$53.55</b>      |
| <b>Other options available</b>                                   |                                |                     |
| Calibration and material certificates                            | <i>Refer to pages 261, 262</i> |                     |
| Special scales, logos and other artwork charges                  | <i>Refer to pages 263, 265</i> |                     |
| Needle valves, siphons and other accessories                     | <i>Refer to pages 255-259</i>  |                     |

Shaded options are non-standard and may require extended lead-times

# INDUSTRIAL GAUGES

Mechanical Pressure > Industrial Gauges > 212.25, 232.25

## Industrial Gauges - Hinged Ring Gauges

### Standard features

- **Case:** Black-painted aluminum
- **Wetted parts:** Copper alloy - 212.25  
316L SS - 232.25
- **Window:** Flat glass
- **Window ring:** Black-painted steel, hinged
- **Dial:** White aluminum
- **Pointer:** Black aluminum, adjustable
- **Case fill:** None
- **Accuracy:** ±0.5% of span
- **Datasheet:** 212.25 or 232.25

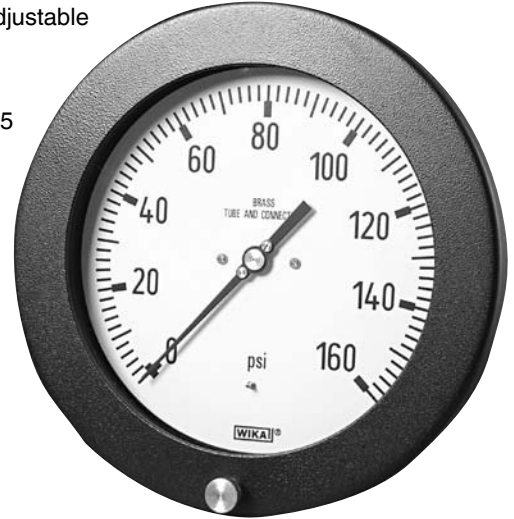

| Type                     | 212.25                |                 |                 | 232.25          |                 |                 |
|--------------------------|-----------------------|-----------------|-----------------|-----------------|-----------------|-----------------|
|                          | 4 1/2"                |                 | 6"              | 4 1/2"          |                 | 6"              |
| Size                     | LBM                   |                 |                 | LBM             |                 |                 |
| Connection               | LBM                   |                 |                 | LBM             |                 |                 |
| Conn. size               | 1/4" NPT              | 1/2" NPT        | 1/2" NPT        | 1/4" NPT        | 1/2" NPT        | 1/2" NPT        |
| Press scale <sup>1</sup> | PSI                   | PSI             | PSI             | PSI             | PSI             | PSI             |
| <b>List price</b>        | <b>\$277.00</b>       | <b>\$277.00</b> | <b>\$420.00</b> | <b>\$387.00</b> | <b>\$387.00</b> | <b>\$553.00</b> |
| 30" Hg                   | 4234970               | 4235223         | 4235976         | 4235470         | 4235721         | 4236220         |
| 30"-0-15 psi             | 4234988               | 4235231         | 4235984         | 4235488         | 4235739         | 4236238         |
| 30"-0-30 psi             | 4234996               | 4235240         | 4235992         | 4235496         | 4235747         | 4236246         |
| 30"-0-60 psi             | 4235002               | 4235258         | 4236009         | 4235509         | 4235755         | 4236254         |
| 30"-0-100 psi            | 4235011               | 4235266         | 4236017         | 4235517         | 4235763         | 4236262         |
| 30"-0-160 psi            | 4235029               | 4235274         | 4236025         | 4235525         | 4235771         | 4236271         |
| 30"-0-200 psi            | 4235037               | 4235282         | 4236033         | 4235533         | 4235780         | 4236280         |
| <b>List price</b>        | <b>\$265.00</b>       | <b>\$265.00</b> | <b>\$403.00</b> | <b>\$365.00</b> | <b>\$365.00</b> | <b>\$529.00</b> |
| 15 psi                   | 4235045               | 4235291         | 4236041         | 4235541         | 4235798         | 4236298         |
| 30 psi                   | 4235053               | 4235304         | 4236050         | 4235551         | 4235801         | 4236301         |
| 60 psi                   | 4235061               | 4235312         | 4236068         | 4235569         | 4235810         | 4236319         |
| 100 psi                  | 4235070               | 4235321         | 4236076         | 4235577         | 4235828         | 4236327         |
| 160 psi                  | 4235088               | 4235339         | 4236084         | 4235585         | 4235836         | 4236335         |
| 200 psi                  | 4235096               | 4235347         | 4236092         | 4235593         | 4235844         | 4236343         |
| 300 psi                  | 4235100               | 4235355         | 4236106         | 4235606         | 4235852         | 4236351         |
| 400 psi                  | 4235118               | 4235363         | 4236114         | 4235614         | 4235861         | 4236361         |
| 600 psi                  | 4235126               | 4235371         | 4236122         | 4235622         | 4235879         | 4236379         |
| 800 psi                  | 4235134               | 4235381         | 4236131         | 4235631         | 4235887         | 4236387         |
| 1,000 psi                | 4235142               | 4235399         | 4236149         | 4235640         | 4235895         | 4236395         |
| <b>List price</b>        |                       |                 |                 | <b>\$407.00</b> | <b>\$407.00</b> | <b>\$581.00</b> |
| 1,500 psi                | N/A - See type 232.25 |                 |                 | 4235658         | 4235909         | 4236408         |
| 2,000 psi                | N/A - See type 232.25 |                 |                 | 4235666         | 4235917         | 4236416         |
| 3,000 psi                | N/A - See type 232.25 |                 |                 | 4235674         | 4235925         | 4236424         |
| 5,000 psi                | N/A - See type 232.25 |                 |                 | 4235682         | 4235933         | 4236432         |
| 10,000 psi               | N/A - See type 232.25 |                 |                 | 4235691         | 4235941         | 4236441         |
| <b>List price</b>        |                       |                 |                 | <b>\$605.00</b> | <b>\$605.00</b> | <b>\$780.00</b> |
| 15,000 psi               | N/A - See type 232.25 |                 |                 | 4235703         | 4235950         | 4236450         |
| 20,000 psi               | N/A - See type 232.25 |                 |                 | 4235711         | 4235968         | 4236468         |

<sup>1</sup>Vacuum scale: 30" Hg outside in black; 760 mm Hg inside in red.

Factory stocked items shown in **bold print**. Items without part numbers are available - consult factory.

# INDUSTRIAL GAUGES

Mechanical Pressure > Industrial Gauges > Options for 212.25, 232.25

## Options for type 212.25, 232.25

| Option   | Code                           | 212.25  | 212.25  | 232.25  | 232.25  |
|--|--------------------------------|---------|---------|---------|---------|
|  |                                | 4½" LBM | 6" LBM  | 4½" LBM | 6" LBM  |
| <b>Connections</b>   |                                |         |         |         |         |
| G1/4B or G1/2B   | G1/4 or G1/2                   | \$0.00  | \$0.00  | \$0.00  | \$0.00  |
| Teflon® tape on connection   | TT                             | \$0.70  | \$0.70  | \$0.70  | \$0.70  |
| <b>Restrictors</b>   |                                |         |         |         |         |
| SS, M4 thread, 0.6mm orifice   | R                              | \$7.05  | \$7.05  | \$7.05  | \$7.05  |
| SS, M4 thread, 0.3mm orifice   | R0.3                           | \$8.10  | \$8.10  | \$8.10  | \$8.10  |
| <b>Dials &amp; scales</b>  |                                |         |         |         |         |
| Serial number on dial  | SER#                           | \$5.65  | \$5.65  | \$5.65  | \$5.65  |
| Receiver scales (3-15 PSI)   | REC                            | \$17.55 | \$21.50 | \$17.55 | \$21.50 |
| <b>Other</b>   |                                |         |         |         |         |
| Clean for O2 service (ASME Level IV)   | O2                             | \$20.60 | \$20.60 | \$20.60 | \$20.60 |
| NACE compliance, MR0175 latest edition.<br>For 316L SS wetted parts; includes *NACE SOUR<br>GAS SERVICE* printed on dial | NACE                           | \$24.00 | \$24.00 | \$24.00 | \$24.00 |
| <b>Other options available</b>   |                                |         |         |         |         |
| Calibration and material certificates  | <i>Refer to pages 261, 262</i> |         |         |         |         |
| Special scales, logos and other artwork charges  | <i>Refer to pages 263, 265</i> |         |         |         |         |
| Needle valves, siphons and other accessories   | <i>Refer to pages 255-259</i>  |         |         |         |         |

Shaded options are non-standard and may require extended lead-times

# INDUSTRIAL GAUGES

Mechanical Pressure > Industrial Gauges > 422.12, 432.12

## Industrial Gauges - Sealgauges

### Standard features

- **Case:** Black-painted cast iron
- **Wetted parts:** Carbon steel - 42X.12  
Stainless steel - 43X.12
- **Window:** Flat instrument glass
- **Window ring:** Black-painted steel
- **Dial:** White aluminum
- **Pointer:** Black aluminum, adjustable
- **Case fill:** None
- **Accuracy:** ±1.5% of span
- **Datasheet:** 42X.12 or 43X.12

| Type                     | 422.12          | 432.12          |
|--------------------------|-----------------|-----------------|
| Size                     | 4"              | 4"              |
| Connection               | LM              |                 |
| Conn. size               | ½" NPT Female   |                 |
| Press scale <sup>1</sup> | PSI             | PSI             |
| <b>List price</b>        | <b>\$310.00</b> | <b>\$546.00</b> |
| 30" Hg                   |                 | 9736336         |
| 30"-0-15 psi             |                 |                 |
| 30"-0-30 psi             |                 | 9740087         |
| 30"-0-60 psi             |                 | 9740095         |
| 30"-0-100 psi            |                 | 9744105         |
| 30"-0-160 psi            |                 |                 |
| 30"-0-200 psi            |                 |                 |
| <b>List price</b>        | <b>\$305.00</b> | <b>\$467.00</b> |
| 10 psi                   | 9744113         |                 |
| 15 psi                   |                 | 8683581         |
| 30 psi                   | 8558337         | 8558310         |
| 60 psi                   | 8681791         | 8683590         |
| 100 psi                  | 8558345         | 8657360         |
| 160 psi                  |                 | 8683603         |
| 200 psi                  | 8681813         | 9744121         |
| 300 psi                  |                 | 8547092         |
| 400 psi                  |                 | 9697565         |
| 600 psi                  | 9744139         | 8681236         |
| <b>List price</b>        | <b>\$611.00</b> | <b>\$796.00</b> |
| 5" H <sub>2</sub> O      |                 |                 |
| 10" H <sub>2</sub> O     |                 |                 |
| <b>List price</b>        | <b>\$493.00</b> | <b>\$628.00</b> |
| 15" H <sub>2</sub> O     |                 |                 |
| 30" H <sub>2</sub> O     |                 |                 |
| 60" H <sub>2</sub> O     |                 |                 |
| 100" H <sub>2</sub> O    |                 |                 |
| 200" H <sub>2</sub> O    |                 |                 |



<sup>1</sup>Vacuum scale: 30" Hg outside in black; 760 mm Hg inside in red.

Factory stocked items shown in **bold print**. Items without part numbers are available - consult factory.

# INDUSTRIAL GAUGES

Mechanical Pressure > Industrial Gauges > 432.50, 433.50

## Industrial Gauges - Sealgauges

### Standard features

- **Case:** 304 SS
- **Wetted parts:** 316L SS
- **Window:** Safety glass
- **Window ring:** SS, bayonet
- **Dial:** White aluminum
- **Pointer:** Black aluminum, adjustable
- **Case fill:** None - 432.50  
Glycerine - 433.50
- **Accuracy:**  $\pm 1.5\%$  of span
- **Datasheet:** 432.50

| Type                     | 432.50 (Dry)   | 433.50 (Filled) |
|--------------------------|--|-----------------|
| Size                     | 4"   | 4"              |
| Connection               | LM  |                 |
| Conn. size               | 1/2" NPT Female  |                 |
| Press scale <sup>1</sup> | PSI  | PSI             |
| List price               | \$913.00   | \$996.00        |
| 30" Hg                   |  |                 |
| 30"-0-15 psi             |  |                 |
| 30"-0-30 psi             | 9744147  |                 |
| 30"-0-60 psi             | 9744155  |                 |
| 30"-0-100 psi            |  |                 |
| 30"-0-160 psi            | 9744164  |                 |
| 30"-0-200 psi            |  |                 |
| List price               | \$907.00   | \$990.00        |
| 10 psi                   |  | 8737134         |
| 15 psi                   |  |                 |
| 30 psi                   | 8683360  | 9697603         |
| 60 psi                   | 8683379  | 8605548         |
| 100 psi                  | 8597952  | 8511950         |
| 160 psi                  | 8683387  | 8737118         |
| 200 psi                  | 9744172  | 8691320         |
| 300 psi                  | 8683409  | 8737126         |
| 400 psi                  | 9697581  | 8549176         |
| 600 psi                  | 9697599  | 8503370         |
| List price               | \$1,348.00   | \$1,425.00      |
| 5" H <sub>2</sub> O      |  |                 |
| 10" H <sub>2</sub> O     |  |                 |
| List price               | \$1,228.00   | \$1,303.00      |
| 15" H <sub>2</sub> O     |  |                 |
| 30" H <sub>2</sub> O     |  |                 |
| 60" H <sub>2</sub> O     |  |                 |
| 100" H <sub>2</sub> O    |  |                 |
| 200" H <sub>2</sub> O    | N/A  | N/A             |



<sup>1</sup>Vacuum scale: 30" Hg outside in black; 760 mm Hg inside in red.

Factory stocked items shown in **bold print**. Items without part numbers are available - consult factory.





# LOW PRESSURE GAUGES

Mechanical Pressure > Low Pressure Gauges > A2G-10, A2G-15

## Low Pressure Gauges - air2guide™

### Standard features

- **Case:** High-impact resistant plastic
- **Wetted parts:** Silicone rubber, plastic
- **Window:** Polycarbonate
- **Window ring:** None
- **Dial:** White aluminum with black segment
- **Pointer:** Black plastic
- **Accuracy:** ±3% of span
- **Connection:** Lower or back mount
- **Datasheet:** A2G-10, A2G-15

| Type                        | A2G-10   |   | A2G-15   |                      |   |                      |
|-----------------------------|--|---|--|----------------------|---|----------------------|
| Connection                  | LM  | CBM  | LM  |                      | CBM  |                      |
| Size                        | 4 1/2"   |   | 4 1/2"   |                      |   |                      |
| Conn. size                  | 2 x G 1/8 Female   |   | 2 x G 1/8 Female   |                      |   |                      |
| Mounting                    | Surface mount  | Panel mount   | Surface mount  |                      | Panel mount   |                      |
| Elect. output signal        | --   | --  | 4 ... 20 mA<br>2-wire  | 0 ... 10 V<br>3-wire | 4 ... 20 mA<br>2-wire   | 0 ... 10 V<br>3-wire |
| List Price:                 | <b>\$84.70</b>   | <b>\$84.70</b>  | <b>\$256.00</b>  | <b>\$256.00</b>      | <b>\$256.00</b>   | <b>\$256.00</b>      |
| -0.1/+0.1" H <sub>2</sub> O | 52294927   | 52216675  | 52296091   | 52297284             | 52297667  | 52297942             |
| -0.2/+0.2" H <sub>2</sub> O | 52294943   | 52216691  | 52296920   | 52297292             | 52297675  | 52297951             |
| -0.5/+0.5" H <sub>2</sub> O | 52294951   | 52216705  | 52296938   | 52297306             | 52297683  | 52297969             |
| -1/+1" H <sub>2</sub> O     | 52294960   | 52216748  | 52296946   | 52297314             | 52297691  | 52297985             |
| -2/+2" H <sub>2</sub> O     | 52294978   | 52216756  | 52296954   | 52297331             | 52297705  | 52297993             |
| -3/+3" H <sub>2</sub> O     | 52294986   | 52216764  | 52296971   | 52297349             | 52297713  | 52298001             |
| -4/+4" H <sub>2</sub> O     | 52294994   | 52216781  | 52296989   | 52297365             | 52297721  | 52298019             |
| -5/+5" H <sub>2</sub> O     | 52295036   | 52216799  | 52296997   | 52297357             | 52297730  | 52298027             |
| -6/+6" H <sub>2</sub> O     | 52295052   | 52216802  | 52297004   | 52297373             | 52297748  | 52298035             |
| 0/0.25" H <sub>2</sub> O    | 52295079   | 52216829  | 52297021   | 52297390             | 52297764  | 52298051             |
| 0/0.4" H <sub>2</sub> O     | 52295087   | 52216837  | 52297039   | 52297403             | 52297772  | 52298078             |
| List Price:                 | <b>\$73.95</b>   | <b>\$73.95</b>  | <b>\$233.45</b>  | <b>\$233.45</b>      | <b>\$233.45</b>   | <b>\$233.45</b>      |
| 0/0.5" H <sub>2</sub> O     | 52295559   | 52216845  | 52297047   | 52297411             | 52297781  | 52298060             |
| 0/1" H <sub>2</sub> O       | 52295567   | 52216853  | 52297144   | 52297420             | 52297802  | 52298086             |
| 0/2" H <sub>2</sub> O       | 52295575   | 52216861  | 52297152   | 52297438             | 52297811  | 52298094             |
| 0/3" H <sub>2</sub> O       | 52295583   | 52216870  | 52297161   | 52297446             | 52297829  | 52298108             |
| 0/4" H <sub>2</sub> O       | 52295613   | 52216888  | 52297187   | 52297454             | 52297845  | 52298116             |
| 0/5" H <sub>2</sub> O       | 52295621   | 52216896  | 52297195   | 52297462             | 52297853  | 52298124             |
| 0/6" H <sub>2</sub> O       | 52295630   | 52216900  | 52297209   | 52297471             | 52297861  | 52298132             |
| 0/8" H <sub>2</sub> O       | 52295648   | 52216918  | 52297217   | 52297489             | 52297870  | 52298141             |
| 0/10" H <sub>2</sub> O      | 52295656   | 52216926  | 52297225   | 52297497             | 52297888  | 52298167             |
| 0/15" H <sub>2</sub> O      | 52295672   | 52216942  | 52297241   | 52297519             | 52297900  | 52298183             |
| 0/20" H <sub>2</sub> O      | 52295681   | 52216951  | N/A  | N/A                  | N/A   | N/A                  |
| 0/25" H <sub>2</sub> O      | 52295699   | 52216969  | 52297250   | 52297527             | 52297918  | 52298191             |
| 0/30" H <sub>2</sub> O      | 52295702   | 52216977  | 52297268   | 52297535             | 52297926  | 52298205             |
| 0/50" H <sub>2</sub> O      | 52295711   | 52216993  | 52297276   | 52297543             | 52297934  | 52298213             |

NOTE: Each gauge is supplied with a pair of 1/8" to 3/16" hose barb adaptors and a set of case mounting screws.

Factory stocked items shown in **bold print**. Items without part numbers are available - consult factory.

# LOW PRESSURE GAUGES

Mechanical Pressure > Low Pressure Gauges > Options for A2G-10, A2G-15

## Options for type A2G-10, A2G-15

| Option   | Code | A2G-10<br>4½" LM               | A2G-10<br>4½" CBM | A2G-15<br>4½" LM | A2G-15<br>4½" CBM |
|--|------|--------------------------------|-------------------|------------------|-------------------|
| <b>Connections</b>                                   |      |                                |                   |                  |                   |
| Compression fitting, brass ½" NPT to ¼" metal tubing | CFIT | \$7.65                         | \$7.65            | \$7.65           | \$7.65            |
| <b>Other</b>   |      |                                |                   |                  |                   |
| Weather protection IP65 (NEMA 4)                     | IP65 | \$4.60                         | \$4.60            | \$4.60           | \$4.60            |
| Red mark pointer                                     | MP   | \$3.15                         | \$3.15            | \$3.15           | \$3.15            |
| <b>Other options available</b>                       |      |                                |                   |                  |                   |
| Calibration and material certificates                |      | <i>Refer to pages 261, 262</i> |                   |                  |                   |
| Special scales, logos and other artwork charges      |      | <i>No additional charge</i>    |                   |                  |                   |

Shaded options are non-standard and may require extended lead-times



A2G-10,  
Panel Mount



A2G-15  
Surface Mount

# LOW PRESSURE GAUGES

Mechanical Pressure > Low Pressure Gauges > 611.10

## Low Pressure Gauges - Black steel case, Brass wetted parts

### Standard features

- **Case:** Black-painted steel
- **Wetted parts:** Copper alloy
- **Window:** Snap-in acrylic
- **Window ring:** None
- **Dial:** White aluminum
- **Pointer:** Black aluminum
- **Case fill:** Not available
- **Accuracy:** ±1.5% of span
- **External zero adjustment screw on dial**
- **Datasheet:** 611.10

| Type               |                     | 611.10   |   |
|--------------------|---------------------|--|---|
| Size               |                     | 2½"  |   |
| Connection         |                     | LM  | CBM  |
| Conn. size         |                     | ¼" NPT   |   |
| List price         |                     | \$64.05  | \$67.25   |
| " H <sub>2</sub> O | mm H <sub>2</sub> O |  |   |
| 30 Vac             | 760                 | <b>9852344</b>   | 9851852   |
| 60 Vac             | 1500                | <b>9748321</b>   | 9748339   |
| 100 Vac            | 2500                | <b>9747473</b>   | <b>9747465</b>  |
| List price         |                     | \$64.05  | \$67.25   |
| " H <sub>2</sub> O | mm H <sub>2</sub> O |  |   |
| 10                 | 250                 | 50761846   | 50761871  |
| 15                 | 380                 | <b>9851682</b>   | <b>9851860</b>  |
| 30                 | 760                 | <b>9851690</b>   | <b>9855785</b>  |
| 60                 | 1500                | <b>9851704</b>   | 9803432   |
| 100                | 2500                | <b>9851810</b>   | 9851879   |
| 200                | 5000                | <b>9851828</b>   | 9851887   |
| List price         |                     | \$64.05  | \$67.25   |
| oz./sq. in.        | mm H <sub>2</sub> O |  |   |
| 10                 | 440                 | <b>9851771</b>   |   |
| 15                 | 660                 | <b>9851780</b>   |   |
| 20                 | 880                 | <b>9851798</b>   |   |
| 30                 | 1320                | <b>9851747</b>   | 9851917   |
| 35                 | 1540                | <b>9851801</b>   | <b>9857273</b>  |
| 60                 | 2640                | <b>9851755</b>   | 9803548   |
| List price         |                     | \$64.05  | \$67.25   |
| oz./sq. in.        | " H <sub>2</sub> O  |  |   |
| 20                 | 34                  | <b>9851720</b>   | <b>9857281</b>  |
| 32                 | 55                  | <b>9851739</b>   | 9855793   |
| List price         |                     | \$64.05  | \$67.25   |
| 3 psi              |                     | <b>9851925</b>   | <b>9851836</b>  |
| 5 psi              |                     | <b>9851933</b>   | <b>9851844</b>  |
| 10 psi             |                     | <b>4204212</b>   | <b>4204221</b>  |



Factory stocked items shown in **bold print**.

Items without part numbers are available. Minimum order quantities may apply - consult factory.

Reference page 81 for 611.10 options.



# LOW PRESSURE GAUGES

Mechanical Pressure > Low Pressure Gauges > 612.20

## Low Pressure Gauges - Stainless steel case, Brass wetted parts

### Standard features

- **Case:** 304 SS
- **Wetted parts:** Copper alloy
- **Window:** Flat glass
- **Window ring:** SS, bayonet
- **Dial:** White aluminum
- **Pointer:** Black aluminum
- **Case fill:** Not available
- **Accuracy:**  $\pm 1.5\%$  of span
- **External zero adjustment screw on dial**
- **Datasheet:** 612.20

| Type               |                     | 612.20   |
|--------------------|---------------------|--|
| Size               |                     | 4"   |
| Connection         |                     | LM  |
| Conn. size         |                     | 1/4" NPT   |
| List price         |                     | \$189.00   |
| " H <sub>2</sub> O | mm H <sub>2</sub> O |  |
| 30 Vac             | 760                 | 9747724  |
| 60 Vac             | 1500                |  |
| 100 Vac            | 2500                |  |
| List price         |                     | \$189.00   |
| " H <sub>2</sub> O | mm H <sub>2</sub> O |  |
| 15                 | 380                 | 9747732  |
| 30                 | 760                 | 9747740  |
| 60                 | 1500                | 9747758  |
| 100                | 2500                | <b>9747766</b>   |
| 200                | 5000                | <b>9747775</b>   |
| List price         |                     | \$189.00   |
| oz./sq. in.        | mm H <sub>2</sub> O |  |
| 10                 | 440                 |  |
| 15                 | 660                 |  |
| 20                 | 880                 |  |
| 30                 | 1320                |  |
| 35                 | 1540                |  |
| 60                 | 2640                |  |
| List price         |                     | \$189.00   |
| oz./sq. in.        | " H <sub>2</sub> O  |  |
| 20                 | 34                  |  |
| 32                 | 55                  |  |
| List price         |                     | \$189.00   |
| 3 psi              |                     | 9747783  |
| 5 psi              |                     | <b>9747791</b>   |
| 10 psi             |                     | 4246684  |

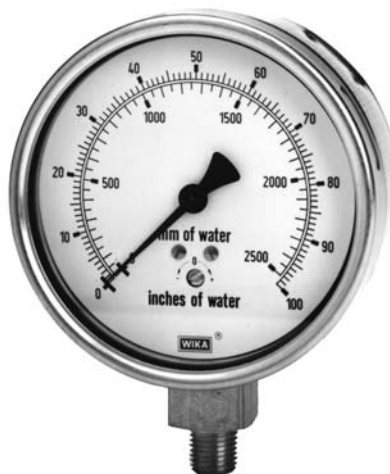

Factory stocked items shown in **bold print**.

Items without part numbers are available. Minimum order quantities may apply - consult factory.

Reference page 81 for 612.20 options.

# LOW PRESSURE GAUGES

Mechanical Pressure > Low Pressure Gauges > 632.50

## Low Pressure Gauges - Stainless steel case, 316L SS wetted parts

### Standard features

- **Case:** 304 SS
- **Wetted parts:** 316L SS
- **Window:** Safety glass
- **Window ring:** SS, bayonet
- **Dial:** White aluminum
- **Pointer:** Black aluminum
- **Case fill:** Not available
- **Accuracy:**  $\pm 1.5\%$  of span
- **External zero adjustment screw on dial**
- **Datasheet:** 632.50

| Type                        | 632.50   |
|-----------------------------|--|
| Size                        | 4"   |
| Connection                  | LM  |
| Conn. size                  | 1/2" NPT   |
| List price                  | \$650.00   |
| 5-0-5" H <sub>2</sub> O     | 9804439  |
| 10-0-10" H <sub>2</sub> O   | 9804447  |
| 15-0-15" H <sub>2</sub> O   | 9804455  |
| 15" H <sub>2</sub> O-0-5psi | 9804412  |
| 15" H <sub>2</sub> O        | 9804323  |
| 20" H <sub>2</sub> O        | 9804471  |
| 30" H <sub>2</sub> O        | 9804315  |
| 60" H <sub>2</sub> O        | 9804498  |
| 100" H <sub>2</sub> O       | 9859314  |
| 200" H <sub>2</sub> O       | 9804501  |
| 5 psi                       | 9804307  |
| 10 psi                      | 9804420  |



Factory stocked items shown in **bold print**.

Items without part numbers are available. Minimum order quantities may apply - consult factory.

# LOW PRESSURE GAUGES

Mechanical Pressure > Low Pressure Gauges > Options for 611.10, 612.20, 632.50

## Options for type 611.10, 612.20, 632.50

NOTE: 250 pc minimum order quantity is required for Type 611.10 shaded options. Consult factory for smaller quantities.

| Option  | Code                    | 611.10<br>2½" LM | 611.10<br>2½" CBM | 612.20<br>4" LM | 632.50<br>4" LM |
|---|-------------------------|------------------|-------------------|-----------------|-----------------|
| <b>Case / ring options</b>                      |                         |                  |                   |                 |                 |
| Stainless steel case                            | SS CASE                 | \$30.30          | \$30.30           | STD             | STD             |
| Chrome-plated steel case                        | CHR CASE                | \$6.70           | \$6.70            | n/a             | n/a             |
| <b>Connections</b>                              |                         |                  |                   |                 |                 |
| 1/8" NPT  | 1/8                     | \$0.00           | \$0.00            | \$0.00          | \$0.00          |
| G1/8B or G1/4B                                  | G1/8 or G1/4            | \$0.00           | \$0.00            | \$0.00          | \$0.00          |
| 1/2" NPT  | 1/2                     | n/a              | n/a               | \$0.00          | \$0.00          |
| G1/2B   | G1/2                    | n/a              | n/a               | \$0.00          | \$0.00          |
| 3, 9 or 12 O'clock position                     | (3,9,12)CLK             | \$28.05          | n/a               | \$28.05         | \$28.05         |
| Nickel-plated connection                        | NKL SKT                 | \$3.70           | \$3.70            | n/a             | n/a             |
| Teflon® tape on connection                      | TT                      | \$0.70           | \$0.70            | \$0.70          | \$0.70          |
| <b>Mounting</b>                                 |                         |                  |                   |                 |                 |
| Front flange, black-painted steel               | FF                      | \$14.95          | \$14.95           | n/a             | n/a             |
| Front flange, chrome-plated brass               | FF CHR                  | \$20.80          | \$20.80           | n/a             | n/a             |
| Front flange, SS polished                       | FF                      | n/a              | n/a               | \$36.00         | \$60.35         |
| Rear flange, black-painted steel                | RF                      | \$22.10          | \$22.10           | n/a             | n/a             |
| Rear flange, SS                                 | RF                      | n/a              | n/a               | \$32.40         | \$39.50         |
| U-clamp, SS polished ring, steel bracket        | UC                      | \$20.35          | \$20.35           | \$21.75         | \$36.00         |
| U-clamp, black-painted ring, steel bracket      | UC B                    | \$20.35          | \$20.35           | n/a             | n/a             |
| <b>Windows</b>                                  |                         |                  |                   |                 |                 |
| Flat glass                                      | GLS                     | \$3.60           | \$3.60            | std             | \$0.00          |
| Safety glass                                    | SG                      | \$21.50          | \$21.50           | \$10.55         | std             |
| <b>Pointers</b>                                 |                         |                  |                   |                 |                 |
| Drag pointer, red                               | DP                      | n/a              | n/a               | n/a             | \$120.15        |
| Mark pointer, red, adjustable                   | MP                      | \$5.70           | \$5.70            | \$13.80         | \$91.90         |
| <b>Restrictors</b>                              |                         |                  |                   |                 |                 |
| Brass, press-fit, 0.3mm orifice                 | R                       | \$4.10           | \$4.10            | \$4.10          | n/a             |
| SS, M4 thread, 0.6mm orifice                    | R                       | n/a              | n/a               | n/a             | \$7.05          |
| SS, M4 thread, 0.3mm orifice                    | R0.3                    | n/a              | n/a               | n/a             | \$8.10          |
| <b>Dials &amp; scales</b>                       |                         |                  |                   |                 |                 |
| Serial number on dial                           | SER#                    | \$5.80           | \$5.80            | \$5.80          | \$5.80          |
| <b>Other</b>                                    |                         |                  |                   |                 |                 |
| Accuracy ±1.0%                                  | 1%                      | n/a              | n/a               | n/a             | \$78.85         |
| 316 SS wetted parts                             | 631.11                  | \$227.35         | \$227.35          | n/a             | std             |
| Clean for O2 service (ASME Level IV)            | O2                      | \$34.50          | \$34.50           | \$34.50         | \$34.50         |
| Overpressure safe <sup>1</sup>                  | OP                      | \$20.15          | \$20.15           | \$20.15         | \$20.15         |
| Vacuum safe <sup>1</sup>                        | VS                      | \$20.15          | \$20.15           | \$20.15         | \$20.15         |
| Overpressure and vacuum safe <sup>1</sup>       | VS OP                   | \$40.05          | \$40.05           | \$40.05         | \$40.05         |
| <b>Other options available</b>                  |                         |                  |                   |                 |                 |
| Calibration and material certificates           | Refer to pages 261, 262 |                  |                   |                 |                 |
| Special scales, logos and other artwork charges | Refer to pages 263, 265 |                  |                   |                 |                 |
| Needle valves, siphons and other accessories    | Refer to pages 255-259  |                  |                   |                 |                 |

<sup>1</sup> 3X for ranges up to 10" H2O, 10X for higher ranges

Shaded options are non-standard and may require extended lead-times

# LOW PRESSURE GAUGES

Mechanical Pressure > Low Pressure Gauges > 612.34, 632.34

## Low Pressure Gauges - 4½" Process Gauge Case

### Standard features

- **Case:** Black thermoplastic
- **Wetted parts:** Copper alloy - 612.34  
316L SS - 632.34
- **Window:** Acrylic
- **Window ring:** Black thermoplastic, threaded
- **Dial:** White aluminum
- **Pointer:** Black aluminum, adjustable
- **Case fill:** Not available
- **Accuracy:** ±2/1/2% of span
- **Datasheet:** 6X2.34

| Type                  |                        | 612.34         | 632.34         |
|-----------------------|------------------------|----------------|----------------|
| Size                  |                        | 4½"            |                |
| Connection            |                        | LM             |                |
| Conn. size            |                        | ¼" NPT         |                |
| List price            |                        | \$518.00       | \$843.00       |
| Outer scale           | Inner scale            |                |                |
| 10" H <sub>2</sub> O  | 6 oz./in <sup>2</sup>  | 4217063        | 4217187        |
| 15" H <sub>2</sub> O  | 9 oz./in <sup>2</sup>  | 4217071        | 4217195        |
| 20" H <sub>2</sub> O  | 12 oz./in <sup>2</sup> | 4217080        | 4217209        |
| 30" H <sub>2</sub> O  | 18 oz./in <sup>2</sup> | <b>4217098</b> | <b>4217217</b> |
| 40" H <sub>2</sub> O  | 24 oz./in <sup>2</sup> | 4217101        | 4217225        |
| 60" H <sub>2</sub> O  | 35 oz./in <sup>2</sup> | 4217110        | 4217233        |
| 80" H <sub>2</sub> O  | 45 oz./in <sup>2</sup> | 4217128        | 4217241        |
| 100" H <sub>2</sub> O | 57 oz./in <sup>2</sup> | 4217136        | 4217250        |
| 150" H <sub>2</sub> O | 90 oz./in <sup>2</sup> | 4217144        | 4217268        |
| 5 psi                 | 10" Hg                 | 4217039        | 4217152        |
| 8 psi                 | 16" Hg                 | 4217047        | 4217161        |
| 10 psi                | 20" Hg                 | 4217055        | 4217179        |



Factory stocked items shown in **bold print**.

Items without part numbers are available - consult factory.

# LOW PRESSURE GAUGES

Mechanical Pressure > Low Pressure Gauges > Options for 612.34, 632.34

## Options for type 612.34, 632.34

| Option   | Code                           | 612.34<br>4½" LM | 632.34<br>4½" LM |
|--|--------------------------------|------------------|------------------|
| <b>Connections</b>   |                                |                  |                  |
| G1/4B or G1/2B   | G1/4 or G1/2                   | \$0.00           | \$0.00           |
| 1/2" NPT   | 1/2                            | \$0.00           | \$0.00           |
| 3, 9 or 12 O'clock position  | (3,9,12)CLK                    | \$9.55           | n/a              |
| Teflon® tape on connection   | TT                             | \$0.70           | \$0.70           |
| <b>Mounting</b>  |                                |                  |                  |
| 4½" panel mount kit  | PM                             | \$141.35         | \$141.35         |
| <b>Windows</b>   |                                |                  |                  |
| Flat glass   | GLS                            | \$14.80          | \$14.80          |
| Safety glass   | SG                             | \$23.45          | \$23.45          |
| <b>Pointers</b>  |                                |                  |                  |
| Drag pointer, red on acrylic window  | DP                             | \$75.00          | \$75.00          |
| Mark pointer, red, on dial   | MP                             | \$11.50          | \$11.50          |
| <b>Restrictors</b>   |                                |                  |                  |
| Brass, press-fit, 0.3mm orifice  | R                              | \$4.00           | \$4.00           |
| Brass, press-fit, 0.6mm orifice  | R0.6                           | \$4.00           | \$4.00           |
| SS, M4 thread, 0.6mm orifice   | R                              | \$7.05           | \$7.05           |
| SS, M4 thread, 0.3mm orifice   | R0.3                           | \$7.05           | \$7.05           |
| <b>Dials &amp; scales</b>  |                                |                  |                  |
| Serial number on dial  | SER#                           | \$5.65           | \$5.65           |
| <b>Other</b>   |                                |                  |                  |
| Clean for O2 service (ASME Level IV)   | O2                             | \$30.00          | \$30.00          |
| NACE compliance, MR0175 latest edition.<br>For 316L SS wetted parts; includes *NACE SOUR<br>GAS SERVICE* printed on dial | NACE                           | n/a              | \$24.00          |
| Overpressure safe <sup>1</sup>   | OP                             | \$19.55          | \$19.55          |
| Vacuum safe <sup>1</sup>   | VS                             | \$19.55          | \$19.55          |
| Overpressure and vacuum safe <sup>1</sup>  | VS OP                          | \$38.85          | \$38.85          |
| <b>Other options available</b>   |                                |                  |                  |
| Calibration and material certificates  | <i>Refer to pages 261, 262</i> |                  |                  |
| Special scales, logos and other artwork charges  | <i>Refer to pages 263, 265</i> |                  |                  |
| Needle valves, siphons and other accessories   | <i>Refer to pages 255-259</i>  |                  |                  |

<sup>1</sup> 3X for ranges up to 10" H2O, 10X for higher ranges

Shaded options are non-standard and may require extended lead-times

# DIFFERENTIAL PRESSURE GAUGES

Mechanical Pressure > Differential Gauges > 700.04

## Differential Pressure Gauges - Piston Style

### Standard features

- **Case:** Black thermoplastic
- **Wetted parts:** - Ceramic magnet  
- 316 SS spring  
- Viton® o-rings  
- Sensor housing anodized aluminum or 316L SS
- **Window:** Acrylic
- **Window ring:** Black thermoplastic
- **Dial:** White aluminum
- **Pointer:** Black aluminum
- **Case fill:** None - 700.04  
Glycerine - 703.04
- **Accuracy:** ±2% of span
- **Datasheet:** 700.04

| Type           | 700.04                  |                 |                 |                 |
|----------------|-------------------------|-----------------|-----------------|-----------------|
| Sensor housing | Anodized aluminum       |                 | 316L SS         |                 |
| Size           | <b>2½"</b>              | <b>4½"</b>      | <b>2½"</b>      | <b>4½"</b>      |
| Conn. size     | 2 x ¼" NPT Female, Back |                 |                 |                 |
| List price     | <b>\$279.00</b>         | <b>\$293.00</b> | <b>\$488.00</b> | <b>\$502.00</b> |
| 5 psid         | 4390954                 | 4390632         | 4390675         | 50334085        |
| 10 psid        | 4375242                 | 4371866         | 4368084         | 4372170         |
| 20 psid        | 4375250                 | 4368092         | 4371816         | 4372188         |
| 25 psid        | <b>4375268</b>          | 4371883         | 4371824         | 4372196         |
| 30 psid        | 4390616                 | 4390658         | 4390691         | 4390739         |
| 50 psid        | 4375276                 | 4371891         | 4371832         | 4372209         |
| 60 psid        | 50420267                | 4390666         |                 | 50441647        |
| 75 psid        | 4375285                 |                 | 4371840         |                 |
| 100 psid       | 4375293                 | 4371913         | 4371858         | 4372162         |



Factory stocked items shown in **bold print**.  
Items without part numbers are available - consult factory.

# DIFFERENTIAL PRESSURE GAUGES

Mechanical Pressure > Differential Gauges > Options for 700.04

## Options for type 700.04

| Option  | Code                           | 700.04<br>2½" | 700.04<br>4½" |
|---|--------------------------------|---------------|---------------|
| <b>Case liquid fills</b>                        |                                |               |               |
| Glycerine                                       | 703.04                         | \$45.30       | \$45.30       |
| Glycerine / water (86.5 / 13.5)                 | GLY86.5                        | \$51.60       | \$51.60       |
| Silicone 1,000 cst                              | SIL1000                        | \$56.15       | \$56.15       |
| Silicone 50 cst                                 | SIL50                          | \$56.15       | \$56.15       |
| Silicone 350 cst                                | SIL 350                        | \$56.15       | \$56.15       |
| <b>Connections</b>                              |                                |               |               |
| 2 x 1/4" NPT female end connections             | 1/4E                           | \$13.75       | \$13.75       |
| 2 x 1/2" NPT SS adapters                        | 1/2                            | \$65.20       | \$65.20       |
| <b>Mounting</b>                                 |                                |               |               |
| Wall / pipe-mount kit                           | MKIT                           | \$81.40       | \$81.40       |
| <b>Windows</b>                                  |                                |               |               |
| Safety glass                                    | SG                             | \$8.30        | \$8.70        |
| <b>Pointers</b>                                 |                                |               |               |
| Drag pointer, red                               | DP                             | \$60.00       | \$96.40       |
| <b>Dials &amp; scales</b>                       |                                |               |               |
| Serial number on dial                           | SER#                           | \$5.65        | \$5.65        |
| <b>Other</b>                                    |                                |               |               |
| Clean for O2 service (ASME Level IV)            | O2                             | \$38.45       | \$38.45       |
| 1 x SPDT 5W contact                             | SPDT                           | \$171.60      | \$171.60      |
| Bi-directional reading                          | BD                             | \$38.45       | \$38.45       |
| <b>Other options available</b>                  |                                |               |               |
| Calibration and material certificates           | <i>Refer to pages 261, 262</i> |               |               |
| Special scales, logos and other artwork charges | <i>Refer to pages 263, 265</i> |               |               |
| Needle valves, siphons and other accessories    | <i>Refer to pages 255-259</i>  |               |               |

Shaded options are non-standard and may require extended lead-times

# DIFFERENTIAL PRESSURE GAUGES

Mechanical Pressure > Differential Gauges > 700.05

## Differential Pressure Gauges - Piston-Style with Separating Diaphragm

### Standard features

- **Case:** Black thermoplastic
- **Wetted parts:** - Ceramic magnet  
- 316 SS spring  
- Buna-N membrane & o-rings  
- Sensor housing anodized aluminum or 316L SS
- **Window:** Acrylic
- **Window ring:** Black thermoplastic
- **Dial:** White aluminum
- **Pointer:** Black aluminum
- **Case fill:** None - 700.05  
Glycerine - 703.05
- **Accuracy:** ±2% of span, ranges 300" H2O & up  
±5% of span, ranges < 300" H2O
- **Datasheet:** 700.05

| Type                    | 700.05                  |                 |                 |                 |
|-------------------------|-------------------------|-----------------|-----------------|-----------------|
| Sensor housing          | Anodized aluminum       |                 | 316L SS         |                 |
| Size                    | <b>2½"</b>              | <b>4½"</b>      | <b>2½"</b>      | <b>4½"</b>      |
| Conn. size              | 2 x ¼" NPT Female, Back |                 |                 |                 |
| List price              | <b>\$440.00</b>         | <b>\$464.00</b> | <b>\$812.00</b> | <b>\$836.00</b> |
| 0/50" H <sub>2</sub> O  | 4375306                 | 4375446         | 4375586         | 4375722         |
| 0/75" H <sub>2</sub> O  | 4375315                 | 4375455         | 4375595         | 4375730         |
| 0/100" H <sub>2</sub> O | 4375323                 | 4375463         | 4375608         | 4375748         |
| 0/200" H <sub>2</sub> O | 4375331                 | 4375471         | 4375616         | 4375756         |
| 0/300" H <sub>2</sub> O | 4375349                 | 4375489         | 4375625         | 4375765         |
| 0/400" H <sub>2</sub> O | 4375357                 | 4375497         | 4375633         | 4375773         |
| 0/5 psid                | 4375366                 | 4375501         | 4375641         | 4375781         |
| 0/10 psid               | 4375374                 | 4375519         | 4375659         | 4375799         |
| 0/15 psid               | 4375382                 | 4375527         | 4375667         | 4375803         |
| 0/25 psid               | 4375390                 | 4375536         | 4375676         | 4375811         |
| 0/30 psid               | 4375404                 | 4375544         | 4375684         | 4375829         |
| 0/50 psid               | 4375412                 | 4375552         | 4375692         | 4375837         |
| 0/75 psid               | 4375420                 | 4375560         | 4375706         | 4375846         |
| 0/100 psid              | 4375438                 | 4375578         | 4375714         | 4375854         |



Factory stocked items shown in **bold print**.

Items without part numbers are available - consult factory.



# DIFFERENTIAL PRESSURE GAUGES

Mechanical Pressure > Differential Gauges > Options for 700.05

## Options for type 700.05

| Option  | Code                           | 700.05<br>2½" | 700.05<br>4½" |
|---|--------------------------------|---------------|---------------|
| <b>Case liquid fills</b>                        |                                |               |               |
| Glycerine                                       | 703.04                         | \$45.30       | \$45.30       |
| Glycerine / water (86.5 / 13.5)                 | GLY86.5                        | \$51.60       | \$51.60       |
| Silicone 1000 cst                               | SIL1000                        | \$56.15       | \$56.15       |
| Silicone 50 cst                                 | SIL50                          | \$56.15       | \$56.15       |
| Silicone 350 cst                                | SIL 350                        | \$56.15       | \$56.15       |
| <b>Connections</b>                              |                                |               |               |
| 2 x 1/2" NPT SS adapters                        | 1/2                            | \$65.20       | \$65.20       |
| <b>Mounting</b>                                 |                                |               |               |
| Wall / pipe-mount kit                           | MKIT                           | \$81.40       | \$81.40       |
| <b>Windows</b>                                  |                                |               |               |
| Safety glass                                    | SG                             | \$8.30        | \$8.70        |
| <b>Pointers</b>                                 |                                |               |               |
| Drag pointer, red                               | DP                             | \$60.00       | \$96.40       |
| <b>Dials &amp; scales</b>                       |                                |               |               |
| Serial number on dial                           | SER#                           | \$5.65        | \$5.65        |
| <b>Other</b>                                    |                                |               |               |
| Clean for O2 service (ASME Level IV)            | O2                             | \$38.45       | \$38.45       |
| Viton® membrane & o-rings                       | Viton                          | \$8.55        | \$8.55        |
| <b>Other options available</b>                  |                                |               |               |
| Calibration and material certificates           | <i>Refer to pages 261, 262</i> |               |               |
| Special scales, logos and other artwork charges | <i>Refer to pages 263, 265</i> |               |               |
| Needle valves, siphons and other accessories    | <i>Refer to pages 255-259</i>  |               |               |

Shaded options are non-standard and may require extended lead-times

# DIFFERENTIAL PRESSURE GAUGES

Mechanical Pressure > Differential Gauges > 712.15

## Differential Pressure Gauges - Cryogenic Liquid Level Gauges

### Standard features

- **Case:** 304 SS
- **Wetted parts:** Copper alloy, SS & NBR
- **Window:** Polycarbonate
- **Window ring:** SS, bayonet
- **Dial:** White aluminum
- **Pointer:** Black aluminum
- **Case fill:** None
- **Accuracy:**  $\pm 2\%$  of span
- **Datasheet:** 712.15

| Type       | 712.15   |
|------------|--|
| Size       | 6"   |
| Connection | LM  |
| Conn. size | 2 x 1/4" NPT Female  |
| List price | \$1,700.00   |
| 0/50" WC   | 50696246   |
| 0/100" WC  | 50696262   |
| 0/150" WC  | 50696271   |
| 0/200" WC  | 50696289   |
| 0/250" WC  | 50696297   |
| 0/300" WC  | 50696301   |
| 0/350" WC  | 50696319   |
| 0/400" WC  | 50696327   |
| 0/450" WC  | 50696335   |
| 0/500" WC  | 50696343   |
| 0/600" WC  | 50696351   |
| 0/700" WC  | 50696360   |
| 0/800" WC  | 50696378   |
| 0/900" WC  | 50696386   |



Factory stocked items shown in **bold print**.  
Items without part numbers are available - consult factory.

# DIFFERENTIAL PRESSURE GAUGES

Mechanical Pressure > Differential Gauges > Options for 712.15

## Options for type 712.15

| Option  | Code                           | 712.15<br>6" |
|---|--------------------------------|--------------|
| <b>Connections</b>                              |                                |              |
| 2 x G1/4B                                       | G1/4                           | \$0.00       |
| <b>Mounting</b>                                 |                                |              |
| Universal wall / pipe-mount kit                 | MKIT                           | \$122.05     |
| H-mounting bracket (surface mount)              | HBRKT                          | \$69.30      |
| C-mounting bracket (surface mount)              | CBRKT                          | \$49.85      |
| <b>Windows</b>                                  |                                |              |
| Safety glass                                    | SG                             | \$15.00      |
| <b>Dials &amp; scales</b>                       |                                |              |
| Serial number on dial                           | SER#                           | \$5.65       |
| Dial for liquid level measurement               | LL                             | \$64.25      |
| <b>Other</b>                                    |                                |              |
| Clean for O2 service (ASME Level IV)            | O2                             | \$38.45      |
| 3-way manifold block with 4" gauge              | MNFLD                          | \$664.05     |
| Single reed switch 851.3 (1 x SPDT)             | 851.3                          | \$761.55     |
| Dual reed switches 851.33 (2 x SPDT)            | 851.33                         | \$851.50     |
| Single magnetic contact 828.X                   | 828.X                          | \$560.20     |
| Dual magnetic contacts 828.XX                   | 828.XX                         | \$669.45     |
| Single inductive contact 838.X                  | 838.X                          | \$642.65     |
| Dual inductive contacts 838.XX                  | 838.XX                         | \$783.00     |
| 4...20mA output signal for liquid level         | 891.44                         | \$789.40     |
| <b>Other options available</b>                  |                                |              |
| Calibration and material certificates           | <i>Refer to pages 261, 262</i> |              |
| Special scales, logos and other artwork charges | <i>Refer to pages 263, 265</i> |              |
| Needle valves, siphons and other accessories    | <i>Refer to pages 255-259</i>  |              |

Shaded options are non-standard and may require extended lead-times

# DIFFERENTIAL PRESSURE GAUGES

Mechanical Pressure > Differential Gauges 712.25DP

## Differential Pressure Gauges - Dual Bourdon Tube Design

### Standard features

- **Case:** Black epoxy-coated aluminum
- **Wetted parts:** Copper alloy
- **Window:** Flat Glass
- **Window ring:** Black aluminum
- **Dial:** White aluminum
- **Pointer:** Black aluminum
- **Case fill:** None
- **Accuracy:**  $\pm 2/1/2\%$  of span
- **Integral rear flange on case**
- **Datasheet:** 712.25DP

| Type              |                    | 712.25DP          |                   |
|-------------------|--------------------|-------------------|-------------------|
| Size              |                    | 4½"               | 6"                |
| Connection        |                    | LM                |                   |
| Conn. size        |                    | 2 x ¼" NPT        |                   |
| Diff. range       | Max. static press. |                   |                   |
| <b>List price</b> |                    | <b>\$1,396.00</b> | <b>\$1,752.00</b> |
| 15 psid           | 15 psig            |                   |                   |
| 30 psid           | 30 psig            | 4241487           | 4241819           |
| 60 psid           | 60 psig            | 4241495           | 4241827           |
| 100 psid          | 100 psig           | 4241509           | 4241835           |
| 160 psid          | 160 psig           | 4241517           | 4241843           |
| 200 psid          | 200 psig           | 4241525           | 4241851           |
| 300 psid          | 300 psig           |                   |                   |
| 400 psid          | 400 psig           | 4241541           | 4241879           |
| 600 psid          | 600 psig           |                   |                   |
| 800 psid          | 800 psig           |                   |                   |
| 1,000 psid        | 1,000 psig         | 4241568           | 4241895           |
| <b>List price</b> |                    | <b>\$1,396.00</b> | <b>\$1,752.00</b> |
| 15/0/15 psid      | 30 psig            |                   |                   |
| 30/0/30 psid      | 60 psig            |                   |                   |
| 50/0/50 psid      | 100 psig           |                   |                   |
| 100/0/100 psid    | 200 psig           |                   |                   |
| 150/0/150 psid    | 300 psig           |                   |                   |
| 200/0/200 psid    | 400 psig           |                   |                   |
| 400/0/400 psid    | 800 psig           |                   |                   |
| 500/0/500 psid    | 1,000 psig         |                   |                   |



Factory stocked items shown in **bold print**.  
Items without part numbers are available - consult factory.

# DIFFERENTIAL PRESSURE GAUGES

Mechanical Pressure > Differential Gauges > Options for 712.25DP

## Options for type 712.25DP

| Option  | Code                           | 712.25DP<br>4½" | 712.25DP<br>6" |
|---|--------------------------------|-----------------|----------------|
| <b>Connections</b>                              |                                |                 |                |
| 2 x G1/4B                                       | G1/4                           | \$0.00          | \$0.00         |
| <b>Restrictor</b>                               |                                |                 |                |
| Brass, press-in, 0.3mm bore                     | R                              | \$4.00          | \$4.00         |
| Brass, press-in, 0.5mm bore                     | R0.5                           | \$5.00          | \$5.00         |
| <b>Other</b>                                    |                                |                 |                |
| Clean for O2 service (ASME Level IV)            | O2                             | \$38.45         | \$38.45        |
| <b>Other options available</b>                  |                                |                 |                |
| Calibration and material certificates           | <i>Refer to pages 261, 262</i> |                 |                |
| Special scales, logos and other artwork charges | <i>Refer to pages 263, 265</i> |                 |                |
| Needle valves, siphons and other accessories    | <i>Refer to pages 255-259</i>  |                 |                |

Shaded options are non-standard and may require extended lead-times

# DIFFERENTIAL PRESSURE GAUGES

Mechanical Pressure > Differential Gauges > 712.25DX

## Differential Pressure Gauges - Duplex Gauge

### Standard features

- **Case:** Black epoxy-coated aluminum
- **Wetted parts:** Copper alloy
- **Window:** Flat Glass
- **Window ring:** Black aluminum
- **Dial:** White aluminum
- **Pointer:** Black aluminum
- **Case fill:** None
- **Accuracy:**  $\pm 2/1/2\%$  of span
- **Integral rear flange on case**
- **Datasheet:** 712.25DX

| Type        | 712.25DX   |            |
|-------------|------------|------------|
| Size        | 4½"        | 6"         |
| Connection  | LM         |            |
| Conn. size  | 2 x ¼" NPT |            |
| Diff. range |            |            |
| List price  | \$769.00   | \$1,150.00 |
| 15 psi      | 4241657    | 4241738    |
| 30 psi      | 4241665    | 4241746    |
| 60 psi      | 4241673    | 4241754    |
| 100 psi     | 4241681    | 4241762    |
| 160 psi     |            |            |
| 200 psi     |            |            |
| 300 psi     | 4241691    | 4241771    |
| 400 psi     |            |            |
| 600 psi     |            |            |
| 800 psi     |            |            |
| 1,000 psi   | 4241720    | 4241801    |



Factory stocked items shown in **bold print**.  
Items without part numbers are available - consult factory.

# DIFFERENTIAL PRESSURE GAUGES

Mechanical Pressure > Differential Gauges > Options for 712.25DX

## Options for type 712.25DX

| Option  | Code                           | 712.25DX<br>4½" | 712.25DX<br>6" |
|---|--------------------------------|-----------------|----------------|
| <b>Connections</b>                              |                                |                 |                |
| 2 x G1/4B                                       | G1/4                           | \$0.00          | \$0.00         |
| <b>Restrictor</b>                               |                                |                 |                |
| Brass, press-in, 0.3mm bore                     | R                              | \$4.00          | \$4.00         |
| Brass, press-in, 0.5mm bore                     | R0.5                           | \$5.00          | \$5.00         |
| <b>Other</b>                                    |                                |                 |                |
| Clean for O2 service (ASME Level IV)            | O2                             | \$38.45         | \$38.45        |
| <b>Other options available</b>                  |                                |                 |                |
| Calibration and material certificates           | <i>Refer to pages 261, 262</i> |                 |                |
| Special scales, logos and other artwork charges | <i>Refer to pages 263, 265</i> |                 |                |
| Needle valves, siphons and other accessories    | <i>Refer to pages 255-259</i>  |                 |                |

Shaded options are non-standard and may require extended lead-times

# DIFFERENTIAL PRESSURE GAUGES

Mechanical Pressure > Differential Gauges > 732.25, 732.26

## Differential Pressure Gauges - High Differential & Static Pressures

### Standard features

- **Case:** Black epoxy-coated aluminum
- **Wetted parts:** 316L SS, Monel® & PTFE
- **Window:** Acrylic
- **Window ring:** SS, polished
- **Dial:** White aluminum - 732.25  
Black aluminum - 732.26
- **Pointer:** Aluminum, adjustable
- **Case fill:** None - 732.25/732.26  
Glycerine - 733.25/733.26
- **Accuracy:** ±1% of span
- **Datasheet:** 732.25 or 732.26

| Type                   | 732.25                  |                   | 732.26                        |                   |
|------------------------|-------------------------|-------------------|-------------------------------|-------------------|
|                        | 4½"                     | 6"                | 4½"                           | 6"                |
| Size                   |                         |                   |                               |                   |
| Conn. size             | 2 x ¼" NPT Female, Back |                   | 2 x ¼" NPT Female, Top/Bottom |                   |
| List price             | <b>\$1,924.00</b>       | <b>\$1,924.00</b> | <b>\$1,802.00</b>             | <b>\$1,802.00</b> |
| 100" H <sub>2</sub> Od |                         |                   | 4375986                       | <b>4374246</b>    |
| 150" H <sub>2</sub> Od |                         |                   | 4375994                       | 4376036           |
| 200" H <sub>2</sub> Od |                         |                   | 4376001                       | 4376044           |
| 300" H <sub>2</sub> Od |                         |                   | 4376019                       | 4376052           |
| 400" H <sub>2</sub> Od |                         |                   | 4376027                       | 4376060           |
| 15 psid                | 4375862                 | 4375926           |                               |                   |
| 30 psid                | 4375870                 | 4375935           |                               |                   |
| 60 psid                | 4375888                 | 4375943           |                               |                   |
| 100 psid               | 4375896                 | 4375951           |                               |                   |
| 230 psid               | 4375900                 | 4375969           |                               |                   |
| 300 psid               | 4375918                 | 4375977           |                               |                   |
| 400 psid               |                         |                   |                               |                   |
| 500 psid               |                         |                   |                               |                   |
| 600 psid               |                         |                   | N/A                           | N/A               |

Factory stocked items shown in **bold print**.

Items without part numbers are available - consult factory.



732.25



732.26



# DIFFERENTIAL PRESSURE GAUGES

Mechanical Pressure > Differential Gauges > Options for 732.25, 732.26

## Options for type 732.25, 732.26

| Option   | Code                    | 732.25<br>4½" | 732.25<br>6" | 732.26<br>4½" | 732.26<br>6" |
|--|-------------------------|---------------|--------------|---------------|--------------|
| <b>Case / ring options</b>   |                         |               |              |               |              |
| 304 SS case  | SS CASE                 | \$54.20       | \$206.75     | \$54.20       | \$206.75     |
| <b>Case liquid fills</b>   |                         |               |              |               |              |
| Glycerine  | 733.25 / 733.26         | \$58.50       | \$58.50      | \$58.50       | \$58.50      |
| Glycerine / water (86.5 / 13.5)  | GLY86.5                 | \$58.50       | \$58.50      | \$58.50       | \$58.50      |
| Silicone 1,000 cst   | SIL1000                 | \$68.50       | \$68.50      | \$68.50       | \$68.50      |
| Silicone 50 cst  | SIL50                   | \$68.50       | \$68.50      | \$68.50       | \$68.50      |
| Silicone 350 cst   | SIL 350                 | \$68.50       | \$68.50      | \$68.50       | \$68.50      |
| <b>Connections</b>   |                         |               |              |               |              |
| 2 x G1/4B female   | G1/4                    | \$0.00        | \$0.00       | \$0.00        | \$0.00       |
| 2 x 1/2" NPT female  | 1/2                     | \$29.35       | \$29.35      | \$29.35       | \$29.35      |
| 2 x G1/2B female   | G1/2                    | \$29.35       | \$29.35      | \$29.35       | \$29.35      |
| <b>Mounting</b>  |                         |               |              |               |              |
| Wall / pipe-mount kit  | MKIT                    | n/a           | n/a          | \$160.95      | \$160.95     |
| H-mounting bracket   | HBRKT                   | n/a           | n/a          | \$143.50      | \$143.50     |
| C-mounting bracket   | CBRKT                   | n/a           | n/a          | \$34.45       | \$34.45      |
| <b>Windows</b>   |                         |               |              |               |              |
| Safety glass   | SG                      | \$11.00       | \$15.00      | \$11.00       | \$15.00      |
| <b>Dials &amp; scales</b>  |                         |               |              |               |              |
| Serial number on dial  | SER#                    | \$5.65        | \$5.65       | \$5.65        | \$5.65       |
| Square root dial for flow  | SQ RT                   | \$132.80      | \$132.80     | n/a           | n/a          |
| Dial for liquid level measurement  | LL                      | n/a           | n/a          | \$54.20       | \$54.20      |
| <b>Other</b>   |                         |               |              |               |              |
| Clean for O2 service (ASME Level IV)   | O2                      | \$38.45       | \$38.45      | \$38.45       | \$38.45      |
| NACE compliance, MR0175 latest edition.<br>For 316L SS wetted parts; includes *NACE SOUR<br>GAS SERVICE* printed on dial | NACE                    | \$24.00       | \$24.00      | \$24.00       | \$24.00      |
| <b>Other options available</b>   |                         |               |              |               |              |
| Calibration and material certificates  | Refer to pages 261, 262 |               |              |               |              |
| Special scales, logos and other artwork charges  | Refer to pages 263, 265 |               |              |               |              |
| Needle valves, siphons and other accessories   | Refer to pages 255-259  |               |              |               |              |

Shaded options are non-standard and may require extended lead-times

# HIGH PRECISION GAUGES

Mechanical Pressure > High Precision Gauges > 312.20, 332.30

## High Precision Gauges - 6" Test Gauge

### Standard features

- **Case:** 304 SS - 312.20  
304 SS, solid front - 332.30
- **Wetted parts:** Copper alloy - 312.20  
316L SS - 332.30
- **Window:** Safety glass
- **Window ring:** SS, bayonet
- **Dial:** White aluminum - mirrored band
- **Pointer:** Black aluminum, knife-edge, adjustable
- **Case fill:** None
- **Accuracy:**  $\pm 0.25\%$  of span
- **Datasheet:** 312.20 or 332.30

| Type                     | 312.20   |                 | 332.30            |
|--------------------------|--|-----------------|-------------------|
| Size                     | 6"   |                 | 6"                |
| Connection               | LM  |                 |                   |
| Conn. size               | ¼" NPT   | ½" NPT          | ½" NPT            |
| Press scale <sup>1</sup> | PSI  | PSI             | PSI               |
| <b>List price</b>        | <b>\$766.00</b>  | <b>\$766.00</b> | <b>\$1,686.00</b> |
| 30" Hg                   | 9746859  | 9747163         |                   |
| 30"-0-15 psi             |  |                 |                   |
| 30"-0-30 psi             |  |                 |                   |
| 30"-0-60 psi             |  |                 |                   |
| 30"-0-100 psi            |  |                 |                   |
| 30"-0-160 psi            |  |                 |                   |
| 30"-0-200 psi            | 9651454  |                 |                   |
| <b>List price</b>        | <b>\$572.00</b>  | <b>\$572.00</b> | <b>\$1,529.00</b> |
| 10 psi                   |  |                 | 4304713           |
| 15 psi                   | 9746867  | 9747171         |                   |
| 30 psi                   | 9746875  | 9747189         |                   |
| 60 psi                   | 9746884  | 9747197         |                   |
| 100 psi                  | 9746892  | 9747201         | 4207408           |
| 160 psi                  | 9746905  | 9747219         | 4207416           |
| 200 psi                  | 9746914  | 9747227         |                   |
| 300 psi                  | 9746922  | 9747235         | 4248946           |
| 400 psi                  | 9746930  | 9747244         | 50046128          |
| 600 psi                  | 9746948  | 9747252         | 4286112           |
| 800 psi                  | 7938854  | 9747260         |                   |
| 1,000 psi                | 9746965  | 9747278         | 50179691          |
| <b>List price</b>        | <b>\$652.00</b>  | <b>\$652.00</b> | <b>\$1,689.00</b> |
| 1,500 psi                | 9746973  | 9747286         | 50046136          |
| 2,000 psi                | 9746981  | 9747295         |                   |
| 3,000 psi                | 9746999  | 9747308         | 4282559           |
| 5,000 psi                | 9747006  | 9747316         | 9744309           |
| 10,000 psi               | 9747015  | 9747325         |                   |



<sup>1</sup>Vacuum scale: 30" Hg outside in black; 760 mm Hg inside in red.

Factory stocked items shown in **bold print**.  
Items without part numbers are available - consult factory.

# HIGH PRECISION GAUGES

Mechanical Pressure > High Precision Gauges > Options for 312.20, 332.30

## Options for type 312.20, 332.30

| Option  | Code                           | 312.20<br>6" | 332.30<br>6" |
|---|--------------------------------|--------------|--------------|
| <b>Connections</b>                              |                                |              |              |
| 1/4" NPT  | 1/4                            | STD          | \$0.00       |
| G1/4B or G1/2B                                  | G1/4 or G1/2                   | \$0.00       | \$0.00       |
| <b>Case liquid fills</b>                        |                                |              |              |
| Glycerine                                       | 333.30                         | n/a          | \$426.40     |
| Silicone 50 cst                                 | SIL                            | n/a          | \$426.40     |
| <b>Mounting</b>                                 |                                |              |              |
| Front flange, polished SS                       | FF                             | \$91.30      | \$91.30      |
| Rear flange, SS                                 | RF                             | \$78.85      | \$78.85      |
| <b>Pointers</b>                                 |                                |              |              |
| Red mark pointer                                | MP                             | \$102.45     | \$102.45     |
| <b>Restrictors</b>                              |                                |              |              |
| Brass, press-in, 0.3mm bore                     | R                              | \$4.00       | n/a          |
| SS, M4 thread, 0.6mm bore                       | R                              | \$7.05       | \$7.05       |
| <b>Other</b>                                    |                                |              |              |
| Clean for O2 service (ASME Level IV)            | O2                             | \$20.60      | \$20.60      |
| Calibration with gas                            | CGAS                           | \$98.10      | \$98.10      |
| <b>Other options Available</b>                  |                                |              |              |
| Calibration and material certificates           | <i>Refer to pages 261, 262</i> |              |              |
| Special scales, logos and other artwork charges | <i>Refer to pages 263, 265</i> |              |              |
| Needle valves, siphons and other accessories    | <i>Refer to pages 255-259</i>  |              |              |

Shaded options are non-standard and may require extended lead-times

# HIGH PRECISION GAUGES

Mechanical Pressure > High Precision Gauges > 332.54

## High Precision Gauges - 4" Test Gauge

### Standard features

- **Case:** 304 SS
- **Wetted parts:** 316L SS
- **Window:** Safety glass
- **Window ring:** SS, bayonet
- **Dial:** White aluminum, mirrored band
- **Pointer:** Black aluminum, knife-edge, adjustable
- **Case fill:** None
- **Accuracy:**  $\pm 0.25\%$  of span  
Ranges 600 to 2,000 PSI = 0.5% of span
- **Datasheet:** 332.54

| Type                     | 332.54   |
|--------------------------|--|
| Size                     | <b>4"</b>  |
| Connection               | LM  |
| Conn. size               | 1/4" NPT   |
| Press scale <sup>1</sup> | PSI  |
| <b>List price</b>        | <b>\$242.00</b>  |
| 30" Hg                   | <b>4220013</b>   |
| 30"-0-15 psi             | 4362336  |
| 30"-0-30 psi             | 4255232  |
| 30"-0-60 psi             | 4333781  |
| 30"-0-100 psi            | 4237961  |
| 30"-0-160 psi            | 4213176  |
| 30"-0-200 psi            | 4200741  |
| <b>List price</b>        | <b>\$220.00</b>  |
| 10 psi                   | N/A  |
| 15 psi                   | <b>4220021</b>   |
| 30 psi                   | <b>4220030</b>   |
| 60 psi                   | 4220048  |
| 100 psi                  | <b>4220056</b>   |
| 160 psi                  | 4220064  |
| 200 psi                  | 4220072  |
| 300 psi                  | <b>4220081</b>   |
| 400 psi                  | 4220099  |
| 600 psi                  | 4220102  |
| 800 psi                  |  |
| 1,000 psi                |  |
| <b>List price</b>        | <b>\$220.00</b>  |
| 1,500 psi                | 4246004  |
| 2,000 psi                | 4249250  |
| 3,000 psi                | 4237979  |
| 5,000 psi                | 4243269  |
| 10,000 psi               | 50044796   |



<sup>1</sup>Vacuum scale: 30" Hg outside in black; 760 mm Hg inside in red.

Factory stocked items shown in **bold print**.  
Items without part numbers are available - consult factory.

# HIGH PRECISION GAUGES

Mechanical Pressure > High Precision Gauges > Options for 332.54

## Options for type 332.54

| Option  | Code                           | 332.54<br>4" |
|---|--------------------------------|--------------|
| <b>Connections</b>                              |                                |              |
| 1/2" NPT  | 1/2                            | \$0.00       |
| G1/4B or G1/2B                                  | G1/4 or G1/2                   | \$0.00       |
| <b>Mounting</b>                                 |                                |              |
| Rear flange, SS                                 | RF                             | \$23.75      |
| <b>Restrictors</b>                              |                                |              |
| SS, M4 thread, 0.6mm bore                       | R                              | \$7.05       |
| <b>Other</b>                                    |                                |              |
| Clean for O2 service (ASME Level IV)            | O2                             | \$20.60      |
| <b>Other options available</b>                  |                                |              |
| Calibration and material certificates           | <i>Refer to pages 261, 262</i> |              |
| Special scales, logos and other artwork charges | <i>Refer to pages 263, 265</i> |              |
| Needle valves, siphons and other accessories    | <i>Refer to pages 255-259</i>  |              |

Shaded options are non-standard and may require extended lead-times

# HIGH PRECISION GAUGES

Mechanical Pressure > High Precision Gauges > 332.34

## High Precision Gauges - 4½" Test Gauge

### Standard features

- **Case:** Black thermoplastic, solid-front
- **Wetted parts:** 316L SS
- **Window:** Acrylic
- **Window ring:** Black thermoplastic, threaded
- **Dial:** White aluminum, mirrored band
- **Pointer:** Black aluminum, knife-edge, adjustable
- **Case fill:** None
- **Accuracy:** ±0.25% of span  
Ranges 600 to 2,000 PSI = 0.5% of span
- **Datasheet:** 332.34

|                                |   |
|--------------------------------|---|
| <b>Type</b>                    | <b>332.34</b>   |
| <b>Size</b>                    | <b>4½"</b>  |
| <b>Connection</b>              | <b>LM</b>  |
| <b>Conn. size</b>              | ½" NPT  |
| <b>Press scale<sup>1</sup></b> | PSI   |
| <b>List price</b>              | <b>\$275.00</b>   |
| 30" Hg                         | 4334711   |
| 30"-0-15 psi                   |   |
| 30"-0-30 psi                   |   |
| 30"-0-60 psi                   |   |
| 30"-0-100 psi                  |   |
| 30"-0-160 psi                  |   |
| 30"-0-200 psi                  |   |
| <b>List price</b>              | <b>\$253.00</b>   |
| 10 psi                         | N/A   |
| 15 psi                         | 4334770   |
| 30 psi                         | 4334788   |
| 60 psi                         | 4334796   |
| 100 psi                        | 4334800   |
| 160 psi                        | 4334818   |
| 200 psi                        | 4334826   |
| 300 psi                        | 4334834   |
| 400 psi                        | 4334842   |
| 600 psi                        | 4334851   |
| 800 psi                        |   |
| 1,000 psi                      |   |
| <b>List price</b>              | <b>\$253.00</b>   |
| 1,500 psi                      |   |
| 2,000 psi                      | 4394506   |
| 3,000 psi                      | 4200627   |
| 5,000 psi                      | 50008880  |
| 10,000 psi                     | 4200792   |
| <b>List price</b>              | <b>\$310.00</b>   |
| 15,000 psi                     |   |
| 20,000 psi                     |   |



<sup>1</sup>Vacuum scale: 30" Hg outside in black; 760 mm Hg inside in red.

Factory stocked items shown in **bold print**.  
Items without part numbers are available - consult factory.

# HIGH PRECISION GAUGES

Mechanical Pressure > High Precision Gauges > Options for 332.34

## Options for type 332.34

| Option  | Code                           | 332.34<br>4½" |
|---|--------------------------------|---------------|
| <b>Connections</b>                              |                                |               |
| 1/4" NPT  | 1/4                            | \$0.00        |
| G1/4B or G1/2B                                  | G1/4 or G1/2                   | \$0.00        |
| <b>Mounting</b>                                 |                                |               |
| 4½" panel mount kit                             | PM                             | \$141.40      |
| <b>Windows</b>                                  |                                |               |
| Polycarbonate                                   | PC                             | \$4.00        |
| Flat glass                                      | GLS                            | \$14.80       |
| Safety glass                                    | SG                             | \$23.45       |
| <b>Restrictors</b>                              |                                |               |
| SS, M4 thread, 0.6mm bore                       | R                              | \$7.05        |
| <b>Other</b>                                    |                                |               |
| Clean for O2 service (ASME Level IV)            | O2                             | \$20.60       |
| <b>Other options available</b>                  |                                |               |
| Calibration and material certificates           | <i>Refer to pages 261, 262</i> |               |
| Special scales, logos and other artwork charges | <i>Refer to pages 263, 265</i> |               |
| Needle valves, siphons and other accessories    | <i>Refer to pages 255-259</i>  |               |

Shaded options are non-standard and may require extended lead-times

# HIGH PRECISION GAUGES

Mechanical Pressure > High Precision Gauges > 332.25

## High Precision Gauges - Hinged Ring

### Standard features

- **Case:** Black aluminum
- **Wetted parts:** 316L SS
- **Window:** Flat glass
- **Window ring:** Black painted steel
- **Dial:** White aluminum, mirrored band
- **Pointer:** Black aluminum, knife-edge, adjustable
- **Case fill:** None
- **Accuracy:**  $\pm 0.25\%$  of span  
Ranges 600 to 2,000 PSI = 0.5% of span
- **Datasheet:** 332.25

| Type                     | 332.25  |                 |
|--------------------------|---|-----------------|
| Size                     | 4½"   |                 |
| Connection               | LBM  |                 |
| Conn. size               | ¼" NPT  | ½" NPT          |
| Press scale <sup>1</sup> | PSI   | PSI             |
| List price               | <b>\$507.00</b>   | <b>\$507.00</b> |
| 30" Hg                   | 50675567  | 50675818        |
| 30"-0-15 psi             | 50663003  | 50675826        |
| 30"-0-30 psi             | 50675583  | 50675834        |
| 30"-0-60 psi             | 50675591  | 50675842        |
| 30"-0-100 psi            | 50675605  | 50675851        |
| 30"-0-160 psi            | 50675613  | 50675869        |
| 30"-0-200 psi            | 50675621  | 50675877        |
| List price               | <b>\$485.00</b>   | <b>\$485.00</b> |
| 10 psi                   |   |                 |
| 15 psi                   | 50675621  | 50675885        |
| 30 psi                   | 50675648  | 50675893        |
| 60 psi                   | 50675656  | 50675907        |
| 100 psi                  | 50675664  | 50675915        |
| 160 psi                  | 50663011  | 50675923        |
| 200 psi                  | 50663020  | 50675931        |
| 300 psi                  | 50675699  | 50675940        |
| 400 psi                  | 50663038  | 50675958        |
| 600 psi                  | 50663046  | 50675966        |
| 800 psi                  | 50675729  | 50675974        |
| 1,000 psi                | 50675737  | 50675982        |
| List price               | <b>\$527.00</b>   | <b>\$527.00</b> |
| 1,500 psi                | 50675745  | 50675991        |
| 2,000 psi                | 50675753  | 50676008        |
| 3,000 psi                | 50675761  | 50676016        |
| 5,000 psi                | 50675770  | 50676024        |
| 10,000 psi               | 50675788  | 50676032        |
| List price               | <b>\$725.00</b>   | <b>\$725.00</b> |
| 15,000 psi               | 50675796  | 50676041        |
| 20,000 psi               | 50675800  | 50676059        |

<sup>1</sup>Vacuum scale: 30" Hg outside in black; 760 mm Hg inside in red.

Factory stocked items shown in **bold print**.  
Items without part numbers are available - consult factory.





# HIGH PRECISION GAUGES

Mechanical Pressure > High Precision Gauges > Options for 332.25

## Options for type 332.25

| Option  | Code                           | 332.25<br>4½"  |
|---|--------------------------------|----------------|
| <b>Connections</b>                              |                                |                |
| G1/4B or G1/2B                                  | G1/4 or G1/2                   | <b>\$0.00</b>  |
| <b>Restrictors</b>                              |                                |                |
| SS, M4 thread, 0.6mm bore                       | R                              | <b>\$7.05</b>  |
| <b>Other</b>                                    |                                |                |
| Clean for O2 service (ASME Level IV)            | O2                             | <b>\$20.60</b> |
| <b>Other options available</b>                  |                                |                |
| Calibration and material certificates           | <i>Refer to pages 261, 262</i> |                |
| Special scales, logos and other artwork charges | <i>Refer to pages 263, 265</i> |                |
| Needle valves, siphons and other accessories    | <i>Refer to pages 255-259</i>  |                |

Shaded options are non-standard and may require extended lead-times

# HIGH PRECISION GAUGES

Mechanical Pressure > High Precision Gauges > 332.34DD

## High Precision Gauges - Direct Drive

### Standard features

- **Case:** Black thermoplastic, solid-front
- **Wetted parts:** Inconel® X-750 and 316 SS
- **Window:** Polycarbonate
- **Window ring:** Stainless steel
- **Dial:** White aluminum, mirrored band
- **Pointer:** Black aluminum - knife edge - adjustable
- **Case fill:** None
- **Accuracy:**  $\pm 0.25\%$  of span
- **Datasheet:** 332.34DD

| Type                     | 332.34DD   |
|--------------------------|--|
| Size                     | 4½"  |
| Connection               | LM  |
| Conn. size               | ½" NPT   |
| Press scale <sup>1</sup> | PSI  |
| <b>List price</b>        | <b>\$672.00</b>  |
| 30"-0-30 psi             | 52049418   |
| 30"-0-60 psi             | 52049426   |
| 30"-0-150 psi            | 52049434   |
| 30"-0-300 psi            | 52049442   |
| <b>List price</b>        | <b>\$672.00</b>  |
| 30 psi                   | 52049451   |
| 60 psi                   | 52049469   |
| 100 psi                  | 52049477   |
| 160 psi                  | 52049485   |
| 200 psi                  | 52049493   |
| 300 psi                  | 52049507   |
| 500 psi                  | 52049515   |
| 1,000 psi                | 52049523   |
| 1,500 psi                | 52049531   |
| 2,000 psi                | 52049540   |
| 3,000 psi                | 52049558   |
| 5,000 psi                | 52049566   |
| 10,000 psi               | 52049574   |



<sup>1</sup>Vacuum scale: 30" Hg outside in black; 760 mm Hg inside in red.

Factory stocked items shown in **bold print**.

Items without part numbers are available - consult factory.

# HIGH PRECISION GAUGES

Mechanical Pressure > High Precision Gauges > Options for 332.34DD

## Options for type 332.34DD

| Option   | Code                           | 332.34DD<br>4½" LM |
|--|--------------------------------|--------------------|
| <b>Case</b>  |                                |                    |
| Yellow thermoplastic   | BLK CS                         | \$0.00             |
| <b>Connections</b>   |                                |                    |
| G1/4B or G1/2B   | G1/4 or G1/2                   | Call factory       |
| 3/8" NPT or G3/8B  | 3/8 or G3/8                    | Call factory       |
| 9-16-18 UNF F250C female autoclave                               | F250C                          | \$196.60           |
| Teflon® tape on connection                                       | TT                             | \$1.45             |
| <b>Windows</b>   |                                |                    |
| Safety glass (without zero adjustment)                           | SG                             | \$78.55            |
| <b>Dials &amp; scales</b>  |                                |                    |
| Serial number on dial  | SER#                           | \$5.65             |
| Receiver scales (3-15 PSI)                                       | REC                            | \$35.85            |
| <b>Other</b>   |                                |                    |
| Clean for O2 service (ASME Level IV)                             | O2                             | \$156.65           |
| Viton® isolator (not for gas for vacuum service)                 | ISOL                           | \$111.60           |
| EPDM isolator (not for gas for vacuum service)                   | ISOL                           | \$111.60           |
| Porous filter (25-50 micron) <i>one included with each gauge</i> | FLT 25                         | \$30.00            |
| Porous filter (50-100 micron)                                    | FLT 100                        | \$53.55            |
| <b>Other options available</b>                                   |                                |                    |
| Calibration and material certificates                            | <i>Refer to pages 261, 262</i> |                    |
| Special scales, logos and other artwork charges                  | <i>Refer to pages 263, 265</i> |                    |
| Needle valves, siphons and other accessories                     | <i>Refer to pages 255-259</i>  |                    |

<sup>1</sup> Vacuum scale: 30" Hg outside in black; 760 mm Hg inside in red.

Shaded options are non-standard and may require extended lead-times

# HIGH PRECISION GAUGES

Mechanical Pressure > High Precision Gauges > 342.11

## High Precision Gauges - 10" Precision Test Gauges

### Standard features

- **Case:** Cast aluminum, dark grey
- **Wetted parts:** Ni-Span C & 316L SS
- **Window:** Green-tinted acrylic, non-reflective
- **Window ring:** Cast aluminum, dark grey
- **Dial:** White aluminum, mirrored band
- **Pointer:** Aluminum, knife-edge, adjustable
- **Case fill:** None
- **Accuracy:**  $\pm 0.10\%$  of span
- **Datasheet:** 342.11

| Type                     | 342.11   |
|--------------------------|--|
| Size                     | 10"  |
| Connection               | LM  |
| Conn. size               | 1/4" NPT Female  |
| Press scale <sup>1</sup> | PSI  |
| <b>List price</b>        | <b>\$2,475.00</b>  |
| 30" Hg                   | 9328750  |
| 30"-0-15 psi             | 9328769  |
| 30"-0-30 psi             | 9328777  |
| 30"-0-60 psi             | 9328785  |
| 30"-0-100 psi            | 9328793  |
| 30"-0-150 psi            | 8988927  |
| 30"-0-200 psi            |  |
| <b>List price</b>        | <b>\$2,475.00</b>  |
| 10 psi                   |  |
| 15 psi                   | 9328823  |
| 30 psi                   | 9328831  |
| <b>List price</b>        | <b>\$2,169.00</b>  |
| 60 psi                   | 9328840  |
| 100 psi                  | 9328858  |
| 160 psi                  | 9328866  |
| 200 psi                  | 9328874  |
| 300 psi                  | 9328882  |
| 400 psi                  | 9328890  |
| 600 psi                  | 9328904  |
| 800 psi                  | 8988854  |
| <b>List price</b>        | <b>\$2,292.00</b>  |
| 1,000 psi                | 9328920  |
| 1,500 psi                |  |
| 2,000 psi                | 9328947  |
| 3,000 psi                | 9328955  |
| 5,000 psi                |  |
| 10,000 psi               |  |
| <b>List price</b>        | <b>\$2,816.00</b>  |
| 15,000 psi               | 9328998  |
| 20,000 psi               | 9329005  |
| <b>List price</b>        | <b>\$2,500.00</b>  |
| 300" H <sub>2</sub> O    | 8590931  |
| 400" H <sub>2</sub> O    |  |
| 600" H <sub>2</sub> O    |  |
| 1,000" H <sub>2</sub> O  |  |



<sup>1</sup>Vacuum scale: 30" Hg outside in black; 760 mm Hg inside in red.

Factory stocked items shown in **bold print**.  
Items without part numbers are available - consult factory.

# HIGH PRECISION GAUGES

Mechanical Pressure > High Precision Gauges > Options for 342.11

## Options for type 342.11

| Option   | Code                           | 342.11<br>10" |
|--|--------------------------------|---------------|
| <b>Connections</b>                                 |                                |               |
| 1/2" NPT male                                      | 1/2                            | \$79.25       |
| G1/4B or G1/2B male                                | G1/4 or G1/2                   | \$79.25       |
| <b>Mounting</b>                                    |                                |               |
| Rear flange, black aluminum                        | RF                             | \$218.50      |
| Bracket for panel mounting, black steel            | Standard                       | N/C           |
| <b>Windows</b>                                     |                                |               |
| Safety glass                                       | SG                             | \$187.45      |
| <b>Other</b>                                       |                                |               |
| Clean for O2 service (ASME Level IV)               | O2                             | \$347.05      |
| Calibration with gas (400 to 5000 psi ranges only) | GAS                            | \$212.05      |
| Replacement carry case                             |                                | \$215.30      |
| Custom scale or dial                               |                                | \$578.40      |
| <b>Other options available</b>                     |                                |               |
| Calibration and material certificates              | <i>Refer to pages 261, 262</i> |               |
| Special scales, logos and other artwork charges    | <i>Refer to pages 263, 265</i> |               |
| Needle valves, siphons and other accessories       | <i>Refer to pages 255-259</i>  |               |

Shaded options are non-standard and may require extended lead-times

# CALIBRATION EQUIPMENT

Mechanical Pressure > Calibration Equipment > CPG 1000

## Calibration Equipment - Digital Test Gauges

### Standard features

- **Case:** SS, meets NEMA 4, IP 65
- **Wetted parts:** 316L SS
- **Accuracy:** ±0.05% of span
- **Rubber boot standard on all LM units**
- **Datasheet:** CPG 1000



| Type              | CPG 1000          |                   |                            |                                   |                               |
|-------------------|-------------------|-------------------|----------------------------|-----------------------------------|-------------------------------|
| Size              | 4"                |                   |                            |                                   |                               |
| Connection        | LM or LBM         |                   |                            |                                   |                               |
| Conn. size        | ¼" NPT            |                   |                            |                                   |                               |
| Configuration     | Lower mount       | Lower back mount  | LM w/ opt. 24 V ext. power | LBM style w/ opt. 24 V ext. power | Kit w/ pump, test hose & case |
| <b>List price</b> | <b>\$966.00</b>   | <b>\$1,030.00</b> | <b>\$1,030.00</b>          | <b>\$1,068.00</b>                 |                               |
| 10" W.C.          | 52189074          | N/A               | N/A                        | N/A                               | N/A                           |
| 30" W.C.          | 50577930          | 50578367          | 50578529                   | 50578669                          | N/A                           |
| <b>List price</b> | <b>\$852.00</b>   | <b>\$899.00</b>   | <b>\$921.00</b>            | <b>\$954.00</b>                   | <b>\$2,100.00</b>             |
| -15-0-15 psi      | 50577964          | 50578405          | 50578553                   | 50579304                          | 50579428                      |
| -15-0-30 psi      | 50577972          | 50578421          | 50578561                   | 50579312                          | 50579436                      |
| 15 psi            | 50577948          | 50578383          | 50578537                   | 50579282                          | 50579401                      |
| 30 psi            | 50577956          | 50578391          | 50578545                   | 50579291                          | 50579410                      |
| 100 psi           | 50577981          | 50578448          | 50578570                   | 50579321                          | 50579444                      |
| 300 psi           | 50577999          | 50578456          | 50578596                   | 50579339                          | 50579452                      |
| 500 psi           | 50578006          | 50578464          | 50578600                   | 50579347                          | 50579461                      |
| <b>List price</b> | <b>\$852.00</b>   | <b>\$899.00</b>   | <b>\$921.00</b>            | <b>\$852.00</b>                   | <b>\$2,100.00</b>             |
| 1,000 psi         | 50578014          | 50578472          | 50578618                   | 50579355                          | 50579479                      |
| 2,000 psi         | 50578022          | 50578481          | 50578626                   | 50579363                          | 50579487                      |
| 3,000 psi         | 50578341          | 50578499          | 50578634                   | 50579371                          | 50579509                      |
| 5,000 psi         | 50578359          | 50578502          | 50578642                   | 50579380                          | 50579517                      |
| <b>List price</b> | <b>\$938.00</b>   | <b>\$1,000.00</b> | <b>\$1,000.00</b>          | <b>\$1,045.00</b>                 | <b>\$2,339.00</b>             |
| 10,000 psi        | 50578375          | 50578511          | 50578651                   | 50579398                          | 50579495                      |
| <b>List price</b> | <b>\$1,224.00</b> |                   |                            |                                   |                               |
| 15,000 psi        | 52189058          | N/A               | N/A                        | N/A                               | N/A                           |
| <b>List price</b> | <b>\$832.00</b>   | <b>\$899.00</b>   | <b>\$899.00</b>            | <b>\$937.00</b>                   |                               |
| 15 psia           | 50579525          | 50579827          | 50579860                   | 50579908                          | N/A                           |
| 30 psia           | 50579533          | 50579835          | 50579878                   | 50579916                          | N/A                           |
| 100 psia          | 50579541          | 50579843          | 50579886                   | 50579924                          | N/A                           |
| 300 psia          | 50579819          | 50579851          | 50579894                   | 50579935                          | N/A                           |

|                   |                            |
|-------------------|----------------------------|
| <b>List price</b> | <b>\$549.00</b>            |
| 50738631          | CPG 1000 Data Log Software |

Factory stocked items shown in **bold print**.  
Items without part numbers are available - consult factory.

# CALIBRATION EQUIPMENT

Mechanical Pressure > Calibration Equipment > WICP-L100, WICP-M500, WICP-H10K

## Calibration Equipment - Pressure Calibrators

| Type               | WICP-L100         | WICP-M500       | WICP-H10K       |
|--------------------|-------------------|-----------------|-----------------|
|                    | <b>Hand Pumps</b> |                 |                 |
| <b>List price</b>  | <b>\$426.00</b>   | <b>\$636.00</b> | <b>\$932.00</b> |
| -28" Hg to 100 psi | 50578031          | N/A             | N/A             |
| -29" Hg to 600 psi | N/A               | 50578049        | N/A             |
| 0 to 10,000 psi    | N/A               | N/A             | 50578057        |

| Accessories  | Part number | List price        |
|--|-------------|-------------------|
| <b>Pump kits</b> <i>Kits include hard sided carrying case</i>  |             |                   |
| WICP-L100 Kit - Low pressure & vacuum pump (-28 in. Hg to 100 psi) with one test hose and one 1/8" FNPT port | 50578065    | <b>\$540.00</b>   |
| WICP-M500 Kit - High pressure & vacuum pump (-29 In Hg to 500 psi) with one test hose and one 1/4" FNPT port | 50573284    | <b>\$755.00</b>   |
| WICP-H10K Kit - Hydraulic pump (0 to 10,000 psi) with one test hose and one 1/4" FNPT port                   | 50578073    | <b>\$1,215.00</b> |
| <b>Fittings and adapters for pumps</b>   |             |                   |
| Adapter 1/4 F BSP to 1/8 F NPT   | 50578081    | <b>\$17.55</b>    |
| Adapter 1/4 F NPT to 1/4 M BSP   | 50578090    | <b>\$17.55</b>    |
| Adapter 1/4 M NPT to 1/4 F BSP   | 50578103    | <b>\$17.55</b>    |
| Adapter 1/4 M NPT to 1/4 M NPT (Union)   | 50578111    | <b>\$10.70</b>    |
| Connector 1/4 M NPT to quick connect for high pressure hydraulic hose  | 50578120    | <b>\$91.15</b>    |
| Tee, Street, SS, 1/4 F NPT x 1/4 F NPT x 1/4 M NPT   | 50578138    | <b>\$46.10</b>    |
| Adapter 1/8 F NPT to 1/4 F NPT (Union)   | 50578146    | <b>\$17.55</b>    |
| Adapter 1/8 M NPT to 1/4 M BSP   | 50578154    | <b>\$17.55</b>    |
| Adapter 1/8 M NPT to 1/4 M NPT   | 50578162    | <b>\$17.55</b>    |
| Connector 1/8 M NPT to 1/8 quick connect tubing (nylon)  | 50578171    | <b>\$10.70</b>    |
| Hose, high pressure with quick connect fittings for WICP-H10K  | 50673262    | <b>\$182.25</b>   |
| PAK100 accessory kit for WICP-L100 includes carrying case, test hose and fittings                            | 50673203    | <b>\$170.00</b>   |
| PAK500 accessory kit for WICP-M500 includes carrying case, test hose and fittings                            | 50673220    | <b>\$170.00</b>   |
| PAK100 accessory kit for WICP-H10K includes carrying case, test hose and fittings                            | 50673246    | <b>\$426.00</b>   |

Factory stocked items shown in **bold print**.  
Items without part numbers are available - consult factory.



WICP-L100  
Pneumatic Pump Kit



WICP-M500  
Pneumatic Pump Kit  
(shown with CPG 1000)



WICP-M500  
Pneumatic Pump Kit  
(shown with CPG 1000)

# CALIBRATION EQUIPMENT

Mechanical Pressure > Calibration Equipment > CPH6600

## Pressure Calibrators

### Standard features

- Integrated electric pump (ranges 30 psi, 150 psi, 300 psi)
- Supplied certified to NIST 0.025% accuracy
- Simultaneous display of pressure, temperature and mA output
- 24V loop power for device under test

| CPH6600    |                    |             |
|------------|--------------------|-------------|
|            | Range              | Part number |
| List price |                    | \$3,045.00  |
|            | -28" Hg to 30 psi  | 50846442    |
| CPH6600    | -28" Hg to 150 psi | 50846451    |
|            | -28" Hg to 300 psi | 50846477    |



CPH-6600



# GENERAL PURPOSE

Electronic Pressure > General Purpose > S-10

## Type S-10 General Purpose Pressure Transmitter

### Standard features

- **Signal output:** 4-20 mA 2-wire
- **Supply voltage:** 10-30 VDC
- **Process connection:** 1/2 NPT male
- **Electrical connection:** DIN EN 175301-803 (DIN 43 650) with plug connector



ELECTRONIC PRESSURE

| Gauge Ranges |                |                 |
|--------------|----------------|-----------------|
| Description  |                |                 |
| Range        | Part #         | Price           |
| 0-50 inWC    | <b>8367656</b> | <b>\$390.50</b> |
| 0-100 inWC   | <b>8341481</b> |                 |
| 0-5 psi      | <b>8415072</b> |                 |
| 0-10 psi     | <b>8642885</b> |                 |
| 0-15 psi     | <b>8643628</b> |                 |
| 0-25 psi     | <b>8341995</b> |                 |
| 0-30 psi     | <b>8643636</b> |                 |
| 0-50 psi     | <b>8348868</b> |                 |
| 0-60 psi     | <b>8643644</b> |                 |
| 0-100 psi    | <b>8643652</b> |                 |
| 0-160 psi    | <b>8341155</b> |                 |
| 0-200 psi    | <b>8644918</b> |                 |
| 0-250 psi    | <b>8341163</b> |                 |
| 0-300 psi    | <b>8341732</b> |                 |
| 0-400 psi    | <b>8341953</b> |                 |
| 0-500 psi    | <b>8341740</b> |                 |
| 0-600 psi    | <b>8347128</b> |                 |
| 0-750 psi    | <b>4294930</b> |                 |
| 0-1,000 psi  | <b>8610007</b> |                 |
| 0-1,500 psi  | <b>8341219</b> |                 |
| 0-2,000 psi  | <b>8353098</b> |                 |
| 0-3,000 psi  | <b>8342275</b> |                 |
| 0-5,000 psi  | <b>8340638</b> |                 |
| 0-8,000 psi  | <b>8341864</b> |                 |
| 0-10,000 psi | <b>8347242</b> |                 |
| 0-15,000 psi | <b>8359143</b> |                 |





































| Vacuum & Compound Ranges |                |                 |
|--------------------------|----------------|-----------------|
| Description              |                |                 |
| Range                    | Part #         | Price           |
| 30"-0 HgVac              | <b>8642850</b> | <b>\$476.55</b> |
| 30"-0-30 psi             | <b>8415080</b> |                 |
| 30"-0-60 psi             | <b>8415099</b> |                 |
| 30"-0-100 psi            | <b>8648646</b> |                 |
| 30"-0-160 psi            | <b>9796881</b> |                 |
| 30"-0-200 psi            | <b>8985538</b> |                 |

| Absolute Pressure Ranges |                |                 |
|--------------------------|----------------|-----------------|
| Description              |                |                 |
| Range                    | Part #         | Price           |
| 0-15 psia                | <b>8587582</b> | <b>\$476.55</b> |
| 0-25 psia                | <b>8358503</b> |                 |
| 0-50 psia                | <b>8347854</b> |                 |
| 0-100 psia               | <b>9734538</b> |                 |
| 0-250 psia               | <b>9734589</b> |                 |
| 0-500 psia               | <b>9767164</b> |                 |

NOTE: Standard items and TRONIC 36 part numbers are shown in **bold print**. (Subject to prior sale)

# GENERAL PURPOSE

























## S-10 Smart Codes for Custom Order Configurations

| Field no. | Code   | Feature  | Base price   | \$390.50   |  |
|-----------|--|--|--|------------|--|
|           |  |  | Additional price   |            |  |
| 1         | <b>Signal output</b>                           |  |  |            |  |
|           | A  | 4... 20 mA, 2-wire                             |    | N/C        |  |
|           | B  | 0... 20 mA, 3-wire                             |  | \$86.05    |  |
|           | F  | 0... 10 V, 3-wire (supply 14-30 V)             |    | \$86.05    |  |
|           | G  | 0... 5 V, 3-wire                               |    | \$86.05    |  |
|           | W  | 0.5 ... 4.5 V 3-wire ratiometric               |    | \$86.05    |  |
|           | ?  | Other - please specify                         |  | on inquiry |  |
| 2         | <b>Unit</b>                                    |  |  |            |  |
|           | P  | psi  |    | N/C        |  |
|           | N  | InWC   |    | N/C        |  |
|           | 3  | psi absolute (from 15 psi to 250 psi absolute) |    | \$86.05    |  |
|           | ?  | Other - please specify                         |  | on inquiry |  |
| 3         | <b>Pressure range</b>                          |  |  |            |  |
|           | CA   | -30 inHg ... 0                                 |    | \$86.05    |  |
|           | CD   | -30 inHg ... 30 psi                            |    | \$86.05    |  |
|           | CF   | -30 inHg ... 60 psi                            |    | \$86.05    |  |
|           | CH   | -30 inHg ... 100 psi                           |    | \$86.05    |  |
|           | CK   | -30 inHg ... 160 psi                           |   | \$86.05    |  |
|           | CL   | -30 inHg ... 200 psi                           |  | \$86.05    |  |
|           | GG   | 0 InWC ... 50 InWC                             |  | N/C        |  |
|           | GU   | 0 InWC ... 100 InWC                            |  | N/C        |  |
|           | CN   | 0 psi ... 5 psi                                |  | N/C        |  |
|           | CP   | 0 psi ... 10 psi                               |  | N/C        |  |
|           | BC   | 0 psi ... 15 psi (0 psi ... 15 psi absolute)   |  | N/C        |  |
|           | CQ   | 0 psi ... 25 psi (0 psi ... 25 psi absolute)   |  | N/C        |  |
|           | BD   | 0 psi ... 30 psi                               |  | N/C        |  |
|           | DA   | 0 psi ... 50 psi (0 psi ... 50 psi absolute)   |  | N/C        |  |
|           | BE   | 0 psi ... 60 psi                               |  | N/C        |  |
|           | BF   | 0 psi ... 100 psi (0 psi ... 100 psi absolute) |  | N/C        |  |
|           | BG   | 0 psi ... 160 psi                              |  | N/C        |  |
|           | BH   | 0 psi ... 200 psi                              |  | N/C        |  |
|           | DG   | 0 psi ... 250 psi (0 psi ... 250 psi absolute) |  | N/C        |  |
|           | BI   | 0 psi ... 300 psi                              |  | N/C        |  |
|           | BK   | 0 psi ... 400 psi                              |  | N/C        |  |
|           | DI   | 0 psi ... 500 psi                              |  | N/C        |  |
|           | BL   | 0 psi ... 600 psi                              |  | N/C        |  |
|           | DJ   | 0 psi ... 750 psi                              |  | N/C        |  |
|           | BN   | 0 psi ... 1,000 psi                            |  | N/C        |  |
|           | BO   | 0 psi ... 1,500 psi                            |  | N/C        |  |
|           | BP   | 0 psi ... 2,000 psi                            |  | N/C        |  |
|           | BQ   | 0 psi ... 3,000 psi                            |  | N/C        |  |
|           | BS   | 0 psi ... 5,000 psi                            |  | N/C        |  |
|           | DS   | 0 psi ... 8,000 psi                            |  | N/C        |  |
| BT        | 0 psi ... 10,000 psi                           |  | N/C  |            |  |
| BU        | 0 psi ... 15,000 psi                           |  | N/C  |            |  |
| ??        | Other - up to maximum specified pressure range |  | on inquiry   |            |  |

# GENERAL PURPOSE

Electronic Pressure > General Purpose > S-10

## S-10 Smart Codes for Custom Order Configurations (continued)





| Field no. | Code | Feature   | Additional price |
|-----------|------|---|------------------|
|           |      | <b>Process connection</b>   |                  |
|           | NB   | 1/4" NPT    | N/C              |
|           | ND   | 1/2" NPT    | N/C              |
|           | NH   | 1/8" NPT    | N/C              |
|           | GB   | G 1/4 B   | N/C              |
|           | GD   | G 1/2 B   | N/C              |
|           | NP   | 1/4" NPT female   | \$63.55          |
|           | NQ   | 1/2" NPT female   | \$63.55          |
|           | NR   | 1/8" NPT female   | \$63.55          |
|           | UA   | 7/16-20 UNF SAE #4 J514 male    | \$63.55          |
|           | UB   | 7/16-20 UNF SAE #4 J514 female                                        | \$63.55          |
|           | UE   | 9/16-18 UNF SAE #6 J514 male    | \$63.55          |
|           | UF   | 9/16-18 UNF SAE #6 J514 female                                        | \$63.55          |
|           | UC   | 3/4-16 UNF SAE #8 J514 male   | \$63.55          |
|           | UD   | 3/4-16 UNF SAE #8 J514 female   | \$63.55          |
|           | CS   | Diaphragm seal  | on inquiry       |
| 4         | ??   | Other - please specify  | on inquiry       |
|           |      | <b>Special design features</b>  |                  |
|           | Z    | Without   | N/C              |
|           | A    | Oxygen, oil and grease free <sup>1)</sup>   | \$99.30          |
| 5         | ?    | Other - please specify  | on inquiry       |
|           |      | <b>Accuracy</b>   |                  |
|           | G    | +/- 0.25% B.F.S.L.    | N/C              |
| 6         | K    | +/- 0.125% B.F.S.L. (≥ 100 inWC)                                    | \$46.35          |
|           |      | <b>Electrical connection</b>  |                  |
|           | A4   | 4 Pin L-plug DIN 43 650 with pg 9 (NEMA 5 / IP 65)                  | N/C              |
|           | AX   | 4 Pin L-plug DIN 43 650 w / 1/2" NPT female conduit (NEMA 5/IP 65)  | \$6.10           |
|           | M5   | M12 x 1, 5 pin circular connector                                   | \$33.10          |
|           | DL   | Cable with free ends (NEMA 4 / IP 67)                               | \$63.55          |
|           | 2X   | 1/2" NPT male conduit with cable                                    | \$63.55          |
|           | XM   | Submersible cable (NEMA 6 / IP 68)  | \$165.50         |
|           | O4   | 4 Pin MIL plug PT02E-8-4P (NEMA 5 / IP 65)                          | \$86.05          |
|           | C6   | 6 Pin MIL plug PT02E-10-6P (NEMA 5 / IP 65)                         | \$86.05          |
| 7         | ??   | Other - please specify  | on inquiry       |
|           |      | <b>Cable length</b>   |                  |
|           | Z    | Without (always with plug connection)                               | N/C              |
|           | Y    | 5 feet    | N/C              |
|           | 1    | 10 feet   | \$13.25          |
|           | 2    | 20 feet   | \$39.75          |
|           | 3    | 30 feet   | \$66.20          |
|           | 4    | 40 feet   | \$92.65          |
|           | 5    | 50 feet   | \$119.15         |
| 8         | ?    | Other - please specify  | on inquiry       |

# GENERAL PURPOSE

Electronic Pressure > General Purpose > S-10

ELECTRONIC PRESSURE

## S-10 Smart Codes for Custom Order Configurations (continued)

| Field no. | Code                               | Feature  | Additional price |
|-----------|------------------------------------|--|------------------|
| 9         | <b>Temperature range of medium</b> |  |                  |
|           | A                                  | -30 ... +100 °C (-22 ... +212 °F)  | N/C              |
|           | B                                  | -40 ... +125 °C (-40 ... +257 °F)  | \$79.40          |
|           | X                                  | Changed because of diaphragm seal attachment (only with process connection CS)                                       | N/C              |
| 10        | <b>Approvals</b>                   |  |                  |
|           | Z                                  | Without                            | N/C              |
|           | G                                  | GL, BV, ABS, RINA, DNV, Class NK   | on inquiry       |
|           | ?                                  | Other - please specify   | on inquiry       |
| 11        | <b>Quality certificates</b>        |  |                  |
|           | Z                                  | Without                            | N/C              |
|           | I                                  | NIST Certificate of Calibration (always with 0.125% accuracy)  | \$72.80          |
|           | ?                                  | Other - please specify   | on inquiry       |
| 12        | <b>Digital display</b>             |  |                  |
|           | Z                                  | Without                            | N/C              |
|           | 1                                  | Digital display (order separately)   | on inquiry       |
| 13        | <b>Additional order details</b>    |  |                  |
|           | Z                                  | Without                          | N/C              |
|           | T                                  | Additional order details   | on inquiry       |

1) Maximum media temperature is -4 ... +140° F (-20 ... +60° C) for pressure ranges 100 InWC to 300 psi. (Field 5, Code A)

TOTAL PRICE

### TRONIC 36 Special Instructions:



If the **TRONIC 36** logo appears next to the selected feature for **all** fields, the transmitter qualifies for shipment within 36 hours as part of the TRONIC 36 program.

Order Code:

**S-10** -  <sup>1</sup> -  <sup>2</sup>  <sup>3</sup> -  <sup>4</sup> -  <sup>5</sup>  <sup>6</sup>  <sup>7</sup>  <sup>8</sup>  <sup>9</sup>  <sup>10</sup> -  <sup>11</sup>  <sup>12</sup>  <sup>13\*</sup>

\*Additional order details \_\_\_\_\_

# GENERAL PURPOSE

Electronic Pressure > General Purpose > S-11

## Type S-11 Flush Diaphragm Pressure Transmitter

### Standard features

- **Signal output:** 4-20 mA 2-wire
- **Supply voltage:** 10-30 VDC
- **Electrical connection:** DIN EN 175301-803 (DIN 43 650) with plug connector
- **Process connection:** G1B or G1/2B depending upon pressure range



ELECTRONIC PRESSURE

| Gauge Ranges            |                |                 |
|-------------------------|----------------|-----------------|
| Description             |                |                 |
| Range                   | Part #         | Price           |
| 0-50 inWC <sup>1</sup>  | <b>9739640</b> | <b>\$456.70</b> |
| 0-100 inWC <sup>1</sup> | <b>8341473</b> |                 |
| 0-5 psi <sup>1</sup>    | <b>4204051</b> |                 |
| 0-10 psi <sup>1</sup>   | <b>8341074</b> |                 |
| 0-15 psi <sup>1</sup>   | <b>8345726</b> |                 |
| 0-25 psi <sup>1</sup>   | <b>8395736</b> |                 |
| 0-30 psi <sup>1</sup>   | 8395746        |                 |
| 0-50 psi                | <b>8395766</b> |                 |
| 0-60 psi                | <b>8351312</b> |                 |
| 0-100 psi               | <b>8341724</b> |                 |
| 0-160 psi               | <b>8643407</b> |                 |
| 0-200 psi               | <b>8641064</b> |                 |
| 0-250 psi               | <b>8341961</b> |                 |
| 0-300 psi               | <b>8341171</b> |                 |
| 0-400 psi               | <b>8342003</b> |                 |
| 0-500 psi               | <b>8341197</b> |                 |
| 0-600 psi               | 8345745        |                 |
| 0-750 psi               | 8352865        |                 |
| 0-1,000 psi             | <b>9777517</b> |                 |
| 0-1,500 psi             | <b>8366706</b> |                 |
| 0-2,000 psi             | 8640823        |                 |
| 0-3,000 psi             | <b>8341758</b> |                 |
| 0-5,000 psi             | <b>8340646</b> |                 |
| 0-8,000 psi             | 9749581        |                 |

| Vacuum & Compound Ranges |                |                 |
|--------------------------|----------------|-----------------|
| Description              |                |                 |
| Range                    | Part #         | Price           |
| 30"-0 HgVac <sup>1</sup> | <b>8395706</b> | <b>\$542.70</b> |
| 30"-0-30 psi             | <b>9796058</b> |                 |
| 30"-0-60 psi             | <b>8345622</b> |                 |
| 30"-0-100 psi            | 8340242        |                 |
| 30"-0-200 psi            | 8342118        |                 |

NOTE: Standard items shown in **bold print**. (Subject to prior sale)

**NOTES:**

<sup>1</sup>Pressure ranges from 50 inWC to 30 PSI are supplied with G1B flush process connections; see datasheet for details

# GENERAL PURPOSE

Electronic Pressure > General Purpose > S-11

ELECTRONIC PRESSURE

## S-11 Smart Codes for Custom Order Configurations

| Field no. | Code | Feature  | Base price       | \$456.70 |
|-----------|------|--|------------------|----------|
|           |      |  | Additional price |          |
|           |      | <b>Signal output</b>                           |                  |          |
|           | A    | 4 ... 20 mA, 2-wire                            | N/C              |          |
|           | B    | 0 ... 20 mA, 3-wire                            | \$86.05          |          |
|           | F    | 0 ... 10 V, 3-wire (Supply 14-30 V)            | \$86.05          |          |
|           | G    | 0 ... 5 V, 3-wire                              | \$86.05          |          |
|           | W    | 0.5 ... 4.5 V 3-wire ratiometric               | \$86.05          |          |
| 1         | ?    | Other - please specify                         | on inquiry       |          |
|           |      | <b>Unit</b>                                    |                  |          |
|           | P    | psi  | N/C              |          |
|           | N    | InWC   | N/C              |          |
|           | 3    | psi absolute (from 15 psi to 250 psi absolute) | \$86.05          |          |
| 2         | ?    | Other - please specify                         | on inquiry       |          |
|           |      | <b>Pressure range</b>                          |                  |          |
|           | CA   | -30 inHg ... 0                                 | \$86.05          |          |
|           | CD   | -30 inHg ... 30 psi                            | \$86.05          |          |
|           | CF   | -30 inHg ... 60 psi                            | \$86.05          |          |
|           | CH   | -30 inHg ... 100 psi                           | \$86.05          |          |
|           | CK   | -30 inHg ... 160 psi                           | \$86.05          |          |
|           | CL   | -30 inHg ... 200 psi                           | \$86.05          |          |
|           | GG   | 0 InWC ... 50 InWC                             | N/C              |          |
|           | GU   | 0 InWC ... 100 InWC                            | N/C              |          |
|           | CN   | 0 psi ... 5 psi                                | N/C              |          |
|           | CP   | 0 psi ... 10 psi                               | N/C              |          |
|           | BC   | 0 psi ... 15 psi (0 psi ... 15 psi absolute)   | N/C              |          |
|           | CQ   | 0 psi ... 25 psi (0 psi ... 25 psi absolute)   | N/C              |          |
|           | BD   | 0 psi ... 30 psi                               | N/C              |          |
|           | DA   | 0 psi ... 50 psi (0 psi ... 50 psi absolute)   | N/C              |          |
|           | BE   | 0 psi ... 60 psi                               | N/C              |          |
|           | BF   | 0 psi ... 100 psi (0 psi ... 100 psi absolute) | N/C              |          |
|           | BG   | 0 psi ... 160 psi                              | N/C              |          |
|           | BH   | 0 psi ... 200 psi                              | N/C              |          |
|           | DG   | 0 psi ... 250 psi (0 psi ... 250 psi absolute) | N/C              |          |
|           | BI   | 0 psi ... 300 psi                              | N/C              |          |
|           | BK   | 0 psi ... 400 psi                              | N/C              |          |
|           | DI   | 0 psi ... 500 psi                              | N/C              |          |
|           | BL   | 0 psi ... 600 psi                              | N/C              |          |
|           | DJ   | 0 psi ... 750 psi                              | N/C              |          |
|           | BN   | 0 psi ... 1,000 psi                            | N/C              |          |
|           | BO   | 0 psi ... 1,500 psi                            | N/C              |          |
| 3         | BP   | 0 psi ... 2,000 psi                            | N/C              |          |

# GENERAL PURPOSE

Electronic Pressure > General Purpose > S-11

## S-11 Smart Codes for Custom Order Configurations (continued)

| Field no. | Code | Feature   | Additional price |
|-----------|------|---|------------------|
|           |      | <b>Pressure range continued</b>                                       |                  |
|           | BQ   | 0 psi ... 3,000 psi   | N/C              |
|           | BS   | 0 psi ... 5,000 psi   | N/C              |
|           | DS   | 0 psi ... 8,000 psi   | N/C              |
| 3         | ??   | Other - please specify  | on inquiry       |
|           |      | <b>Process connection</b>   |                  |
|           | 85   | G 1 B, flush diaphragm with O-ring (up to 25 psi)                     | N/C              |
|           | 86   | G 1/2 B, flush diaphragm with O-ring ( $\geq 30$ psi)                 | N/C              |
| 4         | ??   | Other - please specify  | on inquiry       |
|           |      | <b>Material of wetted parts</b>                                       |                  |
|           | 1    | Stainless steel, NBR O-Ring <sup>1)</sup>                             | N/C              |
|           | L    | Stainless steel, Viton <sup>®</sup> O-Ring                            | \$14.60          |
| 5         | ?    | Other - please specify  | on inquiry       |
|           |      | <b>Special design features</b>  |                  |
|           | Z    | Without   | N/C              |
|           | G    | Suitable for food   | \$59.60          |
|           | A    | Oxygen, oil and grease free <sup>2)</sup>                             | on inquiry       |
| 6         | ?    | Other - please specify  | on inquiry       |
|           |      | <b>Accuracy</b>   |                  |
|           | G    | +/- 0.25% B.F.S.L.  | N/C              |
| 7         | K    | +/- 0.125% B.F.S.L. ( $\geq 100$ inWC)                                | \$46.35          |
|           |      | <b>Electrical connection</b>  |                  |
|           | A4   | 4 Pin L-plug DIN 43 650 with pg 9 (NEMA 5 / IP 65)                    | N/C              |
|           | AX   | 4 Pin L-plug DIN 43 650 with 1/2" NPT female conduit (NEMA 5 / IP 65) | \$6.10           |
|           | DL   | Cable with free gnnds (NEMA 4 / IP 67)                                | \$63.55          |
|           | 2X   | 1/2" male conduit with cable  | \$63.55          |
|           | XM   | Submersible cable (NEMA 6 / IP 68)                                    | \$165.50         |
|           | O4   | 4 Pin MIL Plug PT02E-8-4P (NEMA 5 / IP 65)                            | \$86.05          |
|           | C6   | 6 Pin MIL Plug PT02E-10-6P (NEMA 5 / IP 65)                           | \$86.05          |
| 8         | ??   | Other - please specify  | on inquiry       |
|           |      | <b>Cable length</b>   |                  |
|           | Z    | Without (always with plug connection)                                 | N/C              |
|           | Y    | 5 feet  | N/C              |
|           | 1    | 10 feet   | \$13.25          |
|           | 2    | 20 feet   | \$39.75          |
|           | 3    | 30 feet   | \$66.20          |
|           | 4    | 40 feet   | \$92.65          |
|           | 5    | 50 feet   | \$119.15         |
| 9         | ?    | Other - please specify  | on inquiry       |

# GENERAL PURPOSE

Electronic Pressure > General Purpose > S-11

ELECTRONIC PRESSURE

## S-11 Smart Codes for Custom Order Configurations (continued)

| Field no. | Code | Feature   | Additional price |
|-----------|------|---|------------------|
|           |      | <b>Temperature range of medium</b>                            |                  |
|           | A    | -30 ... +100 °C (-22 ... +212 °F)                             | N/C              |
|           | B    | -40 ... +125 °C (-40 ... +257 °F)                             | \$73.35          |
| <b>10</b> | C    | -20 ... +150 °C (-4 ... +302 °F) with cooling element         | on inquiry       |
|           |      | <b>Approvals</b>  |                  |
|           | Z    | Without   | N/C              |
| <b>11</b> | ?    | Other - please specify  | on inquiry       |
|           |      | <b>Quality certificates</b>                                   |                  |
|           | Z    | Without   | N/C              |
|           | I    | NIST Certificate of Calibration (always with 0.125% accuracy) | \$72.80          |
| <b>12</b> | ?    | Other - please specify  | on inquiry       |
|           |      | <b>Digital display</b>  |                  |
|           | Z    | Without   | N/C              |
| <b>13</b> | 1    | Digital display (order separately)                            | on inquiry       |
|           |      | <b>Additional order details</b>                               |                  |
|           | Z    | Without   | N/C              |
| <b>14</b> | T    | Additional order details                                      | N/C              |

1) Not available with cooling element option (Field 10, Code C)

2) Maximum media temperature is -4 ... +140°F (-20 ... +60°C) for pressure ranges 100 InWC to 500 psi. (Field 6, Code A)

TOTAL PRICE

Order Code:    1    2    3    4    5    6    7    8    9    10    11    12    13    14\*

**S-11** -  -   -  -       -

\*Additional order details \_\_\_\_\_



# GENERAL PURPOSE

Electronic Pressure > General Purpose > F-20

## Type F-20 Pressure Transmitter with NEMA 4X Integral Junction Box

### Standard features

- **Signal output:** 4-20 mA 2-wire
- **Supply voltage:** 10-30 DC
- **Process connection:** 1/2 NPT male
- **Electrical connection:** Field case with 1/2" NPT female conduit



ELECTRONIC PRESSURE

### F-20 Part Numbers

| Gauge Ranges |                 |                 |
|--------------|-----------------|-----------------|
| Description  |                 |                 |
| Range        | Part #          | Price           |
| 0-50 inWC    | <b>12127469</b> | <b>\$549.30</b> |
| 0-100 inWC   | <b>12127477</b> |                 |
| 0-5 psi      | 12127493        |                 |
| 0-10 psi     | <b>12127507</b> |                 |
| 0-15 psi     | <b>12127523</b> |                 |
| 0-25 psi     | <b>12127531</b> |                 |
| 0-30 psi     | 12127540        |                 |
| 0-50 psi     | 12127558        |                 |
| 0-60 psi     | <b>12127566</b> |                 |
| 0-100 psi    | <b>12128873</b> |                 |
| 0-160 psi    | <b>12127574</b> |                 |
| 0-200 psi    | <b>12127582</b> |                 |
| 0-300 psi    | <b>12127591</b> |                 |
| 0-500 psi    | <b>12127639</b> |                 |
| 0-1,000 psi  | <b>12127671</b> |                 |
| 0-2,000 psi  | 12127681        |                 |
| 0-3,000 psi  | 12127699        |                 |
| 0-5,000 psi  | <b>12127701</b> |                 |

| Vacuum & Compound Ranges |                 |                 |
|--------------------------|-----------------|-----------------|
| Description              |                 |                 |
| Range                    | Part #          | Price           |
| 30 inHg vac              | <b>12127400</b> | <b>\$635.40</b> |
| 30 inHg/30 psi           | 12127418        |                 |
| 30 inHg/60 psi           | 12127426        |                 |
| 30 inHg/100 psi          | 12127434        |                 |
| 30 inHg/200 psi          | 12127451        |                 |

NOTE: Standard items shown in **bold print**. (Subject to prior sale)

# GENERAL PURPOSE

Electronic Pressure > General Purpose > F-20

## F-20 Smart Codes for Custom Order Configurations

| Field no. | Code | Feature  | Base price       | \$549.30 |
|-----------|------|--|------------------|----------|
|           |      |  | Additional price |          |
|           |      | <b>Signal output</b>                           |                  |          |
|           | A    | 4 ... 20 mA, 2-wire                            | N/C              |          |
|           | B    | 0 ... 20 mA, 3-wire                            | \$86.05          |          |
|           | F    | 0 ... 10 V, 3-wire (Supply 14-30 V)            | \$86.05          |          |
|           | G    | 0 ... 5 V, 3-wire                              | \$86.05          |          |
| <b>1</b>  | ?    | Other - please specify                         | on inquiry       |          |
|           |      | <b>Unit</b>                                    |                  |          |
|           | P    | psi  | N/C              |          |
|           | N    | InWC   | N/C              |          |
|           | 3    | psi absolute                                   | \$86.05          |          |
| <b>2</b>  | ?    | Other - please specify                         | on inquiry       |          |
|           |      | <b>Pressure range</b>                          |                  |          |
|           | CA   | -30 inHg ... 0                                 | \$86.05          |          |
|           | CD   | -30 inHg ... 30 psi                            | \$86.05          |          |
|           | CF   | -30 inHg ... 60 psi                            | \$86.05          |          |
|           | CH   | -30 inHg ... 100 psi                           | \$86.05          |          |
|           | CK   | -30 inHg ... 160 psi                           | \$86.05          |          |
|           | CL   | -30 inHg ... 200 psi                           | \$86.05          |          |
|           | GG   | 0 InWC ... 50 InWC                             | N/C              |          |
|           | GU   | 0 InWC ... 100 InWC                            | N/C              |          |
|           | CN   | 0 psi ... 5 psi                                | N/C              |          |
|           | CP   | 0 psi ... 10 psi                               | N/C              |          |
|           | BC   | 0 psi ... 15 psi (0 psi ... 15 psi absolute)   | N/C              |          |
|           | CQ   | 0 psi ... 25 psi (0 psi ... 25 psi absolute)   | N/C              |          |
|           | BD   | 0 psi ... 30 psi                               | N/C              |          |
|           | DA   | 0 psi ... 50 psi (0 psi ... 50 psi absolute)   | N/C              |          |
|           | BE   | 0 psi ... 60 psi                               | N/C              |          |
|           | BF   | 0 psi ... 100 psi (0 psi ... 100 psi absolute) | N/C              |          |
|           | BG   | 0 psi ... 160 psi                              | N/C              |          |
|           | BH   | 0 psi ... 200 psi                              | N/C              |          |
|           | DG   | 0 psi ... 250 psi (0 psi ... 250 psi absolute) | N/C              |          |
|           | BI   | 0 psi ... 300 psi                              | N/C              |          |
|           | BK   | 0 psi ... 400 psi                              | N/C              |          |
|           | DI   | 0 psi ... 500 psi                              | N/C              |          |
|           | BL   | 0 psi ... 600 psi                              | N/C              |          |
|           | DJ   | 0 psi ... 750 psi                              | N/C              |          |
|           | BN   | 0 psi ... 1,000 psi                            | N/C              |          |
|           | BO   | 0 psi ... 1,500 psi                            | N/C              |          |
|           | BP   | 0 psi ... 2,000 psi                            | N/C              |          |
|           | BQ   | 0 psi ... 3,000 psi                            | N/C              |          |
|           | BS   | 0 psi ... 5,000 psi                            | N/C              |          |
| <b>3</b>  | DS   | 0 psi ... 8,000 psi                            | N/C              |          |

# GENERAL PURPOSE

Electronic Pressure > General Purpose > F-20

## F-20 Smart Codes for Custom Order Configurations (continued)

Field no. Code Feature

|    |   | Additional price               |
|----|---|--------------------------------|
|    | <b>Pressure range continued</b>                                 |                                |
| 3  | BT 0 psi ... 10,000 psi   | N/C                            |
|    | BU 0 psi ... 15,000 psi   | N/C                            |
|    | ?? Other - please specify                                       | on inquiry                     |
|    | <b>Process connection</b>                                       |                                |
| 4  | ND 1/2" NPT   | N/C                            |
|    | NB 1/4" NPT   | N/C                            |
|    | GD G 1/2 B  | N/C                            |
|    | GB G 1/4 B  | N/C                            |
|    | CS Diaphragm seal   | on inquiry                     |
|    | ?? Other - please specify                                       | on inquiry                     |
|    |   | <b>Special design features</b> |
| 5  | Z Without   | N/C                            |
|    | G Suitable for food   | \$59.60                        |
|    | A Oxygen, oil and grease free <sup>1)</sup>                     | on inquiry                     |
|    | ?? Other - please specify                                       | on inquiry                     |
|    | <b>Accuracy</b>   |                                |
| 6  | G +/- 0.25% B.F.S.L.  | N/C                            |
|    | K +/- 0.125% B.F.S.L.   | \$46.35                        |
|    | <b>Electrical connection</b>                                    |                                |
| 7  | FE 1/2" NPT female conduit (IP67)                               | N/C                            |
|    | FH Nickel plated brass cable gland (IP68)                       | N/C                            |
|    | FC Stainless steel cable gland (IP68)                           | \$39.75                        |
|    | ?? Other - please specify                                       | on inquiry                     |
|    | <b>Temperature range of medium</b>                              |                                |
| 8  | A -30 ... +100 °C (-22 ... +212 °F)                             | N/C                            |
|    | B -40 ... +125 °C (-40 ... +257 °F)                             | \$79.40                        |
|    | X Changed because of diaphragm seal attachment                  | on inquiry                     |
|    | <b>Quality certificates</b>                                     |                                |
| 9  | Z Without   | N/C                            |
|    | I NIST Certificate of Calibration (always with 0.125% accuracy) | \$72.80                        |
|    | <b>Digital display</b>  |                                |
| 10 | Z Without   | N/C                            |
|    | 1 Digital display (order separately)                            | on inquiry                     |
|    | <b>Additional order details</b>                                 |                                |
| 11 | Z Without   | N/C                            |
|    | T Additional order details                                      | on inquiry                     |

1) Maximum media temperature is -4 ... +140°F (-20 ... +60°C) for pressure ranges 100 InWC to 300 psi.

Order Code:

1 2 3 4 5 6 7 8 9 10 11\* TOTAL PRICE

**F-20** -  -   -  -     -

\*Additional order details \_\_\_\_\_

ELECTRONIC PRESSURE

# GENERAL PURPOSE

Electronic Pressure > General Purpose > F-21

## Type F-21 Flush Diaphragm Pressure Transmitter with NEMA 4X Integral Junction Box

ELECTRONIC PRESSURE

### Standard features

- **Signal output:** 4-20 mA 2-wire
- **Supply voltage:** 10-30 DC
- **Process connection:** G1/2B or G1B flush diaphragm depending upon pressure range
- **Electrical connection:** Field case with 1/2" NPT female conduit



### F-21 Part Numbers

| Gauge Ranges           |                 |                 |
|------------------------|-----------------|-----------------|
| Description            |                 |                 |
| Range                  | Part #          | Price           |
| 0-50 inWC <sup>1</sup> | 12126331        | <b>\$615.55</b> |
| 0-5 psi <sup>1</sup>   | 12127728        |                 |
| 0-10 psi <sup>1</sup>  | 12127736        |                 |
| 0-100 psi              | <b>12127744</b> |                 |

#### NOTES:

<sup>1</sup>Pressure ranges from 50 inWC to 15 psi are supplied with G1B flush process connections; see datasheet for details

NOTE: Standard items shown in **bold print**. (Subject to prior sale)

# GENERAL PURPOSE

Electronic Pressure > General Purpose > F-21

| F-21 Smart Codes for Custom Order Configurations |                        |  | Base price       | \$615.55 |
|--|------------------------|--|------------------|----------|
| Field no.  | Code                   | Feature  | Additional price |          |
| 1  | <b>Signal output</b>   |  |                  |          |
|  | A                      | 4 ... 20 mA, 2-wire                            | N/C              |          |
|  | B                      | 0 ... 20 mA, 3-wire                            | \$86.05          |          |
|  | F                      | 0 ... 10 V, 3-wire (Supply 14-30 V)            | \$86.05          |          |
|  | G                      | 0 ... 5 V, 3-wire                              | \$86.05          |          |
|  | ?                      | Other - please specify                         | on inquiry       |          |
| 2  | <b>Unit</b>            |  |                  |          |
|  | P                      | psi  | N/C              |          |
|  | N                      | InWC   | N/C              |          |
|  | 3                      | psi absolute                                   | \$86.05          |          |
|  | ?                      | Other - please specify                         | on inquiry       |          |
| 3  | <b>Pressure range</b>  |  |                  |          |
|  | CA                     | -30 inHg ... 0                                 | \$86.05          |          |
|  | CD                     | -30 inHg ... 30 psi                            | \$86.05          |          |
|  | CF                     | -30 inHg ... 60 psi                            | \$86.05          |          |
|  | CH                     | -30 inHg ... 100 psi                           | \$86.05          |          |
|  | CK                     | -30 inHg ... 160 psi                           | \$86.05          |          |
|  | CL                     | -30 inHg ... 200 psi                           | \$86.05          |          |
|  | GG                     | 0 InWC ... 50 InWC                             | N/C              |          |
|  | GU                     | 0 InWC ... 100 InWC                            | N/C              |          |
|  | CN                     | 0 psi ... 5 psi                                | N/C              |          |
|  | CP                     | 0 psi ... 10 psi                               | N/C              |          |
|  | BC                     | 0 psi ... 15 psi (0 psi ... 15 psi absolute)   | N/C              |          |
|  | CQ                     | 0 psi ... 25 psi (0 psi ... 25 psi absolute)   | N/C              |          |
|  | BD                     | 0 psi ... 30 psi                               | N/C              |          |
|  | DA                     | 0 psi ... 50 psi (0 psi ... 50 psi absolute)   | N/C              |          |
|  | BE                     | 0 psi ... 60 psi                               | N/C              |          |
|  | BF                     | 0 psi ... 100 psi (0 psi ... 100 psi absolute) | N/C              |          |
|  | BG                     | 0 psi ... 160 psi                              | N/C              |          |
|  | BH                     | 0 psi ... 200 psi                              | N/C              |          |
|  | DG                     | 0 psi ... 250 psi (0 psi ... 250 psi absolute) | N/C              |          |
|  | BI                     | 0 psi ... 300 psi                              | N/C              |          |
|  | BK                     | 0 psi ... 400 psi                              | N/C              |          |
|  | BL                     | 0 psi ... 600 psi                              | N/C              |          |
|  | DJ                     | 0 psi ... 750 psi                              | N/C              |          |
|  | BN                     | 0 psi ... 1,000 psi                            | N/C              |          |
|  | BO                     | 0 psi ... 1,500 psi                            | N/C              |          |
|  | BP                     | 0 psi ... 2,000 psi                            | N/C              |          |
|  | BQ                     | 0 psi ... 3,000 psi                            | N/C              |          |
|  | BS                     | 0 psi ... 5,000 psi                            | N/C              |          |
|  | DS                     | 0 psi ... 8,000 psi                            | N/C              |          |
| ??   | Other - please specify | on inquiry                                     |                  |          |

# GENERAL PURPOSE

Electronic Pressure > General Purpose > F-20

ELECTRONIC PRESSURE

## F-21 Smart Codes for Custom Order Configurations (continued)

| Field no.                          | Code | Feature  | Additional price |
|------------------------------------|------|--|------------------|
| <b>Process connection</b>          |      |  |                  |
| 4                                  | 85   | G 1 B, flush diaphragm with O-ring (up to 25 psi)                        | N/C              |
|                                    | 86   | G 1/2 B, flush diaphragm with O-ring ( $\geq 30$ psi)                    | N/C              |
|                                    | ??   | Other - please specify   | on inquiry       |
| <b>Material of wetted parts</b>    |      |  |                  |
| 5                                  | 1    | Stainless steel, NBR O-Ring <sup>1)</sup>                                | N/C              |
|                                    | L    | Stainless steel, Viton <sup>®</sup> O-Ring                               | \$14.60          |
|                                    | ?    | Other - please specify   | on inquiry       |
| <b>Special design features</b>     |      |  |                  |
| 6                                  | Z    | Without  | N/C              |
|                                    | G    | Suitable for food  | \$59.60          |
|                                    | A    | Oxygen, oil and grease free (max. 140° F, $\geq 100$ inWC) <sup>2)</sup> | on inquiry       |
|                                    | ?    | Other - please specify   | on inquiry       |
| <b>Accuracy</b>                    |      |  |                  |
| 7                                  | G    | +/- 0.25% B.F.S.L.   | N/C              |
|                                    | K    | +/- 0.125% B.F.S.L.  | \$46.35          |
| <b>Electrical connection</b>       |      |  |                  |
| 8                                  | FE   | 1/2" NPT female conduit (IP67)   | N/C              |
|                                    | FH   | Nickel plated brass cable gland (IP68)                                   | N/C              |
|                                    | FC   | Stainless steel cable gland (IP68)                                       | \$39.75          |
|                                    | ??   | Other - please specify   | N/C              |
| <b>Temperature range of medium</b> |      |  |                  |
| 9                                  | A    | -30 ... +100° C (-22 ... +212° F)  | N/C              |
|                                    | B    | -40 ... +125° C (-40 ... +257° F)  | \$73.35          |
|                                    | C    | -20 ... +150° C (-4 ... +302° F) with cooling element                    | on inquiry       |
|                                    | X    | Changed because of diaphragm seal attachment                             | on inquiry       |
| <b>Quality certificates</b>        |      |  |                  |
| 10                                 | Z    | Without  | N/C              |
|                                    | I    | NIST Certificate of Calibration (always with 0.125% accuracy)            | \$72.80          |
| <b>Digital display</b>             |      |  |                  |
| 11                                 | Z    | Without  | N/C              |
|                                    | 1    | Digital display (order separately)                                       | on inquiry       |
| <b>Additional order details</b>    |      |  |                  |
| 12                                 | Z    | Without  | N/C              |
|                                    | T    | Additional order details   | on inquiry       |

1) Not available with cooling element option (Field 9, Code C)

2) Maximum media temperature is -4 ... +140° F (-20 ... +60° C) for pressure ranges 100 inWC to 500 psi.

TOTAL PRICE

Order Code: 1 2 3 4 5 6 7 8 9 10 11 12\*

**F-21** -  -  -  -  -  -

\*Additional order details

# GENERAL PURPOSE

Electronic Pressure > General Purpose > C-10

## Type C-10 General Purpose Pressure Transmitter

### Standard features

- **Signal output:** 4-20 mA 2-wire
- **Supply voltage:** 10-30 VDC
- **Process connection:** 1/4 NPT Male
- **Electrical connection:** DIN 43 650 with mini L-plug connector



ELECTRONIC PRESSURE

| Gauge Ranges |         |                 |
|--------------|---------|-----------------|
| Description  |         |                 |
| Range        | Part #  | Price           |
| 0-100 inWC   | 4204883 | <b>\$258.15</b> |
| 0-5 psi      | 8363434 |                 |
| 0-10 psi     | 4302940 |                 |
| 0-15 psi     | 8363442 |                 |
| 0-25 psi     | 8363450 |                 |
| 0-30 psi     | 4256671 |                 |
| 0-50 psi     | 8363468 |                 |
| 0-60 psi     | 8363476 |                 |
| 0-100 psi    | 8363515 |                 |
| 0-150 psi    | 8363485 |                 |
| 0-200 psi    | 8363493 |                 |
| 0-250 psi    | 4256698 |                 |
| 0-300 psi    | 8363506 |                 |
| 0-400 psi    | 4323697 |                 |
| 0-500 psi    | 9697688 |                 |
| 0-600 psi    | 8357247 |                 |
| 0-1,000 psi  | 8357255 |                 |
| 0-1,500 psi  | 8357264 |                 |
| 0-2,000 psi  | 8357272 |                 |
| 0-3,000 psi  | 8354753 |                 |
| 0-5,000 psi  | 8347390 |                 |
| 0-7,500 psi  | 8357280 |                 |
| 0-10,000 psi | 8357298 |                 |
| 0-15,000 psi | 8359576 |                 |































| Absolute Pressure Ranges |         |                 |
|--------------------------|---------|-----------------|
| Description              |         |                 |
| Range                    | Part #  | Price           |
| 0-15 psia                | 4228146 | <b>\$324.30</b> |
| 0-25 psia                | 4258615 |                 |
| 0-50 psia                | 4346127 |                 |

NOTE: Standard items shown and TRONIC 36 part numbers are shown in **bold print**. (Subject to prior sale)

# GENERAL PURPOSE

Electronic Pressure > General Purpose > C-10

## C-10 Smart Codes for Custom Order Configurations

| Field no. | Code   | Feature  | Base price       | \$258.15 |
|-----------|--|--|------------------|----------|
|           |  |  | Additional price |          |
|           |  | <b>Signal output</b>   |                  |          |
| 1         | A  | 4... 20 mA, 2-wire                                | N/C              |          |
|           | G  | 0... 5 V, 3-wire                                  | \$66.20          |          |
|           | F  | 0... 10 V, 3-wire (supply 14-30 V)                | \$66.20          |          |
|           | W  | 0.5... 4.5V ratiometric                           | \$66.20          |          |
|           | ?  | Other - please specify   | on inquiry       |          |
|           |  | <b>Unit</b>  |                  |          |
| 2         | P  | psi   | N/C              |          |
|           | N  | InWC    | N/C              |          |
|           | 3  | psi absolute (from 15 psi to 250 psi absolute)    | \$66.20          |          |
|           | ?  | Other - please specify   | on inquiry       |          |
|           |  | <b>Pressure range</b>  |                  |          |
| 3         | GU   | 0 InWC ... 100 InWC                               | N/C              |          |
|           | CN   | 0 psi ... 5 psi                                   | N/C              |          |
|           | CP   | 0 psi ... 10 psi                                  | N/C              |          |
|           | BC   | 0 psi ... 15 psi (0 psi ... 15 psi absolute)     | N/C              |          |
|           | CQ   | 0 psi ... 25 psi (0 psi ... 25 psi absolute)    | N/C              |          |
|           | BD   | 0 psi ... 30 psi                                | N/C              |          |
|           | DA   | 0 psi ... 50 psi (0 psi ... 50 psi absolute)    | N/C              |          |
|           | BE   | 0 psi ... 60 psi                                | N/C              |          |
|           | BF   | 0 psi ... 100 psi (0 psi ... 100 psi absolute)  | N/C              |          |
|           | DC   | 0 psi ... 150 psi                               | N/C              |          |
|           | BH   | 0 psi ... 200 psi                               | N/C              |          |
|           | DG   | 0 psi ... 250 psi (0 psi ... 250 psi absolute)  | N/C              |          |
|           | BI   | 0 psi ... 300 psi                               | N/C              |          |
|           | BK   | 0 psi ... 400 psi                               | N/C              |          |
|           | DI   | 0 psi ... 500 psi                               | N/C              |          |
|           | BL   | 0 psi ... 600 psi                               | N/C              |          |
|           | DJ   | 0 psi ... 750 psi                               | N/C              |          |
|           | BN   | 0 psi ... 1,000 psi                             | N/C              |          |
|           | BO   | 0 psi ... 1,500 psi                             | N/C              |          |
|           | BP   | 0 psi ... 2,000 psi                             | N/C              |          |
|           | BQ   | 0 psi ... 3,000 psi                             | N/C              |          |
|           | BS   | 0 psi ... 5,000 psi                             | N/C              |          |
|           | DS   | 0 psi ... 8,000 psi                             | N/C              |          |
|           | BT   | 0 psi ... 10,000 psi   | N/C              |          |
|           | BU   | 0 psi ... 15,000 psi   | N/C              |          |
| ??        | Other - up to maximum specified pressure range | on inquiry   |                  |          |























# GENERAL PURPOSE

Electronic Pressure > General Purpose > C-10

## C-10 Smart Codes for Custom Order Configurations (continued)

Field no. Code Feature



Additional price

|   | Process connection      |   |            |
|---|-------------------------|---|------------|
|   | NB                      | 1/4" NPT   | N/C        |
|   | ND                      | 1/2" NPT   | N/C        |
|   | NH                      | 1/8" NPT   | N/C        |
|   | GB                      | G 1/4 B   | N/C        |
|   | GD                      | G 1/2 B   | N/C        |
|   | NP                      | 1/4" NPT female    | \$63.55    |
|   | NQ                      | 1/2" NPT female    | \$63.55    |
|   | NR                      | 1/8" NPT female    | \$63.55    |
|   | UA                      | 7/16-20 UNF SAE #4 J514 male   | \$63.55    |
|   | UB                      | 7/16-20 UNF SAE #4 J514 female                                       | \$63.55    |
|   | UE                      | 9/16-18 UNF SAE #6 J514 male   | \$63.55    |
|   | UF                      | 9/16-18 UNF SAE #6 J514 female                                       | \$63.55    |
|   | UC                      | 3/4-16 UNF SAE #8 J514 male    | \$63.55    |
|   | UD                      | 3/4-16 UNF SAE #8 J514 female                                        | \$63.55    |
| 4 | ??                      | Other - please specify  | on inquiry |
|   | Special design features |   |            |
|   | Z                       | Without    | N/C        |
|   | A                       | Oxygen, oil and grease free <sup>1)</sup>   | \$86.05    |
| 5 | ?                       | Other - please specify  | on inquiry |
|   | Electrical connection   |   |            |
|   | II                      | DIN 43 650 with miniature L plug connector                         | N/C        |
|   | H2                      | 4 Pin miniature L-Plug DIN 43 650 w/molded cable (NEMA 5 / IP 65)  | \$35.35    |
|   | DL                      | Cable with free ends (NEMA 4 / IP67)  | \$37.05    |
|   | CR                      | Cable with free ends (NEMA 5 / IP65)                               | \$37.05    |
|   | M5                      | 5 Pin locking plug M12 x 1 (NEMA 5 / IP 65)                        | \$19.85    |
|   | B5                      | 5 Pin plug   | \$46.35    |
| 6 | ??                      | Other - please specify  | on inquiry |
|   | Cable length            |   |            |
|   | Z                       | Without    | N/C        |
|   | Y                       | 5 feet (only with H2, DL or CR)                                    | N/C        |
|   | 1                       | 10 feet (only with DL or CR)  | \$13.25    |
|   | 2                       | 20 feet (only with DL or CR)                                       | \$39.75    |
|   | 3                       | 30 feet (only with DL or CR)  | \$66.20    |
|   | 4                       | 40 feet (only with DL or CR)  | \$92.65    |
|   | 5                       | 50 feet (only with DL or CR)  | \$119.15   |
| 7 | ?                       | Other - please specify  | on inquiry |

# GENERAL PURPOSE

Electronic Pressure > General Purpose > C-10

## C-10 Smart Codes for Custom Order Configurations (continued)

| Field no. | Code | Feature   | Additional price |
|-----------|------|---|------------------|
|           |      | <b>Quality certificates</b>   |                  |
| 8         | Z    | Without                   | N/C              |
|           | I    | NIST Certificate of Calibration   | \$72.80          |
|           |      | <b>Digital display</b>  |                  |
| 9         | Z    | Without                   | N/C              |
|           |      | <b>Additional order details</b>   |                  |
| 10        | Z    | Without   | N/C              |
|           | T    | Additional order details  | on inquiry       |

1) Maximum media temperature is -4 ... +140° F (-20 ... +60° C) for pressure ranges 100 InWC to 300 psi.

TOTAL PRICE

ELECTRONIC PRESSURE



### TRONIC 36 Special Instructions:

If the **TRONIC 36** logo appears next to the selected feature for *all* fields, the transmitter qualifies for shipment within 36 hours as part of the TRONIC 36 program.

Order Code:

C-10 -  <sup>1</sup> -  <sup>2</sup>  <sup>3</sup> -  <sup>4</sup> -  <sup>5</sup>  <sup>6</sup>  <sup>7</sup> **A** -  <sup>8</sup>  <sup>9</sup>  <sup>10</sup> \*

\*Additional order details \_\_\_\_\_

# GENERAL PURPOSE

Electronic Pressure > General Purpose > A-10

## Type A-10 General Purpose Pressure Transmitter

### Standard features

- **Signal output:** 4-20 mA 2-wire or 0-10 V 3-wire
- **Supply voltage:** 8-30 DC (14-30 VDC)
- **Process connection:** 1/4 NPT male
- **Electrical connection:** DIN EN 175301-803 (DIN 43 650) with plug connector
- **Non-linearity:**  $\leq \pm 0.5\%$  B.F.S.L.

| Description      |                 |                 |          |
|------------------|-----------------|-----------------|----------|
| Range            | Part #          |                 | Price    |
|                  | 4-20 mA 2-wire  | 0-10 V 3-wire   |          |
| 0 ... 15 psia    | <b>50426354</b> | <b>50426737</b> | \$181.90 |
| 0 ... 100 psia   | <b>50426389</b> | <b>50426761</b> |          |
| 0 ... 15 psi     | <b>50426397</b> | <b>50426770</b> | \$146.75 |
| 0 ... 25 psi     | <b>50426401</b> | <b>50426788</b> |          |
| 0 ... 50 psi     | <b>50426427</b> | <b>50426800</b> |          |
| 0 ... 100 psi    | <b>50372475</b> | <b>50426818</b> |          |
| 0 ... 200 psi    | <b>50398083</b> | <b>50426834</b> |          |
| 0 ... 300 psi    | <b>50426460</b> | <b>50426842</b> |          |
| 0 ... 500 psi    | <b>50426478</b> | <b>50426851</b> |          |
| 0 ... 1,000 psi  | <b>50426486</b> | <b>50426869</b> |          |
| 0 ... 1,500 psi  | <b>50426494</b> | <b>50426877</b> |          |
| 0 ... 2,000 psi  | <b>50426508</b> | <b>50426885</b> |          |
| 0 ... 3,000 psi  | <b>50426516</b> | <b>50426893</b> |          |
| 0 ... 5,000 psi  | <b>50372483</b> | <b>50426907</b> |          |
| 0 ... 10,000 psi | <b>50426532</b> | <b>50426915</b> |          |

NOTE: Standard items shown in **bold print**. (Subject to prior sale)



ELECTRONIC PRESSURE



# GENERAL PURPOSE

Electronic Pressure > General Purpose > A-10

ELECTRONIC PRESSURE

| <b>A-10 Smart Codes for Custom Order Configurations</b> |      |   |    |                  |
|---|------|---|----|------------------|
| Field no.   | Code | Feature   |    | Base price       |
|   |      |   |    | <b>\$146.75</b>  |
|   |      |   |    | Additional price |
|   |      | <b>Non-linearity</b>                              |    |                  |
| 1   | 6    | ≤ ± 0.5% BFSL                                     |    | N/C              |
|   | 3    | ≤ ± 0.25% BFSL                                    |    | \$117.35         |
|   |      | <b>Unit</b>                                       |    |                  |
| 2   | P    | psi   |    | N/C              |
|   | ?    | Other   |    | on inquiry       |
|   |      | <b>Absolute or relative pressure</b>              |    |                  |
| 3   | G    | Gauge   |    | N/C              |
|   | A    | Absolute  |    | \$35.20          |
|   | V    | Compound  |    | \$35.20          |
|   |      | <b>Pressure range</b>                             |    |                  |
|   | 310  | 0 ... 15 psig    0 ... 15 psia    -30 inHg vacuum |    | N/C              |
|   | 317  | 0 ... 25 psig    0 ... 25 psia                    |    | N/C              |
|   | 321  | 0 ... 30 psig    0 ... 30 psia                    |    | N/C              |
|   | 331  | -30 inHg ... 30 psi                               |    | N/C              |
|   | 335  | 0 ... 50 psig    0 ... 50 psia                    |    | N/C              |
|   | 351  | -30 inHg ... 60 psi                               |    | N/C              |
|   | 369  | 0 ... 100 psig    0 ... 100 psia                  |    | N/C              |
|   | 379  | -30 inHg ... 100 psi                              |    | N/C              |
|   | 411  | 0 ... 160 psig                                    |    | N/C              |
|   | 412  | -30 inHg ... 160 psi                              |    | N/C              |
|   | 414  | 0 ... 200 psig                                    |    | N/C              |
|   | 415  | -30 inHg ... 200 psi                              |    | N/C              |
|   | 421  | 0 ... 300 psig    0 ... 300 psia                  |    | N/C              |
|   | 422  | -30 inHg ... 300 psi                              |    | N/C              |
|   | 434  | 0 ... 500 psig                                    |    | N/C              |
|   | 469  | 0 ... 1,000 psig                                  |    | N/C              |
|   | 510  | 0 ... 1,500 psig                                  |    | N/C              |
|   | 514  | 0 ... 2,000 psig                                  |    | N/C              |
|   | 521  | 0 ... 3,000 psig                                  |    | N/C              |
|   | 534  | 0 ... 5,000 psig                                  |    | N/C              |
|   | 569  | 0 ... 10,000 psig                                 |    | N/C              |
| 4   | ???  | Other   |    | on inquiry       |
|   |      | <b>Process connection</b>                         |    |                  |
| 5   | NB   | 1/4 NPT   | T2 | N/C              |
|   | NP   | 1/4 NPT female                                    | T2 | N/C              |
|   | ND   | 1/2 NPT   | T2 | N/C              |
|   | MV   | 7/16"-20 UNF SAE O-ring Boss                      | T1 | N/C              |
|   | MI   | M20 x 1.5   | T3 | N/C              |
|   | GB   | G 1/4 B   | T3 | N/C              |
|   | GD   | G 1/2 B   | T3 | N/C              |
|   | ??   | other   |    | on inquiry       |

# GENERAL PURPOSE

Electronic Pressure > General Purpose > A-10

## A-10 Smart Codes for Custom Order Configurations (continued)

ELECTRONIC PRESSURE

| Field no. | Code | Feature   | Additional price |            |         |
|-----------|------|---|------------------|------------|---------|
|           |      |   | T1               | T2         | T3      |
| 6         |      | <b>Sealing</b>                                    |                  |            |         |
|           |      | Thread type - see process connection              |                  |            |         |
|           | L    | FPM/FKM   | N/C              | -          | -       |
|           | C    | Copper  | -                | -          | N/C     |
| 6         | S    | Stainless steel                                   | -                | -          | \$12.90 |
|           | Z    | Without   |                  | N/C        |         |
| 7         |      | <b>Temperature range of medium</b>                |                  |            |         |
|           | Z    | 0...+80 °C (-32°F ... 176 °F)                     |                  | N/C        |         |
|           | A    | -30...+100 °C (-22°F ... 212 °F)                  |                  | \$29.40    |         |
| 8         |      | <b>Signal output</b>                              |                  |            |         |
|           | A    | 4 ... 20 mA, 2-wire                               |                  | N/C        |         |
|           | F    | 0 ... 10 V, 3-wire                                |                  | N/C        |         |
|           | G    | 0 ... 5 V, 3-wire                                 |                  | N/C        |         |
|           | K    | 1 ... 5 V, 3-wire                                 |                  | N/C        |         |
|           | W    | 0.5 ... 4.5 V, 3-wire ratiometric                 |                  | N/C        |         |
|           | ?    | Other   |                  | on inquiry |         |
| 9         |      | <b>Power supply</b>                               |                  |            |         |
|           | A    | 8...30 V DC (only with signal outputs A, G, or K) |                  | N/C        |         |
|           | C    | 14...30 V DC (only with signal output F)          |                  | N/C        |         |
|           | E    | 5 V DC +/- 10% (only with signal output W)        |                  | N/C        |         |
|           | ?    | Other   |                  | on inquiry |         |
| 10        |      | <b>Electrical connection</b>                      |                  |            |         |
|           | AG   | Valve connector, size A                           |                  | N/C        |         |
|           | AK   | Valve connector, size A with cable                |                  | \$41.05    |         |
|           | CG   | Valve connector, size C                           |                  | N/C        |         |
|           | CK   | Valve connector, size C with cable                |                  | on inquiry |         |
|           | M4   | Circular connector M12x1, 4 pin                   |                  | N/C        |         |
|           | MG   | Angled connector M12x1, 4 pin with cable          |                  | \$29.35    |         |
|           | MI   | Straight connector M12x1, 4 pin with cable        |                  | \$29.35    |         |
|           | DL   | Cable with free ends (IP 67)                      |                  | \$41.10    |         |
| 11        |      | <b>Cable length</b>                               |                  |            |         |
|           | Z    | Without   |                  | N/C        |         |
|           | 6    | 6 feet (only with: AK,CK, MG, MI, or DL)          |                  | N/C        |         |
|           | 7    | 15 feet (only with: AK,CK, MG, MI, or DL)         |                  | \$18.75    |         |
|           | ?    | Other   |                  | on inquiry |         |
| 12        |      | <b>Certificates</b>                               |                  |            |         |
|           | Z    | Without   |                  | N/C        |         |
| 13        |      | <b>Approvals</b>                                  |                  |            |         |
|           | S    | UL / CSA / GOST                                   |                  | N/C        |         |
|           | ?    | Other   |                  | on inquiry |         |

Order Code: 1 2 3 4 5 6 7 8 9 10 11 12 13\*

**A-10**  -    -    -   -   -

\*Additional order details \_\_\_\_\_

# GENERAL PURPOSE

Electronic Pressure > General Purpose > OT-1

## Type OT-1 General Purpose Pressure Transmitter 100 psi to 8,000 psi



Note: 50 piece minimum order quantity applies.

### OT-1 Smart Codes for Custom Order Configurations

| Field no. | Code | Feature                       | Base price       | \$112.55   |
|-----------|------|-------------------------------|------------------|------------|
|           |      |                               | Additional price |            |
|           |      | <b>Signal output</b>          |                  |            |
|           | A    | 4 ... 20 mA, 2-wire           |                  | N/C        |
|           | K    | 1 ... 5 V, 3-wire             |                  | N/C        |
|           | F    | 0 ... 10, 3-wire              |                  | N/C        |
|           | W    | 0.5 - 4.5V 3-wire ratiometric |                  | N/C        |
| <b>1</b>  | ?    | Other - please specify        |                  | on inquiry |
|           |      | <b>Unit</b>                   |                  |            |
|           | P    | psi                           |                  | N/C        |
| <b>2</b>  | ?    | Other - please specify        |                  | on inquiry |
|           |      | <b>Pressure range</b>         |                  |            |
|           | CH   | 30 inHg ... 100 psi           |                  | N/C        |
|           | CL   | 30 inHg ... 200 psi           |                  | N/C        |
|           | BF   | 0 psi ... 100 psi             |                  | N/C        |
|           | DC   | 0 psi ... 150 psi             |                  | N/C        |
|           | DG   | 0 psi ... 250 psi             |                  | N/C        |
|           | BI   | 0 psi ... 300 psi             |                  | N/C        |
|           | DI   | 0 psi ... 500 psi             |                  | N/C        |
|           | BN   | 0 psi ... 1,000 psi           |                  | N/C        |
|           | BO   | 0 psi ... 1,500 psi           |                  | N/C        |
|           | BP   | 0 psi ... 2,000 psi           |                  | N/C        |
|           | BQ   | 0 psi ... 3,000 psi           |                  | N/C        |
|           | BS   | 0 psi ... 5,000 psi           |                  | N/C        |
|           | DS   | 0 psi ... 8,000 psi           |                  | N/C        |
| <b>3</b>  | ??   | Other - please specify        |                  | on inquiry |

# GENERAL PURPOSE

Electronic Pressure > General Purpose > OT-1

## OT-1 Smart Codes for Custom Order Configurations (continued)

| Field no. | Code | Feature                                     | Additional price |
|-----------|------|---|------------------|
|           |      | <b>Process connection</b>                   |                  |
|           | NB   | 1/4" NPT                                    | N/C              |
|           | MV   | 7/16-20 UNF SAE #4 J514 male w/ O-ring boss | N/C              |
|           | GB   | G 1/4 B                                     | N/C              |
|           | HD   | G 1/4 B DIN 3852-E                          | N/C              |
|           | HN   | M 14x1.5 DIN 3852-E                         | N/C              |
| <b>4</b>  | ??   | Other - please specify                      | on inquiry       |
|           |      | <b>Electrical connection</b>                |                  |
|           | M4   | 4 Pin locking plug M12 x 1 (NEMA 4 / IP 67) | N/C              |
|           | R3   | Connector metri pack series 150, 3-pin      | N/C              |
|           | DL   | Cable with free ends (NEMA 4 / IP 67)       | \$18.55          |
|           | G3   | Deutsch 3 pin DT04-3P                       | N/C              |
|           | S3   | AMP superseal 1.5 3-pin (NEMA 4 / IP 67)    | N/C              |
| <b>5</b>  | ??   | Other - please specify                      | on inquiry       |
|           |      | <b>Cable length</b>                         |                  |
|           | Z    | Without (always with plug version)          | N/C              |
|           | A    | 0.5 meter (1.6 feet)                        | N/C              |
|           | B    | 2 meter (6.5 feet)                          | \$6.60           |
|           | G    | 5 meter (16.4 feet)                         | \$19.85          |
| <b>6</b>  | ?    | Other                                       | on inquiry       |
|           |      | <b>Quality certificates</b>                 |                  |
|           | Z    | Without                                     | N/C              |
| <b>7</b>  | 1    | Other - please specify                      | on inquiry       |
|           |      | <b>Digital display</b>                      |                  |
|           | Z    | Without                                     | N/C              |
| <b>8</b>  | 1    | Digital display (order separately)          | on inquiry       |
|           |      | <b>Additional order details</b>             |                  |
|           | Z    | Without                                     | N/C              |
| <b>9</b>  | T    | Additional order details                    | on inquiry       |

ELECTRONIC PRESSURE

**Note: 50 piece minimum order quantity applies.**

TOTAL PRICE

Order Code:      1      2      3      4      5      6      7      8      9\*

**OT - 1** -  -   -  -   -

\*Additional order details \_\_\_\_\_

# GENERAL PURPOSE

Electronic Pressure > General Purpose > DG-10

## Type DG-10 Digital Pressure Gauge

### Standard features

- **Case:** 3.15" diameter stainless steel
- **Process connection:** 1/4" NPT male
- **Power requirements:** 2 AA batteries
- **Stocked enhanced version includes protective rubber boot**

ELECTRONIC PRESSURE



Type DG-10-S



Type DG-10-E

| Description         |                               |                 |                               |                 |
|---------------------|-------------------------------|-----------------|-------------------------------|-----------------|
| Range               | DG-10-S<br>Standard<br>Part # | Price           | DG-10-E<br>Enhanced<br>Part # | Price           |
| -30 inHg...29 psi   | 50365444                      |                 | 50365657                      |                 |
| -30 inHg...72 psi   | 50365452                      | <b>\$353.50</b> | 50365673                      | <b>\$439.45</b> |
| -30 inHg...145 psi  | 50365461                      |                 | 50365690                      |                 |
| 0 psi ... 30 psi    | 50365479                      |                 | 50365720                      |                 |
| 0 psi ...60 psi     | 50365487                      |                 | 50365771                      |                 |
| 0 psi ...145 psi    | 50365495                      | <b>\$324.00</b> | 50365789                      | <b>\$410.00</b> |
| 0 psi ...300 psi    | 50365509                      |                 | 50365797                      |                 |
| 0 psi ...600 psi    | 50365517                      |                 | 50365819                      |                 |
| 0 psi ...1,450 psi  | 50365525                      |                 | 50365827                      |                 |
| 0 psi ...2,000 psi  | 50365584                      |                 | 50365835                      |                 |
| 0 psi ...3,000 psi  | 50365592                      | <b>\$353.50</b> | 50365843                      | <b>\$439.45</b> |
| 0 psi ...5,000 psi  | 50365614                      |                 | 50365851                      |                 |
| 0 psi ...7,500 psi  | 50365622                      |                 | 50365860                      |                 |
| 0 psi ...10,000 psi | 50365631                      |                 | 50365878                      |                 |



# GENERAL PURPOSE

Electronic Pressure > General Purpose > DG-10

ELECTRONIC PRESSURE

| <b>DG-10 Smart Codes for Custom Order Configurations</b> |      |   |                  |
|--|------|---|------------------|
| Field no.  | Code | Feature   | Base price       |
|  |      |   | <b>\$324.00</b>  |
|  |      |   | Additional price |
|  |      | <b>Model</b>  |                  |
| 1  | S    | Standard  | N/C              |
|  | E    | Enhanced <i>among others: Tare-function, backlit display</i>    | \$76.60          |
|  |      | <b>Display</b>  |                  |
| 2  | 8    | LCD, 4-digit from -1,999 ... 9,999 <i>Type S</i>                | N/C              |
|  | C    | LCD, 4½-digit from -1,999 ... 9,999 + 2nd Display <i>Type E</i> | N/C              |
|  |      | <b>Unit</b>   |                  |
| 3  | P    | psi   | N/C              |
|  |      | <b>Absolute or relative pressure</b>                            |                  |
| 4  | G    | Gauge   | N/C              |
|  | V    | Compound  | N/C              |
|  |      | <b>Pressure range</b>   |                  |
| 5  | 330  | -30 InHg ... 29 psi   | \$29.45          |
|  | 360  | -30 InHg ... 72 psi   | \$29.45          |
|  | 411  | -30 InHg ... 145 psi  | \$29.45          |
|  | 321  | 0 ... 30 psi  | N/C              |
|  | 341  | 0 ... 60 psi  | N/C              |
|  | 399  | 0 ... 145 psi   | N/C              |
|  | 421  | 0 ... 300 psi   | N/C              |
|  | 441  | 0 ... 600 psi   | N/C              |
|  | 499  | 0 ... 1,450 psi   | \$29.45          |
|  | 514  | 0 ... 2,000 psi   | \$29.45          |
|  | 521  | 0 ... 3,000 psi   | \$29.45          |
|  | 534  | 0 ... 5,000 psi   | \$29.45          |
|  | 552  | 0 ... 7,500 psi   | \$29.45          |
|  | 569  | 0 ... 10,000 psi  | \$29.45          |
|  |      | <b>Process connection</b>                                       |                  |
| 6  | ND   | ½ NPT   | N/C              |
|  | NB   | ¼ NPT   | N/C              |
|  | GD   | G ½ B   | N/C              |
|  | GB   | G ¼ B   | N/C              |
|  | HD   | G ¼ B DIN 3852-E  | N/C              |
|  |      | <b>Material of wetted parts</b>                                 |                  |
| 7  | K    | Stainless steel, ceramic and sealing <i>&lt; 600 psi</i>        | N/C              |
|  | Q    | Stainless steel <i>≥ 1,450 psi</i>                              | N/C              |
|  |      | <b>Temperature range of medium</b>                              |                  |
| 8  | D    | -20 ... +85 °C (-4 ... +185 °F) <i>&lt; 600 psi</i>             | N/C              |
|  | A    | -30 ... +100 °C (-22 ... +212 °F) <i>≥ 1,450 psi</i>            | N/C              |

# GENERAL PURPOSE

Electronic Pressure > General Purpose > DG-10

ELECTRONIC PRESSURE

## DG-10 Smart Codes for Custom Order Configurations (continued)

| Field no. | Code                            | Feature                           | Additional price |
|-----------|---------------------------------|-----------------------------------|------------------|
| 9         | <b>Sealing</b>                  |                                   |                  |
|           | Z                               | Without                           | N/C              |
|           | 1                               | NBR                               | N/C              |
|           | B                               | EPDM                              | N/C              |
| 10        | <b>Certificates</b>             |                                   |                  |
|           | Z                               | Without                           | N/C              |
|           | I                               | NIST certificate                  | \$72.80          |
| 11        | <b>Protective rubber boot</b>   |                                   |                  |
|           | Z                               | Without                           | N/C              |
|           | S                               | Vulcanized rubber protective boot | \$9.40           |
| 12        | <b>Additional Order Details</b> |                                   |                  |
|           | Z                               | Without                           | N/C              |
|           | T                               | Additional text                   | N/C              |

TOTAL PRICE

Order Code:

DG-10 -  - D 1  -  -  - Z Z  -

\*Additional order details \_\_\_\_\_

# GENERAL PURPOSE

Electronic Pressure > General Purpose > PSD-30

## Type PSD-30 Pressure Transmitter with Integral LED Display and Programmable Solid-state Switches

### Standard features

- **Signal output:** 4-20 mA 2-wire
- **Switch outputs:** 2, PNP
- **Process connection:** 1/4 NPT Male
- **Electrical connection:** 5 pin locking plug M12 x 1

### PSD-30 Part Numbers

| Item Number | Description                                   | Price           |
|-------------|---|-----------------|
| 50709267    | PSD-30 15 psi 4-20MA 1/4NPT P/P 5PLCK         | <b>\$349.95</b> |
| 50709275    | PSD-30 25 psi 4-20MA 1/4NPT P/P 5PLCK         |                 |
| 50709283    | PSD-30 50 psi 4-20MA 1/4NPT P/P 5PLCK         |                 |
| 50709321    | PSD-30 100 psi 4-20MA 1/4NPT P/P 5PLCK        |                 |
| 50709330    | PSD-30 200 psi 4-20MA 1/4NPT P/P 5PLCK        |                 |
| 50709356    | PSD-30 500 psi 4-20MA 1/4NPT P/P 5PLCK        |                 |
| 50709364    | PSD-30 2,000 psi 4-20MA 1/4NPT P/P 5PLCK      |                 |
| 50709372    | PSD-30 3,000 psi 4-20MA 1/4NPT P/P 5PLCK      |                 |
| 50709381    | PSD-30 5,000 psi 4-20MA 1/4NPT P/P 5PLCK      |                 |
| 50709402    | PSD-30 -14.5 psi VAC 4-20MA 1/4NPT P/P 5PLCK  | <b>\$379.40</b> |
| 50709411    | PSD-30 -14.5/+100 psi 4-20MA 1/4NPT P/P 5PLCK |                 |
| 50709496    | PSD-30 100 psi 0-10V 1/4NPT P/P 5PLCK         |                 |

Note: "P/P" means dual PNP/PNP switches.

N/N is NPN/NPN dual switches; single switches will show a single P or N in the description.

NOTE: Standard items shown in **bold print**. (Subject to prior sale)



ELECTRONIC PRESSURE

# GENERAL PURPOSE

Electronic Pressure > General Purpose > PSD-30

ELECTRONIC PRESSURE

| PSD-30 Smart Codes for Custom Order Configurations |      |   |   |            |
|--|------|---|---|------------|
| Field no.  | Code | Feature                                 | Base price                                      |            |
|  |      |   | <b>\$349.95</b>                                 |            |
|  |      |   | Additional price                                |            |
| 1  |      | <b>Signal output</b>                    |   |            |
|  | Q    | Dual PNP switch output + 4...20mA       | N/C   |            |
|  | R    | Dual PNP switch output + 0...10V        | N/C   |            |
|  | V    | Dual NPN switch output + 4...20mA       | N/C   |            |
|  | ?    | Other                                   | on inquiry                                      |            |
| 2  |      | <b>Unit</b>                             |   |            |
|  | P    | PSI (Selectable BAR/PSI/MPA/KPA/KG/cm2) | N/C   |            |
|  | ?    | Other                                   | on inquiry                                      |            |
| 3  |      | <b>Pressure reference</b>               |   |            |
|  | G    | Gauge                                   | N/C   |            |
|  | A    | Absolute                                | \$29.45   |            |
|  | V    | Compound                                | \$29.45   |            |
| 4  |      | <b>Pressure range</b>                   |   |            |
|  | 310  | -14.5 psi...0                           | N/C   |            |
|  | 320  | -14.5 psi...15 psi                      | N/C   |            |
|  | 351  | -14.5 psi...60 psi                      | N/C   |            |
|  | 379  | -14.5 psi...100 psi                     | N/C   |            |
|  | 415  | -14.5 psi...200 psi                     | N/C   |            |
|  | 422  | -14.5 psi...300 psi                     | N/C   |            |
|  | 310  | 0...15 psi      0...15 psia             | N/C   |            |
|  | 317  | 0...25 psi      0...25 psia             | N/C   |            |
|  | 321  | 0...30 psi      0...30 psia             | N/C   |            |
|  | 335  | 0...50 psi      0...50 psia             | N/C   |            |
|  | 369  | 0...100 psi      0...100 psia           | N/C   |            |
|  | 411  | 0...160 psi      0...160 psia           | N/C   |            |
|  | 414  | 0...200 psi      0...200 psia           | N/C   |            |
|  | 421  | 0...300 psi      0...300 psia           | N/C   |            |
|  | 434  | 0...500 psi                             | N/C   |            |
|  | 469  | 0...1,000 psi                           | N/C   |            |
|  | 514  | 0...2,000 psi                           | N/C   |            |
|  | 521  | 0...3,000 psi                           | N/C   |            |
|  | 534  | 0...5,000 psi                           | N/C   |            |
|  | 555  | 0...8,000 psi                           | N/C   |            |
|  | ???  | Other                                   | on inquiry                                      |            |
|  | 5    |   | <b>Process connection</b>                       |            |
|  |      | NB                                      | 1/4" NPT  | N/C        |
|  |      | HD                                      | G 1/4 A DIN 3852-E                              | N/C        |
|  |      | TB                                      | G 1/4 female                                    | N/C        |
|  |      | ??                                      | Other   | on inquiry |
|  | 6    |   | <b>Process seal ring (not required for NPT)</b> |            |
|  |      | C                                       | Copper  | N/C        |
| S  |      | Stainless steel                         | \$9.40  |            |
| Z  |      | Without                                 | N/C   |            |
| ?  |      | Other                                   | on inquiry                                      |            |

# GENERAL PURPOSE

Electronic Pressure > General Purpose > PSD-30

## PSD-30 Smart Codes for Custom Order Configurations (continued)

Field no. Code Feature

|    |                                 |                                   | Additional price |
|----|---------------------------------|-----------------------------------|------------------|
| 7  | <b>Special design features</b>  |                                   |                  |
|    | Z                               | Without                           | N/C              |
|    | E                               | Oil and grease free               | on inquiry       |
| 8  | <b>Electrical connection</b>    |                                   |                  |
|    | M5                              | 5 pin locking plug M12x1          | N/C              |
|    | ??                              | Other                             | on inquiry       |
| 9  | <b>Instrument configuration</b> |                                   |                  |
|    | W                               | Factory standard switch settings  | N/C              |
|    | K                               | Customer specific switch settings | on inquiry       |
| 10 | <b>Approvals</b>                |                                   |                  |
|    | W                               | UL / CSA                          | on inquiry       |
|    | Z                               | Without                           | N/C              |

ELECTRONIC PRESSURE

| <b>Special design features</b> |     |    |                      |
|--------------------------------|-----|----|----------------------|
|                                | YES | NO |                      |
| 11                             | 1   | Z  | Quality certificates |
| 12                             | T   | Z  | Additional text      |

Order Code:

1      2 3      4      5 6 7      8      9 10      11 12

**PSD-30**  -  -  -  -  -

\*Additional order details \_\_\_\_\_

# GENERAL PURPOSE

Electronic Pressure > General Purpose > TSD-30

ELECTRONIC PRESSURE

| TSD-30 Smart Codes for Custom Order Configurations |      |   |                  |
|--|------|---|------------------|
| Field no.  | Code | Feature   | Base price       |
|  |      |   | <b>\$281.60</b>  |
|  |      |   | Additional price |
|  |      | <b>Signal output</b>                            |                  |
| 1  | Q    | Dual PNP switch output + 4...20mA               | N/C              |
|  | R    | Dual PNP switch output + 0...10V                | N/C              |
|  | V    | Dual NPN switch output + 4...20mA               | N/C              |
|  | ?    | Other   | on inquiry       |
|  |      | <b>Unit</b>                                     |                  |
| 2  | F    | Degrees °F (user selectable for °C)             | N/C              |
|  | ?    | Other   | on inquiry       |
|  |      | <b>Temperature range</b>                        |                  |
| 3  | A    | -4 ... +176 °F (user selectable for °C)         | N/C              |
|  | ?    | Other   | on inquiry       |
|  |      | <b>Probe length</b>                             |                  |
| 4  | 0025 | 0.98" / 25 mm                                   | N/C              |
|  | 0050 | 1.97" / 50 mm                                   | N/C              |
|  | 0100 | 3.94" / 100 mm                                  | N/C              |
|  | 0150 | 5.91" / 150 mm                                  | \$5.10           |
|  | 0250 | 9.84" / 250 mm                                  | \$10.25          |
|  | 0300 | 13.78" / 350 mm                                 | \$15.35          |
|  | ???? | Other   | on inquiry       |
|  |      | <b>Process connection</b>                       |                  |
| 5  | ND   | 1/2" NPT  | N/C              |
|  | NB   | 1/4" NPT  | N/C              |
|  | GT   | G 1/2 A DIN 3852-E                              | N/C              |
|  | ??   | Other   | on inquiry       |
|  |      | <b>Process seal ring (not required for NPT)</b> |                  |
| 6  | Z    | Without   | N/C              |
|  | 1    | NBR   | N/C              |
|  | L    | FPM / FKM                                       | N/C              |
|  | ?    | Other   | on inquiry       |
|  |      | <b>Electrical connection</b>                    |                  |
| 7  | M5   | 5 pin locking plug M12x1 (NEMA 5 / IP65)        | N/C              |
|  | ??   | Other   | on inquiry       |

# GENERAL PURPOSE

Electronic Pressure > General Purpose > TSD-30

## TSD-30 Smart Codes for Custom Order Configurations (continued)

| Field no. | Code                            | Feature                                  | Additional price |
|-----------|---------------------------------|--|------------------|
| 8         | <b>Instrument configuration</b> |  |                  |
|           | W                               | Factory default settings (see datasheet) | N/C              |
|           | K                               | Customer specifications                  | on inquiry       |
| 9         | <b>Approvals</b>                |  |                  |
|           | Z                               | Without                                  | N/C              |
|           | ?                               | Other                                    | on inquiry       |

|    | <b>Special design features</b> |    |                      |
|----|--------------------------------|----|----------------------|
|    | YES                            | NO |                      |
| 11 | 1                              | Z  | Quality certificates |
| 12 | T                              | Z  | Additional text      |

ELECTRONIC PRESSURE

Order Code:

1
2 3
4
5 6
7
8 9
10 11

**TSD-30** -  -  -  -  -  -  -

\*Additional order details \_\_\_\_\_

# GENERAL PURPOSE

Electronic Pressure > General Purpose > LSD-30

ELECTRONIC PRESSURE

| LSD-30 Smart Codes for Custom Order Configurations |   |  |                         |
|--|---|--|-------------------------|
| Field no.  | Code  | Feature                                  | Base price              |
|  |   |  | <b>\$509.95</b>         |
|  |   |  | <b>Additional price</b> |
| 1  | <b>Signal output</b>                            |  |                         |
|  | Q   | Dual PNP switch output + 4...20mA        | N/C                     |
|  | R   | Dual PNP switch output + 0...10V         | N/C                     |
|  | V   | Dual NPN switch output + 4...20mA        | N/C                     |
|  | ?   | Other                                    | on inquiry              |
| 2  | <b>Display unit</b>                             |  |                         |
|  | I   | Inch (user selectable for mm, cm, %)     | N/C                     |
|  | ?   | Other                                    | on inquiry              |
| 3  | <b>Probe length</b>                             |  |                         |
|  | 0250  | 250 mm / 9.84"                           | N/C                     |
|  | 0370  | 370 mm / 14.57"                          | \$81.90                 |
|  | 0410  | 410 mm / 16.14"                          | \$107.50                |
|  | 0520  | 520 mm / 20.47"                          | \$184.30                |
|  | 0730  | 730 mm / 27.74"                          | \$332.80                |
|  | ????  | Other                                    | on inquiry              |
| 4  | <b>Process connection</b>                       |  |                         |
|  | NE  | 3/4" NPT                                 | N/C                     |
|  | NH  | G 3/4 A DIN 3852-E                       | N/C                     |
|  | ??  | Other                                    | on inquiry              |
| 5  | <b>Process seal ring (not required for NPT)</b> |  |                         |
|  | Z   | Without (always with NPT)                | N/C                     |
|  | 1   | NBR                                      | N/C                     |
|  | L   | FPM / FKM                                | N/C                     |
|  | ?   | Other                                    | on inquiry              |
| 6  | <b>Electrical connection</b>                    |  |                         |
|  | M5  | 5 pin locking plug M12x1 (NEMA 4 / IP67) | N/C                     |
|  | ??  | Other                                    | on inquiry              |
| 7  | <b>Instrument configuration</b>                 |  |                         |
|  | W   | Factory default settings (see datasheet) | N/C                     |
|  | K   | Customer specifications                  | on inquiry              |
| 8  | <b>Approvals</b>                                |  |                         |
|  | Z   | Without                                  | N/C                     |
|  | ?   | Other                                    | on inquiry              |

| Quality certificates |     |    |                      |
|----------------------|-----|----|----------------------|
| 9                    | YES | NO |                      |
|                      | 1   | Z  | Quality certificates |
| 10                   | T   | Z  | Additional text      |

Order Code:

1      2      3      4 5      6      7 8      9 10

**LSD-30** -  -  -  -   -  -   -

\*Additional order details \_\_\_\_\_



# HAZARDOUS AREA

Electronic Pressure > Hazardous Area > E-10

## Type E-10 Explosion-proof Pressure Transmitter Vacuum to 15,000 psi



### Standard features

- **Signal output:** 4-20mA, 2-wire or 1-5 V 3-wire low power
- **Supply voltage:** 10-30 VDC or 6-30 VDC (low power version)
- **Process connection:** 1/4" or 1/2" NPT male
- **Electrical connection:** 1/2" male conduit with cable or flying leads

### E-10 Part Numbers

To use this table, first find the required process connection (1/4" or 1/2" NPT male), then the signal output (4-20 mA or 1-5 V), electrical connection (cable or flying lead) and the required pressure range.

| Pressure conn.         | 1/4" NPT male                          |                 |                       |                 | 1/2" NPT male                          |                 |                       |                 |
|------------------------|--|-----------------|-----------------------|-----------------|--|-----------------|-----------------------|-----------------|
|                        | 4-20 mA                                |                 | 1-5V 3-wire low power |                 | 4-20 mA                                |                 | 1-5V 3-wire low power |                 |
| Signal output          | 1/2" NPT male conduit connection with: |                 |                       |                 |  |                 |                       |                 |
|                        | 6ft cable                              |                 | 6ft leads             |                 | 6ft cable                              |                 | 6ft leads             |                 |
| Electrical conn.       | 1/2" NPT male conduit connection with: |                 |                       |                 | 1/2" NPT male conduit connection with: |                 |                       |                 |
|                        | 6ft cable                              |                 | 6ft leads             |                 | 6ft cable                              |                 | 6ft leads             |                 |
| <b>Compound ranges</b> |  |                 |                       |                 |  |                 |                       |                 |
| <b>List price</b>      | <b>\$427.20</b>                        | <b>\$487.35</b> | <b>\$427.20</b>       | <b>\$487.35</b> | <b>\$427.20</b>                        | <b>\$487.35</b> | <b>\$427.20</b>       | <b>\$487.35</b> |
| 30"-0 inHg vac         | 52131793                               |                 |                       |                 | 4371130                                |                 |                       |                 |
| 30"-0-30 psi           | <b>4217172</b>                         | 50333330        |                       |                 | <b>4365016</b>                         | 4365131         | <b>4365255</b>        |                 |
| 30"-0-100 psi          | <b>50116703</b>                        | 50300156        |                       |                 | 4365026                                | 4365149         | 4365271               |                 |
| <b>Gauge ranges</b>    |  |                 |                       |                 |  |                 |                       |                 |
| <b>List price</b>      | <b>\$391.10</b>                        | <b>\$451.30</b> | <b>\$391.10</b>       | <b>\$451.30</b> | <b>\$391.10</b>                        | <b>\$451.30</b> | <b>\$391.10</b>       | <b>\$451.30</b> |
| 15 psi                 |  | 50989333        | 50792261              | <b>50034669</b> | <b>4365034</b>                         | <b>4365157</b>  | 4365289               | 4365386         |
| 60 psi                 | <b>4363082</b>                         | <b>50989341</b> |                       | 50437178        | <b>4365042</b>                         | <b>4365166</b>  | <b>4365297</b>        | 50916572        |
| 100 psi                | <b>4363090</b>                         | <b>4363189</b>  | <b>4363341</b>        | 50391020        | <b>4365050</b>                         | <b>4365174</b>  | <b>4365301</b>        | <b>4365395</b>  |
| 200 psi                | <b>4364844</b>                         | 50139061        | 4242150               | <b>4368653</b>  | <b>4369633</b>                         | 50033948        | 50834967              | 4254174         |
| 300 psi                | <b>4363103</b>                         | <b>4363197</b>  | <b>4363359</b>        | <b>4368661</b>  | <b>4365068</b>                         | <b>4365182</b>  | <b>4365319</b>        | 50707329        |
| 500 psi                | 4363111                                | <b>4363200</b>  | <b>4363367</b>        | <b>4368679</b>  | <b>4365076</b>                         | <b>4365190</b>  | <b>4365327</b>        | <b>4365408</b>  |
| 1,000 psi              | <b>4363129</b>                         | <b>4363218</b>  | <b>4363376</b>        | <b>4365337</b>  | <b>4365085</b>                         | <b>4365204</b>  | <b>4365336</b>        | 4365418         |
| 1,500 psi              | <b>4363137</b>                         | <b>4363226</b>  | <b>4363384</b>        | <b>4248337</b>  | <b>4364169</b>                         | <b>4374130</b>  | <b>4391256</b>        | <b>4254166</b>  |
| 2,000 psi              | <b>4363146</b>                         | <b>4363236</b>  | <b>4363392</b>        | <b>4368687</b>  | <b>4365093</b>                         | <b>4365212</b>  | <b>4365344</b>        | <b>4254158</b>  |
| 3,000 psi              | <b>4202506</b>                         | <b>4363244</b>  | <b>4363406</b>        | <b>4248329</b>  | <b>4365106</b>                         | 4365220         | <b>4365352</b>        | <b>4365425</b>  |
| 5,000 psi              | <b>4363155</b>                         | <b>4363252</b>  | <b>4363414</b>        | 4394034         | <b>4365115</b>                         | <b>4365238</b>  | <b>4365360</b>        | <b>4365433</b>  |
| 8,000 psi              | 4363163                                | 4363260         | 50308696              | 50988906        | 50070568                               |                 |                       | 50555022        |
| 10,000 psi             | <b>4363171</b>                         |                 | <b>4363422</b>        | 50136623        | <b>4365123</b>                         | <b>4365246</b>  | <b>4365378</b>        | <b>4260957</b>  |
| 15,000 psi             |  | 52166112        | 4216673               |                 | 50603914                               | 52156303        | <b>4216681</b>        | <b>50131613</b> |

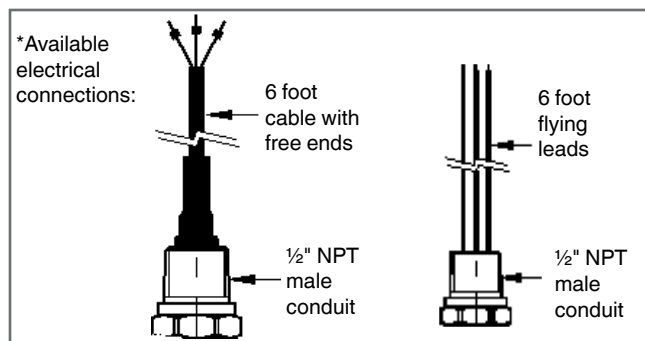

NOTE: Standard items shown in **bold print**. (Subject to prior sale)

Items without part numbers are available on special order.

ELECTRONIC PRESSURE

# HAZARDOUS AREA

Electronic Pressure > Hazardous Area > E-10

## E-10 Smart Codes for Custom Order Configurations

| Field no. | Code                   | Feature  | Base price       | \$391.10 |
|-----------|------------------------|--|------------------|----------|
|           |                        |  | Additional price |          |
|           |                        | <b>Signal output</b>                           |                  |          |
| 1         | A                      | 4 ... 20 mA, 2-wire                            | N/C              |          |
|           | K                      | 1 ... 5 V, 3-wire                              | N/C              |          |
|           | ?                      | Other - please specify                         | on inquiry       |          |
|           |                        | <b>Unit</b>                                    |                  |          |
| 2         | P                      | psi  | N/C              |          |
|           | 3                      | psi absolute                                   | \$36.10          |          |
|           | ?                      | Other - please specify                         | on inquiry       |          |
|           |                        | <b>Pressure range</b>                          |                  |          |
| 3         | CA                     | -30 inHg ... 0                                 | \$36.10          |          |
|           | CD                     | -30 inHg ... 30 psi                            | \$36.10          |          |
|           | CF                     | -30 inHg ... 60 psi                            | \$36.10          |          |
|           | CH                     | -30 inHg ... 100 psi                           | \$36.10          |          |
|           | CL                     | -30 inHg ... 200 psi                           | \$36.10          |          |
|           | CN                     | 0 psi ... 5 psi                                | N/C              |          |
|           | CP                     | 0 psi ... 10 psi                               | N/C              |          |
|           | BC                     | 0 psi ... 15 psi (0 psi ... 15 psi absolute)   | N/C              |          |
|           | CQ                     | 0 psi ... 25 psi (0 psi ... 25 psi absolute)   | N/C              |          |
|           | BD                     | 0 psi ... 30 psi                               | N/C              |          |
|           | DA                     | 0 psi ... 50 psi (0 psi ... 50 psi absolute)   | N/C              |          |
|           | BE                     | 0 psi ... 60 psi                               | N/C              |          |
|           | BF                     | 0 psi ... 100 psi (0 psi ... 100 psi absolute) | N/C              |          |
|           | BG                     | 0 psi ... 160 psi                              | N/C              |          |
|           | BH                     | 0 psi ... 200 psi                              | N/C              |          |
|           | DG                     | 0 psi ... 250 psi                              | N/C              |          |
|           | BI                     | 0 psi ... 300 psi                              | N/C              |          |
|           | DI                     | 0 psi ... 500 psi                              | N/C              |          |
|           | DJ                     | 0 psi ... 750 psi                              | N/C              |          |
|           | BN                     | 0 psi ... 1,000 psi                            | N/C              |          |
|           | BO                     | 0 psi ... 1,500 psi                            | N/C              |          |
|           | BP                     | 0 psi ... 2,000 psi                            | N/C              |          |
|           | BQ                     | 0 psi ... 3,000 psi                            | N/C              |          |
|           | BS                     | 0 psi ... 5,000 psi                            | N/C              |          |
|           | DS                     | 0 psi ... 8,000 psi                            | N/C              |          |
|           | BT                     | 0 psi ... 10,000 psi                           | N/C              |          |
|           | BU                     | 0 psi ... 15,000 psi                           | N/C              |          |
| ??        | Other - please specify | on inquiry                                     |                  |          |
|           |                        | <b>Process connection</b>                      |                  |          |
| 4         | NB                     | 1/4" NPT                                       | N/C              |          |
|           | ND                     | 1/2" NPT                                       | N/C              |          |
|           | ??                     | Other - please specify                         | on inquiry       |          |

# HAZARDOUS AREA

Electronic Pressure > Hazardous Area > E-10

## E-10 Smart Codes for Custom Order Configurations (continued)

| Field no. | Code | Feature   | Additional price |
|-----------|------|---|------------------|
|           |      | <b>Special design features</b>                                  |                  |
|           | Z    | Without   | N/C              |
|           | L    | Low power <sup>1)</sup>   | N/C              |
| <b>5</b>  | ?    | Other - please specify  | on inquiry       |
|           |      | <b>Electrical connection</b>                                    |                  |
|           | 2X   | 1/2" NPT male conduit with cable (NEMA 4/IP 67)                 | N/C              |
|           | 3X   | 1/2" NPT male conduit with flying leads (NEMA 4/IP 67)          | \$60.15          |
|           | DX   | ATEX 1/2" male conduit with factory sealed cable (NEMA 4/IP 67) | on inquiry       |
| <b>6</b>  | ??   | Other - please specify  | on inquiry       |
|           |      | <b>Cable length</b>   |                  |
|           | 6    | 6 feet  | N/C              |
| <b>7</b>  | ?    | Other - please specify  | on inquiry       |
|           |      | <b>Approvals</b>  |                  |
|           | 4    | Ex d per ATEX (always with DX)                                  | N/C              |
| <b>8</b>  | 7    | Explosion-proof per FM and CSA (only with 2X, 3X)               | N/C              |
|           |      | <b>Quality certificates</b>                                     |                  |
|           | Z    | Without   | N/C              |
| <b>9</b>  | I    | NIST Certificate of Calibration                                 | \$66.20          |
|           |      | <b>Additional order details</b>                                 |                  |
|           | Z    | Without   | N/C              |
| <b>10</b> | T    | Additional order details  | on inquiry       |

ELECTRONIC PRESSURE

1) Low power only with 1-5 V signal output (supply 6 ...30 V)

TOTAL PRICE

Order Code:

**E-10** -  <sup>1</sup> -  <sup>2</sup>  <sup>3</sup> -  <sup>4</sup> -  <sup>5</sup> **G**  <sup>6</sup>  <sup>7</sup>  <sup>8</sup> -  <sup>9</sup>  <sup>10\*</sup>

\*Additional order details \_\_\_\_\_

# HAZARDOUS AREA

Electronic Pressure > Hazardous Area > E-11

## Type E-11 Explosion-proof Flush Diaphragm Pressure Transmitter Vacuum to 5,000 psi



ELECTRONIC PRESSURE

### Standard features

- **Signal output:** 4-20mA, 2-wire or 1-5 V 3-wire low power
- **Supply voltage:** 10-30 VDC or 6-30 VDC (low power version)
- **Process connection:** Non-clogging flush diaphragm G1B or G1/2B (depending on pressure)
- **Electrical connection:** 1/2" male conduit with cable or flying leads

### E-11 Part Numbers

| Pressure conn.            | G1B or G1/2B <sup>1</sup>              |                 |                       |                 |
|---------------------------|--|-----------------|-----------------------|-----------------|
| Signal output             | 4-20 mA                                |                 | 1-5V 3-wire low power |                 |
| Electrical conn.          | 1/2" NPT male conduit connection with: |                 |                       |                 |
|                           | 6 ft cable*                            | 6 ft leads*     | 6 ft cable            | 6 ft leads*     |
| <b>Compound ranges</b>    |  |                 |                       |                 |
| <b>List price</b>         | <b>\$463.30</b>                        | <b>\$523.45</b> | <b>\$463.30</b>       | <b>\$523.45</b> |
| 30"-0-30 psi <sup>1</sup> | 4373087                                |                 |                       |                 |
| 30"-0-100 psi             |  |                 |                       |                 |
| <b>Gauge ranges</b>       |  |                 |                       |                 |
| <b>List price</b>         | <b>\$427.20</b>                        | <b>\$487.35</b> | <b>\$427.20</b>       | <b>\$487.35</b> |
| 0-15 psi <sup>1</sup>     | <b>4365441</b>                         | <b>4235694</b>  | 4365530               | 4365581         |
| 0-100 psi                 | <b>4365459</b>                         | 4365492         | 4365548               | 4365599         |
| 0-200 psi                 | 4252414                                | 50045954        |                       |                 |
| 0-500 psi                 | <b>50132423</b>                        |                 |                       | <b>4365611</b>  |
| 0-1,000 psi               | 4365467                                | 4365506         | 4365556               | 4365629         |
| 0-1,500 psi               | 50132440                               |                 |                       | 4365637         |
| 0-2,000 psi               | <b>50055712</b>                        |                 | 4365646               |                 |
| 0-3,000 psi               | 4365476                                | 4365514         | 4365565               | 4365654         |
| 0-5,000 psi               | 4365484                                | 4365522         | 4365573               | 4365662         |

<sup>1</sup> G1B for E-11 15 psi and 30inHg vacuum ranges, G1/2B for ranges > 30 psi

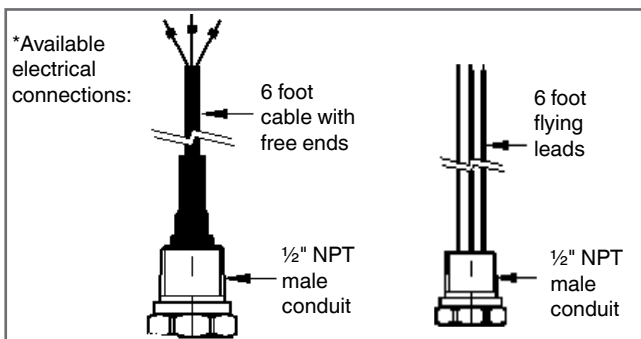

NOTE: Standard items shown in **bold print**. (Subject to prior sale)

Ready-to-ship part numbers are available from stock (subject to prior sale). Items without part numbers are available on special order.

# HAZARDOUS AREA

Electronic Pressure > Hazardous Area > E-11

| E-11 Smart Codes for Custom Order Configurations |                           |   | Base price             | \$427.20   |
|--|---------------------------|---|------------------------|------------|
| Field no.  | Code                      | Feature   | Additional price       |            |
| 1  | <b>Signal output</b>      |   |                        |            |
|  | A                         | 4 ... 20 mA, 2-wire                                 | N/C                    |            |
|  | K                         | 1 ... 5 V, 3-wire                                   | N/C                    |            |
|  | ?                         | Other - please specify                              | on inquiry             |            |
| 2  | <b>Unit</b>               |   |                        |            |
|  | P                         | psi   | N/C                    |            |
|  | 3                         | psi absolute  | \$36.10                |            |
|  | ?                         | Other - please specify                              | on inquiry             |            |
| 3  | <b>Pressure range</b>     |   |                        |            |
|  | CA                        | -30 inHg ... 0                                      | \$36.10                |            |
|  | CD                        | -30 inHg ... 30 psi                                 | \$36.10                |            |
|  | CF                        | -30 inHg ... 60 psi                                 | \$36.10                |            |
|  | CH                        | -30 inHg ... 100 psi                                | \$36.10                |            |
|  | CL                        | -30 inHg ... 200 psi                                | \$36.10                |            |
|  | CN                        | 0 psi ... 5 psi                                     | N/C                    |            |
|  | CP                        | 0 psi ... 10 psi                                    | N/C                    |            |
|  | BC                        | 0 psi ... 15 psi (0 psi ... 15 psi absolute)        | N/C                    |            |
|  | CQ                        | 0 psi ... 25 psi (0 psi ... 25 psi absolute)        | N/C                    |            |
|  | BD                        | 0 psi ... 30 psi                                    | N/C                    |            |
|  | DA                        | 0 psi ... 50 psi (0 psi ... 50 psi absolute)        | N/C                    |            |
|  | BE                        | 0 psi ... 60 psi                                    | N/C                    |            |
|  | BF                        | 0 psi ... 100 psi (0 psi ... 100 psi absolute)      | N/C                    |            |
|  | BG                        | 0 psi ... 160 psi                                   | N/C                    |            |
|  | BH                        | 0 psi ... 200 psi                                   | N/C                    |            |
|  | DG                        | 0 psi ... 250 psi                                   | N/C                    |            |
|  | BI                        | 0 psi ... 300 psi                                   | N/C                    |            |
|  | DI                        | 0 psi ... 500 psi                                   | N/C                    |            |
|  | DJ                        | 0 psi ... 750 psi                                   | N/C                    |            |
|  | BN                        | 0 psi ... 1,000 psi                                 | N/C                    |            |
|  | BO                        | 0 psi ... 1,500 psi                                 | N/C                    |            |
|  | BP                        | 0 psi ... 2,000 psi                                 | N/C                    |            |
|  | BQ                        | 0 psi ... 3,000 psi                                 | N/C                    |            |
|  | BS                        | 0 psi ... 5,000 psi                                 | N/C                    |            |
|  | DS                        | 0 psi ... 8,000 psi                                 | N/C                    |            |
|  |                           | ??  | Other - please specify | on inquiry |
| 4  | <b>Process connection</b> |   |                        |            |
|  | 85                        | G1B, flush diaphragm with O-ring (up to 25 psi)     | N/C                    |            |
|  | 86                        | G1/2B, flush diaphragm with O-ring ( $\geq$ 30 psi) | N/C                    |            |
|  | ?                         | Other - please specify                              | on inquiry             |            |

ELECTRONIC PRESSURE

# HAZARDOUS AREA

Electronic Pressure > Hazardous Area > E-11

ELECTRONIC PRESSURE

## E-11 Smart Codes for Custom Order Configurations (continued)

| Field no.                       | Code | Feature  | Additional Prices |
|---------------------------------|------|--|-------------------|
| <b>Material of wetted parts</b> |      |  |                   |
| 5                               | 1    | Stainless steel and O-ring from NBR                            | N/C               |
|                                 | L    | Stainless steel and O-ring from Viton®                         | \$14.60           |
|                                 | ?    | Other- please specify  | on inquiry        |
| <b>Special design features</b>  |      |  |                   |
| 6                               | Z    | Without  | N/C               |
|                                 | L    | Low power <sup>1)</sup>  | N/C               |
| <b>Electrical connection</b>    |      |  |                   |
| 7                               | 2X   | 1/2" NPT male conduit with free ends (NEMA 4/IP 67)            | N/C               |
|                                 | DX   | 1/2" NPT male conduit with factory sealed cable (NEMA 4 IP 67) | on inquiry        |
|                                 | 3X   | 1/2" NPT male conduit with flying leads (NEMA 4 IP 67)         | \$60.15           |
| <b>Cable length</b>             |      |  |                   |
| 8                               | 6    | 6 feet   | N/C               |
|                                 | ?    | Other- please specify  | on inquiry        |
| <b>Approvals</b>                |      |  |                   |
| 9                               | 4    | Ex d per ATEX (always with DX)                                 | N/C               |
|                                 | 7    | Explosion-proof per FM and CSA (always with 2X, 3X)            | N/C               |
| <b>Quality certificates</b>     |      |  |                   |
| 10                              | Z    | Without  | N/C               |
|                                 | I    | NIST Certificate of Calibration                                | \$66.20           |
| <b>Additional order details</b> |      |  |                   |
| 11                              | Z    | Without  | N/C               |
|                                 | T    | Additional order details                                       | on inquiry        |

1) Low power only with 1-5 V signal output (supply 6 ...30 V)

TOTAL PRICE

Order Code:

1
2
3
4
5
6
7
8
9
10
11\*

**E-11** -  -   -  -   **G**    -

\*Additional order details \_\_\_\_\_

# HAZARDOUS AREA

Electronic Pressure > Hazardous Area > N-10

## Type N-10 Non-incendive Pressure Transmitter Vacuum to 15,000 psi

### Standard features

- **Signal output:** 4-20 mA 2-wire or 1-5 V 3-wire
- **Supply voltage:** 10-30 DC  
(6-30 VDC for 1-5 V version)
- **Process connection:** 1/4 NPT male
- **Electrical connection:** 1/2" NPT male conduit  
with 6 foot cable



ELECTRONIC PRESSURE

### N-10 Part Numbers

| Range           | Description    |                | Price           |
|-----------------|----------------|----------------|-----------------|
|                 | Part #         |                |                 |
|                 | 4-20 mA 2-wire | 1-5 V 3-wire   |                 |
| 30" inHg vacuum | 4348296        | 4354619        | <b>\$391.10</b> |
| 30"-0-30 psi    | <b>4348309</b> | <b>4354627</b> |                 |
| 30"-0-100 psi   | 4332431        | 4354636        |                 |
| 0-15 psi        | <b>4348317</b> | 4354644        | <b>\$355.10</b> |
| 0-30 psi        | <b>4348326</b> | 4354652        |                 |
| 0-60 psi        | 4348334        | 4354660        |                 |
| 0-100 psi       | <b>4348342</b> | <b>4354678</b> |                 |
| 0-200 psi       | <b>4348350</b> | <b>4354686</b> |                 |
| 0-300 psi       | <b>4348368</b> | 4354695        |                 |
| 0-500 psi       | <b>4346216</b> | <b>4354708</b> |                 |
| 0-1,000 psi     | <b>4332440</b> | <b>4354716</b> |                 |
| 0-1,500 psi     | <b>4338597</b> | 4354725        |                 |
| 0-2,000 psi     | <b>4348376</b> | <b>4354733</b> |                 |
| 0-3,000 psi     | <b>4347000</b> | <b>4354741</b> |                 |
| 0-5,000 psi     | <b>4347018</b> | <b>4354759</b> |                 |
| 0-8,000 psi     | 4348385        | 4354767        |                 |
| 0-10,000 psi    | <b>4348393</b> | 4354776        |                 |
| 0-15,000 psi    | <b>4348406</b> | 4354784        |                 |

NOTE: Standard items shown in **bold print**. (Subject to prior sale)

Items without part numbers are available on special order.

# HAZARDOUS AREA

Electronic Pressure > Hazardous Area > N-10

ELECTRONIC PRESSURE

| N-10 Smart Codes for Custom Order Configurations |                                |   | Base price       | \$355.00 |
|--|--------------------------------|---|------------------|----------|
| Field no.  | Code                           | Feature   | Additional price |          |
| 1  | <b>Signal output</b>           |   |                  |          |
|  | A                              | 4 ... 20 mA, 2-wire                               | N/C              |          |
|  | K                              | 1 ... 5 V, 3-wire                                 | N/C              |          |
|  | ?                              | Other - please specify                            | on inquiry       |          |
| 2  | <b>Unit</b>                    |   |                  |          |
|  | P                              | psi   | N/C              |          |
|  | 3                              | psi absolute                                      | \$36.10          |          |
|  | ?                              | Other - please specify                            | on inquiry       |          |
| 3  | <b>Pressure range</b>          |   |                  |          |
|  | CA                             | -30 inHg ... 0                                    | \$36.10          |          |
|  | CD                             | -30 inHg ... 30 psi                               | \$36.10          |          |
|  | CH                             | -30 inHg ... 100 psi                              | \$36.10          |          |
|  | BC                             | 0 psi ... 15 psi (0 psi ... 15 psi absolute)      | N/C              |          |
|  | BD                             | 0 psi ... 30 psi                                  | N/C              |          |
|  | BE                             | 0 psi ... 60 psi                                  | N/C              |          |
|  | BF                             | 0 psi ... 100 psi (0 psi ... 100 psi absolute)    | N/C              |          |
|  | BH                             | 0 psi ... 200 psi                                 | N/C              |          |
|  | BI                             | 0 psi ... 300 psi                                 | N/C              |          |
|  | DI                             | 0 psi ... 500 psi                                 | N/C              |          |
|  | BN                             | 0 psi ... 1,000 psi                               | N/C              |          |
|  | BO                             | 0 psi ... 1,500 psi                               | N/C              |          |
|  | BP                             | 0 psi ... 2,000 psi                               | N/C              |          |
|  | BQ                             | 0 psi ... 3,000 psi                               | N/C              |          |
|  | BS                             | 0 psi ... 5,000 psi                               | N/C              |          |
|  | DS                             | 0 psi ... 8,000 psi                               | N/C              |          |
|  | BT                             | 0 psi ... 10,000 psi                              | N/C              |          |
|  | BU                             | 0 psi ... 15,000 psi                              | N/C              |          |
| ??   | Other - please specify         | on inquiry  |                  |          |
| 4  | <b>Process connection</b>      |   |                  |          |
|  | NB                             | 1/4" NPT  | N/C              |          |
|  | ??                             | Other - please specify                            | on inquiry       |          |
| 5  | <b>Special design features</b> |   |                  |          |
|  | Z                              | Without   | N/C              |          |
|  | L                              | Low power <sup>1)</sup>                           | N/C              |          |
|  | ?                              | Other - please specify                            | on inquiry       |          |
| 6  | <b>Electrical connection</b>   |   |                  |          |
|  | 2X                             | 1/2" NPT male conduit with cable (NEMA 4X/ IP 67) | N/C              |          |
|  | M4                             | 4 Pin locking plug M12x1 (NEMA 4/IP67)            | on inquiry       |          |
|  | ??                             | Other - please specify                            | on inquiry       |          |



# HAZARDOUS AREA

Electronic Pressure > Hazardous Area > N-10

## N-10 Smart Codes for Custom Order Configurations (continued)

| Field no. | Code | Feature   | Additional price |
|-----------|------|---|------------------|
|           |      | <b>Cable length</b>                               |                  |
|           | 6    | 6 feet  | N/C              |
|           | 1    | 10 feet   | \$12.05          |
|           | 2    | 20 feet   | \$36.10          |
|           | 3    | 30 feet   | \$60.15          |
| 7         | ?    | Other - please specify                            | on inquiry       |
|           |      | <b>Approvals</b>                                  |                  |
|           | N    | EEx nA II 3G T6 7 II 3D per ATEX (always with M4) | N/C              |
| 8         | F    | FM, CSA non-incendive (always with 2X)            | N/C              |
|           |      | <b>Quality certificates</b>                       |                  |
|           | Z    | Without   | N/C              |
| 9         | I    | NIST Certificate of Calibration                   | \$66.20          |
|           |      | <b>Additional order details</b>                   |                  |
|           | Z    | Without   | N/C              |
| 10        | T    | Additional order details                          | on inquiry       |

ELECTRONIC PRESSURE

1) Low power only with 1-5 V signal output (supply 6 ...30 V).

TOTAL PRICE

Order Code:

N-10 -  <sup>1</sup> -  <sup>2</sup>  <sup>3</sup> -  <sup>4</sup> -  <sup>5</sup> **G**  <sup>6</sup>  <sup>7</sup>  <sup>8</sup> -  <sup>9</sup>  <sup>10\*</sup>

\*Additional order details \_\_\_\_\_

# HAZARDOUS AREA

Electronic Pressure > Hazardous Area > N-11

## Type N-11 Non-incendive Flush Diaphragm Pressure Transmitter Vacuum to 8,000 psi

ELECTRONIC PRESSURE

### Standard features

- **Signal output:** 4-20 mA 2-wire or 1-5 V 3-wire
- **Supply voltage:** 10-30 DC  
(6-30 VDC for 1-5 V version)
- **Process connection:** G1B or G1/2B flush diaphragm depending on Pressure range
- **Electrical connection:** 1/2" NPT male conduit with 6 foot cable



### N-11 Part Numbers

| Range                 | Description    |              | Price           |
|-----------------------|----------------|--------------|-----------------|
|                       | Part #         |              |                 |
|                       | 4-20 mA 2-wire | 1-5 V 3-wire |                 |
| 30"-0-30 psi          | 4372579        |              | <b>\$427.20</b> |
| 0-15 psi <sup>1</sup> | <b>4354822</b> | 4354792      | <b>\$391.10</b> |
| 0-100 psi             | <b>4358428</b> | 4354806      |                 |
| 0-300 psi             | <b>4364410</b> |              |                 |
| 0-1,000 psi           | 4364690        | 4364428      |                 |
| 0-2,000 psi           | 4358436        | 4354814      |                 |
| 0-3,000 psi           | 4364509        |              |                 |

**NOTES:**

<sup>1</sup>Pressure ranges from 50 inWC to 30 psi are supplied with G1B flush process connections. See datasheet for details.

NOTE: Standard items shown in **bold print**. (Subject to prior sale)

Items without part numbers are available on special order.

# HAZARDOUS AREA

Electronic Pressure > Hazardous Area > N-11

| N-11 Smart Codes for Custom Order Configurations |      |  |                           |
|--|------|--|---------------------------|
| Field no.  | Code | Feature  | Base price                |
|  |      |  | <b>\$391.10</b>           |
|  |      |  | Additional price          |
|  |      | <b>Signal output</b>                                     |                           |
| 1  | A    | 4 ... 20 mA, 2-wire                                      | N/C                       |
|  | K    | 1 ... 5 V, 3-wire  | N/C                       |
|  | ?    | Other - please specify                                   | on inquiry                |
|  |      | <b>Unit</b>  |                           |
| 2  | P    | psi  | N/C                       |
|  | 3    | psi absolute   | \$36.10                   |
|  | ?    | Other - please specify                                   | on inquiry                |
|  |      | <b>Pressure range</b>                                    |                           |
| 3  | CA   | -30 inHg ... 0   | \$36.10                   |
|  | CD   | -30 inHg ... 30 psi                                      | \$36.10                   |
|  | CH   | -30 inHg ... 100 psi                                     | \$36.10                   |
|  | BC   | 0 psi ... 15 psi (0 psi ... 15 psi absolute)             | N/C                       |
|  | BD   | 0 psi ... 30 psi   | N/C                       |
|  | BE   | 0 psi ... 60 psi   | N/C                       |
|  | BF   | 0 psi ... 100 psi (0 psi ... 100 psi absolute)           | N/C                       |
|  | BH   | 0 psi ... 200 psi  | N/C                       |
|  | BI   | 0 psi ... 300 psi  | N/C                       |
|  | DI   | 0 psi ... 500 psi  | N/C                       |
|  | BN   | 0 psi ... 1,000 psi                                      | N/C                       |
|  | BO   | 0 psi ... 1,500 psi                                      | N/C                       |
|  | BP   | 0 psi ... 2,000 psi                                      | N/C                       |
|  | BQ   | 0 psi ... 3,000 psi                                      | N/C                       |
|  | BS   | 0 psi ... 5,000 psi                                      | N/C                       |
|  | DQ   | 0 psi ... 6,000 psi                                      | N/C                       |
|  | DR   | 0 psi ... 7,500 psi                                      | N/C                       |
|  | DS   | 0 psi ... 8,000 psi                                      | N/C                       |
|  | ??   | Other - please specify                                   | on inquiry                |
|  |      |  | <b>Process connection</b> |
| 4  | 85   | G1B, flush diaphragm with O-ring (50 inWC to 25 psi)     | N/C                       |
|  | 86   | G1/2B, flush diaphragm with O-ring (30 psi to 5,000 psi) | N/C                       |
|  |      | <b>Material of wetted parts</b>                          |                           |
| 5  | 1    | Stainless steel and O-ring from NBR                      | N/C                       |
|  | B    | Stainless steel and O-ring from EPDM                     | N/C                       |
|  | L    | Stainless steel and O-ring from Viton®                   | \$13.25                   |
|  | ?    | Other- please specify                                    | on inquiry                |
|  |      | <b>Special design features</b>                           |                           |
| 6  | Z    | Without  | N/C                       |
|  | L    | Low power <sup>1)</sup>                                  | N/C                       |
|  |      | <b>Electrical connection</b>                             |                           |
| 7  | 2X   | 1/2" NPT male conduit with cable (NEMA 4X / IP 67)       | N/C                       |
|  | M4   | 4 Pin locking plug M12x1 (NEMA 4/IP67)                   | on inquiry                |
|  | ??   | Other- please specify                                    | on inquiry                |

ELECTRONIC PRESSURE

# HAZARDOUS AREA

Electronic Pressure > Hazardous Area > N-11

ELECTRONIC PRESSURE

| N-11 Smart Codes for Custom Order Configurations (continued) |                                 |   |                  |
|--|---------------------------------|---|------------------|
| Field no.  | Code                            | Feature   | Additional price |
| 8  | <b>Cable length</b>             |   |                  |
|  | 6                               | 6 feet  | N/C              |
|  | 1                               | 10 feet   | \$12.05          |
|  | 2                               | 20 feet   | \$36.10          |
|  | 3                               | 30 feet   | \$60.15          |
| 9  | <b>Approvals</b>                |   |                  |
|  | N                               | EEx nA II 3G T6 7 II 3D per ATEX (always with M4) | N/C              |
|  | F                               | FM, CSA non-incendive (always with 2X)            | N/C              |
| 10   | <b>Quality certificates</b>     |   |                  |
|  | Z                               | Without   | N/C              |
|  | I                               | NIST Certificate of Calibration                   | \$66.20          |
| 11   | <b>Additional order details</b> |   |                  |
|  | Z                               | Without   | N/C              |
|  | T                               | Additional order details                          | on inquiry       |

1) Low power only available with 1-5 V signal output (supply 6 ...30 V)

TOTAL PRICE

Order Code:    1       2    3       4       5    6       7    8    9       10   11\*

**N-11** -  -  -  -  **G**  -

\*Additional order details \_\_\_\_\_

# HAZARDOUS AREA

Electronic Pressure > Hazardous Area > IS-20

## Type IS-20 Intrinsically Safe Pressure Transmitter

### Standard features

- **Signal output:** 4-20 mA 2-wire
- **Supply voltage:** 10-30 VDC
- **Process connection:** 1/2 NPT Male
- **Electrical connection:** DIN EN 175301-803 (DIN 43 650) with 1/2" NPT female conduit plug connector

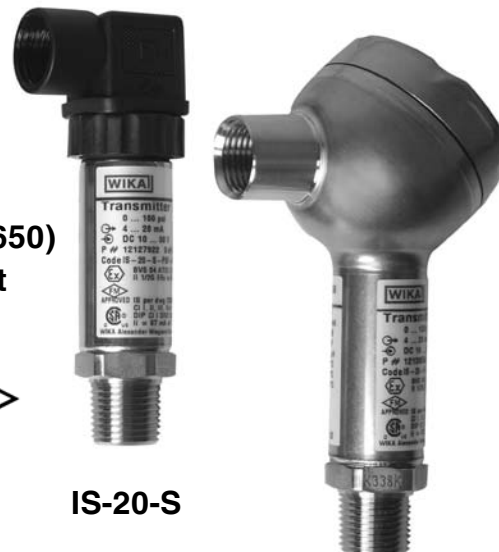

IS-20-S

IS-20-F

ELECTRONIC PRESSURE

### IS-20-S Part Numbers

| Gauge Ranges |                 |          |
|--------------|-----------------|----------|
| Description  |                 |          |
| Range        | Part #          | Price    |
| 0-5 psi      | 12127851        | \$483.15 |
| 0-10 psi     | 12127877        |          |
| 0-15 psi     | <b>12127885</b> |          |
| 0-25 psi     | 12127893        |          |
| 0-30 psi     | 12127906        |          |
| 0-60 psi     | <b>12127914</b> |          |
| 0-100 psi    | <b>12127922</b> |          |
| 0-160 psi    | <b>12127940</b> |          |
| 0-200 psi    | <b>12127966</b> |          |
| 0-300 psi    | <b>12127974</b> |          |
| 0-500 psi    | <b>12127982</b> |          |
| 0-1,000 psi  | <b>12128040</b> |          |
| 0-1,500 psi  | <b>12128058</b> |          |
| 0-2,000 psi  | 12128066        |          |
| 0-3,000 psi  | <b>12128074</b> |          |
| 0-5,000 psi  | <b>12128104</b> |          |
| 0-8,000 psi  | 12128112        |          |
| 0-10,000 psi | <b>12128121</b> |          |

NOTE: Standard items shown in **bold print**. (Subject to prior sale)

| Vacuum & Compound Range |                 |          |
|-------------------------|-----------------|----------|
| Description             |                 |          |
| Range                   | Part #          | Price    |
| 30 inHg vac             | <b>12127796</b> | \$569.20 |
| 30 inHg/30 psi          | 12127833        |          |
| 30 inHg/60 psi          | 12127841        |          |

| Absolute Pressure Ranges |                 |          |
|--------------------------|-----------------|----------|
| Description              |                 |          |
| Range                    | Part #          | Price    |
| 0-100 psia               | <b>12128147</b> | \$569.20 |

| Gauge Ranges  |                 |          |
|---------------|-----------------|----------|
| Description   |                 |          |
| Range         | Part #          | Price    |
| 0 - 100 psi   | 12128554        | \$642.00 |
| 0 - 1,000 psi | <b>12128687</b> |          |
| 0 - 3,000 psi | 12128732        |          |

# HAZARDOUS AREA

Electronic Pressure > Hazardous Area > IS-20

## IS-20 Smart Codes for Custom Order Configurations

| Field no. | Code   | Feature  | Base price       |            |
|-----------|--|--|------------------|------------|
| 1         | <b>Model</b>                                 |  |                  |            |
|           | S  | Standard version                               | \$483.15         |            |
|           | F  | With integral junction Box                     |                  | \$642.00   |
|           | H  | High pressure version                          |                  | \$1,972.00 |
| 2         | <b>Unit</b>                                  |  | Additional price |            |
|           | P  | psi  | N/C              |            |
|           | N  | InWC   | N/C              | -          |
|           | 3  | psi absolute                                   | \$86.05          | -          |
|           | ?  | Other - please specify                         | on inquiry       | -          |
| 3         | <b>Pressure range</b>                        |  |                  |            |
|           | CA   | -30 inHg ... 0                                 | \$86.05          | -          |
|           | CD   | -30 inHg ... 30 psi                            | \$86.05          | -          |
|           | CF   | -30 inHg ... 60 psi                            | \$86.05          | -          |
|           | CH   | -30 inHg ... 100 psi                           | \$86.05          | -          |
|           | CK   | -30 inHg ... 160 psi                           | \$86.05          | -          |
|           | CL   | -30 inHg ... 200 psi                           | \$86.05          | -          |
|           | GG   | 0 InWC ... 50 InWC                             | N/C              | -          |
|           | GU   | 0 InWC ... 100 InWC                            | N/C              | -          |
|           | CN   | 0 psi ... 5 psi                                | N/C              | -          |
|           | CP   | 0 psi ... 10 psi                               | N/C              | -          |
|           | BC   | 0 psi ... 15 psi (0 psi ... 15 psi absolute)   | N/C              | -          |
|           | CQ   | 0 psi ... 25 psi (0 psi ... 25 psi absolute)   | N/C              | -          |
|           | BD   | 0 psi ... 30 psi                               | N/C              | -          |
|           | DA   | 0 psi ... 50 psi (0 psi ... 50 psi absolute)   | N/C              | -          |
|           | BE   | 0 psi ... 60 psi                               | N/C              | -          |
|           | BF   | 0 psi ... 100 psi (0 psi ... 100 psi absolute) | N/C              | -          |
|           | BG   | 0 psi ... 160 psi                              | N/C              | -          |
|           | BH   | 0 psi ... 200 psi                              | N/C              | -          |
|           | DG   | 0 psi ... 250 psi (0 psi ... 250 psi absolute) | N/C              | -          |
|           | BI   | 0 psi ... 300 psi                              | N/C              | -          |
|           | BK   | 0 psi ... 400 psi                              | N/C              | -          |
|           | DI   | 0 psi ... 500 psi                              | N/C              | -          |
|           | BL   | 0 psi ... 600 psi                              | N/C              | -          |
|           | DJ   | 0 psi ... 750 psi                              | N/C              | -          |
|           | BN   | 0 psi ... 1,000 psi                            | N/C              | -          |
|           | BO   | 0 psi ... 1,500 psi                            | N/C              | -          |
|           | BP   | 0 psi ... 2,000 psi                            | N/C              | -          |
|           | BQ   | 0 psi ... 3,000 psi                            | N/C              | -          |
|           | BS   | 0 psi ... 5,000 psi                            | N/C              | -          |
|           | DS   | 0 psi ... 8,000 psi                            | N/C              | -          |
|           | BT   | 0 psi ... 10,000 psi                           | N/C              | -          |
| BU        | 0 psi ... 15,000 psi                         | N/C  | -                |            |
| ??        | Other-up to maximum specified pressure range | on inquiry                                     | -                |            |
|           | 0 psi ... 25,000 psi                         | -  | on inquiry       |            |
|           | 0 psi ... 60,000 psi                         | -  | on inquiry       |            |
|           | 0 psi ... 75,000 psi                         | -  | on inquiry       |            |
|           | 0 psi ... 85,000 psi                         | -  | on inquiry       |            |
|           | 0 psi ... 100,000 psi                        | -  | on inquiry       |            |
|           | 0 psi ... 115,000 psi                        | -  | on inquiry       |            |

# HAZARDOUS AREA

Electronic Pressure > Hazardous Area > IS-20

## IS-20 Smart Codes for Custom Order Configurations (continued)

Field no. Code Feature

|   |    | Additional price   |            |                    |
|---|----|--|------------|--------------------|
|   |    | <b>Process connection</b>  |            |                    |
|   | GB | G 1/4 B  | N/C        | -                  |
|   | GD | G 1/2 B  | N/C        | -                  |
|   | NB | 1/4 NPT  | N/C        | -                  |
|   | ND | 1/2 NPT  | N/C        | -                  |
|   | CS | Diaphragm seal - <i>price see diaphragm seal</i>                                   | N/C        | -                  |
|   | ML | M16 x 1.5 female, w/sealing cone<br><i>only for pressure range over 24,000 psi</i> | -          | N/C                |
|   | VZ | 9/16 - 18 UNF female F250-C<br><i>only for pressure range over 24,000 psi</i>      | -          | N/C                |
|   | MP | M20 x 1.5 female, w/sealing cone<br><i>only for pressure range over 24,000 psi</i> | -          | N/C                |
| 4 | ?? | Other - please specify   | on inquiry | -                  |
|   |    | <b>Special design features</b>   |            |                    |
|   | Z  | Without  | N/C        |                    |
|   | G  | Suitable for food  | \$59.60    | -                  |
|   | A  | Oxygen, oil and grease free <sup>1)</sup>  | on inquiry | -                  |
| 5 | ?  | Other - please specify   | on inquiry | -                  |
|   |    | <b>Accuracy</b>  |            |                    |
|   | G  | +/- 0.25% B.F.S.L.   | N/C        |                    |
| 6 | K  | +/- 0.125% B.F.S.L. (≥ 100 inWC)   | \$46.35    | -                  |
|   |    | <b>Electrical connection</b>   |            |                    |
|   | AX | 4 Pin L-plug DIN 43 650 with 1/2" NPT female conduit (NEMA 5/IP 65)                | N/C        | - N/C              |
|   | A4 | 4 Pin L-plug DIN 43 650 with Pg 9 (NEMA 5 / IP 65)                                 | \$6.10     | - \$6.10           |
|   | DL | Cable with free ends (NEMA 4 / IP 67)  | \$63.55    | - \$63.55          |
|   | XM | Submersible cable (NEMA 6 / IP 68)   | \$165.50   | - \$165.50         |
|   | O4 | 4 Pin MIL plug PT02E-8-4P (NEMA 5 / IP 65)   | \$86.05    | - \$86.05          |
|   | C6 | 6 Pin MIL plug PT02E-10-6P (NEMA 5 / IP 65)  | \$86.05    | - \$86.05          |
|   | FE | 1/2" NPT female conduit (IP67)   | -          | N/C \$112.55       |
|   | FH | Nickel plated brass cable gland (IP68)   | -          | N/C \$112.55       |
|   | FC | Stainless steel cable gland (IP68)   | -          | \$39.75 \$1,331.00 |
| 7 | ?? | Other - please specify   | on inquiry |                    |
|   |    | <b>Cable length</b>  |            |                    |
|   | Z  | Without (always with plug connection)  | N/C        |                    |
|   | Y  | 5 feet   | N/C        | - N/C              |
|   | 1  | 10 feet  | \$13.25    | - \$13.25          |
|   | 2  | 20 feet  | \$39.75    | - \$39.75          |
|   | 3  | 30 feet  | \$66.20    | - \$66.20          |
|   | 4  | 40 feet  | \$92.65    | - \$92.65          |
|   | 5  | 50 feet  | \$119.15   | - \$119.15         |
| 8 | ?  | Other - please specify   | on inquiry |                    |
|   |    | <b>Temperature range of medium</b>   |            |                    |
|   | U  | -20 ... +80 °C (-4 ... +176 °F)  | N/C        |                    |
|   | 8  | -40 ... +150 °C (-40 ... +302 °F)  | \$105.90   | -                  |
| 9 | 9  | -40 ... +200 °C (-40 ... +392 °F)  | \$158.80   | -                  |

# HAZARDOUS AREA

Electronic Pressure > Hazardous Area > IS-20

ELECTRONIC PRESSURE

## IS-20 Smart Codes for Custom Order Configurations (continued)

| Field no. | Code | Feature  | Additional price |   |     |
|-----------|------|--|------------------|---|-----|
| 10        |      | <b>SIL2</b>  |                  |   |     |
|           | Z    | Without  | N/C              |   |     |
|           | S    | SIL2 according to IEC61508 / IEC61511  | \$61.30          |   |     |
| 11        |      | <b>Approvals</b>   |                  |   |     |
|           | 1    | EEx ia I M1 + 1/2G, 2G incl. FM, CSA & ATEX                                  | N/C              |   |     |
|           | A    | EEx ia II C T6 1/2G, 2G per ATEX incl. FM & CSA <sup>2)</sup>                | N/C              |   |     |
|           | D    | EEx IP6X 1/2D, 2D + 1/2 G, 2G +M1 per ATEX incl. FM and CSA <sup>3) 4)</sup> | N/C              | - | N/C |
|           | S    | EEx ia II C T6 1/2G per ATEX incl. FM, CSA and ship approval GL              | \$52.95          |   | -   |
|           |      | <b>Quality certificates</b>  |                  |   |     |
| 12        | Z    | Without  | N/C              |   |     |
|           | I    | NIST Certificate of Calibration (always with 0.125% accuracy)                | \$72.80          |   |     |
| 13        |      | <b>Digital display</b>   |                  |   |     |
|           | Z    | Without  | N/C              |   |     |
|           | 1    | Digital display (order separately)   | on inquiry       |   |     |
| 14        |      | <b>Additional order details</b>  |                  |   |     |
|           | Z    | Without  | N/C              |   |     |
|           | T    | Additional order details   | on inquiry       |   |     |

**NOTES:**

- 1) Maximum media temperature is -4 ... +140° F (-20 ... +60° C)  
Pressure ranges 100 InWC to 300 psi (Field 5, Code A)
- 2) Only available in MIL Plug version (Field 7, Codes O4 and C6)
- 3) Only available in IP68 version
- 4) Maximum media temperature is -4 ... +176° F (-20 ... +80° C) (Field 9, Code U)

TOTAL PRICE

Order Code:

1    2    3    4    5    6    7    8    9    10    11    12    13    14\*  
**IS-20** -  -   -  - **A**        -

\*Additional order details \_\_\_\_\_



# HAZARDOUS AREA

Electronic Pressure > Hazardous Area > IS-21

## Type IS-21 Intrinsically Safe Flush Diaphragm Pressure Transmitter

### Standard features

- **Signal output:** 4-20 mA 2-wire
- **Supply voltage:** 10-30 DC
- **Process connection:** G1B or G1/2B depending upon pressure range
- **Electrical connection:** DIN EN 175301-803 (DIN 43 650) with 1/2" NPT female conduit plug connector



ELECTRONIC PRESSURE

### IS-21-S Part Numbers

| Gauge Ranges          |                 |                 |
|-----------------------|-----------------|-----------------|
| Description           |                 |                 |
| Range                 | Part #          | Price           |
| 0-5 psi <sup>1</sup>  | 12128252        | <b>\$549.30</b> |
| 0-10 psi <sup>1</sup> | 12128287        |                 |
| 0-15 psi <sup>1</sup> | 12128295        |                 |
| 0-30 psi <sup>1</sup> | 12128325        |                 |
| 0-50 psi              | 12128333        |                 |
| 0-100 psi             | <b>12128368</b> |                 |
| 0-1,000 psi           | 12128376        |                 |
| 0-3,000 psi           | 12128481        |                 |
| 0-5,000 psi           | 12128503        |                 |
| 0-8,000 psi           | 12128538        |                 |

NOTE:

<sup>1</sup>Pressure ranges from 50 inWC to 30 PSI are supplied with G1B flush process connections; see datasheet for details

NOTE: Standard items shown in **bold print**. (Subject to prior sale)

# HAZARDOUS AREA

Electronic Pressure > Hazardous Area > IS-21

ELECTRONIC PRESSURE

| IS-21 Smart Codes for Custom Order Configurations |      |  |                  |
|---|------|--|------------------|
| Field no.   | Code | Feature  | Base price       |
| 1   |      | <b>Model</b>                                   |                  |
|   | S    | Standard version                               | \$549.30         |
|   | F    | Field case / integral junction box             | \$708.20         |
| 2   |      | <b>Unit</b>                                    | Additional price |
|   | P    | psi  | N/C              |
|   | N    | InWC   | N/C              |
|   | 3    | psi absolute (from 15 psi to 250 psi absolute) | \$86.05          |
|   | ?    | Other - please specify                         | on inquiry       |
| 3   |      | <b>Pressure range</b>                          |                  |
|   | CA   | -30 inHg ... 0                                 | \$86.05          |
|   | CD   | -30 inHg ... 30 psi                            | \$86.05          |
|   | CF   | -30 inHg ... 60 psi                            | \$86.05          |
|   | CH   | -30 inHg ... 100 psi                           | \$86.05          |
|   | CK   | -30 inHg ... 160 psi                           | \$86.05          |
|   | CL   | -30 inHg ... 200 psi                           | \$86.05          |
|   | GG   | 0 InWC ... 50 InWC                             | N/C              |
|   | GU   | 0 InWC ... 100 InWC                            | N/C              |
|   | CN   | 0 psi ... 5 psi                                | N/C              |
|   | CP   | 0 psi ... 10 psi                               | N/C              |
|   | BC   | 0 psi ... 15 psi (0 psi ... 15 psi absolute)   | N/C              |
|   | CQ   | 0 psi ... 25 psi (0 psi ... 25 psi absolute)   | N/C              |
|   | BD   | 0 psi ... 30 psi                               | N/C              |
|   | DA   | 0 psi ... 50 psi (0 psi ... 50 psi absolute)   | N/C              |
|   | BE   | 0 psi ... 60 psi                               | N/C              |
|   | BF   | 0 psi ... 100 psi (0 psi ... 100 psi absolute) | N/C              |
|   | BG   | 0 psi ... 160 psi                              | N/C              |
|   | BH   | 0 psi ... 200 psi                              | N/C              |
|   | DG   | 0 psi ... 250 psi (0 psi ... 250 psi absolute) | N/C              |
|   | BI   | 0 psi ... 300 psi                              | N/C              |
|   | DI   | 0 psi ... 500 psi                              | N/C              |
|   | BL   | 0 psi ... 600 psi                              | N/C              |
|   | DJ   | 0 psi ... 750 psi                              | N/C              |
|   | BN   | 0 psi ... 1,000 psi                            | N/C              |
|   | BO   | 0 psi ... 1,500 psi                            | N/C              |
|   | BP   | 0 psi ... 2,000 psi                            | N/C              |
|   | BQ   | 0 psi ... 3,000 psi                            | N/C              |
|   | BS   | 0 psi ... 5,000 psi                            | N/C              |
|   | DS   | 0 psi ... 8,000 psi                            | N/C              |
|   | ?3   | Other-up to maximum specified pressure range   | on inquiry       |

# HAZARDOUS AREA

Electronic Pressure > Hazardous Area > IS-21

## IS-21 Smart Codes for Custom Order Configurations (continued)

Field no. Code Feature

|   |                                 | Additional price  |            |
|---|---------------------------------|---|------------|
| 4 | <b>Process connection</b>       |   |            |
|   | 85                              | G 1 B, flush diaphragm with O-ring (up to 25 psi)                     | N/C        |
|   | 86                              | G 1/2 B, flush diaphragm with O-ring (≥ 30 psi)                       | N/C        |
|   | ??                              | Other - please specify  | on inquiry |
| 5 | <b>Material of wetted parts</b> |   |            |
|   | 1                               | Stainless steel, NBR O-ring <sup>1)</sup>                             | N/C        |
|   | L                               | Stainless steel, Viton® O-ring  | \$14.60    |
|   | S                               | Hastelloy® C4, Viton® O-ring  | \$238.30   |
|   | ?                               | Other - please specify  | on inquiry |
| 6 | <b>Special design features</b>  |   |            |
|   | Z                               | Without   | N/C        |
|   | G                               | Suitable for food   | \$59.60    |
|   | ?                               | Other - please specify  | on inquiry |
| 7 | <b>Accuracy</b>                 |   |            |
|   | G                               | +/- 0.25% B.F.S.L.  | N/C        |
|   | K                               | +/- 0.125% B.F.S.L. (≥ 100 inWC)                                      | \$46.35    |
| 8 | <b>Electrical connection</b>    |   |            |
|   | A4                              | 4 Pin L-plug DIN 43 650 with pg 9 (NEMA 5 / IP 65)                    | N/C        |
|   | AX                              | 4 Pin L-plug DIN 43 650 with 1/2" NPT female conduit (NEMA 5 / IP 65) | \$6.10     |
|   | DL                              | Cable with free ends (NEMA 4 / IP 67)                                 | \$63.55    |
|   | XM                              | Submersible cable (NEMA 6 / IP 68)                                    | \$165.50   |
|   | O4                              | 4 Pin MIL Plug PT02E-8-4P (NEMA 5 / IP 65)                            | \$86.05    |
|   | C6                              | 6 Pin MIL Plug PT02E-10-6P (NEMA 5 / IP 65)                           | \$86.05    |
|   | FE                              | 1/2" NPT female conduit (IP67)  | -          |
|   | FH                              | Nickel plated brass cable gland (IP68)                                | -          |
|   | FC                              | Stainless steel cable gland (IP68)                                    | -          |
|   | ??                              | Other - please specify  | on inquiry |
|   | 9                               | <b>Cable length</b>   |            |
| Z |                                 | Without (always with plug version)                                    | N/C        |
| Y |                                 | 5 feet  | N/C        |
| 1 |                                 | 10 feet   | \$13.25    |
| 2 |                                 | 20 feet   | \$39.75    |
| 3 |                                 | 30 feet   | \$66.20    |
| 4 |                                 | 40 feet   | \$92.65    |
| 5 |                                 | 50 feet   | \$119.15   |
| ? |                                 | Other - please specify  | on inquiry |

# HAZARDOUS AREA

Electronic Pressure > Hazardous Area > IS-21

ELECTRONIC PRESSURE

## IS-21 Smart Codes for Custom Order Configurations (continued)

| Field no. | Code | Feature   | Additional price |
|-----------|------|---|------------------|
|           |      | <b>Temperature range of medium</b>  |                  |
| 10        | U    | -20 ... +80 °C (-4 ... +176 °F)   | N/C              |
|           | C    | -20 ... +150 °C (-4 ... +302 °F) with cooling element                           | on inquiry       |
|           |      | <b>SIL2</b>   |                  |
| 11        | Z    | Without   | N/C              |
|           | S    | SIL2 according to IEC61508 / IEC61511   | \$61.30          |
|           |      | <b>Approvals</b>  |                  |
| 12        | 1    | EEx ia I M1 + 1/2G, 2G incl. FM, CSA & ATEX                                     | N/C              |
|           | A    | EEx ia II C T6 1/2G, 2G per ATEX incl. FM & CSA <sup>2)</sup>                   | N/C              |
|           | D    | EEx IP6X 1/2D, 2D + 1/2 G, 2G +M1<br>per ATEX incl. FM and CSA <sup>3) 4)</sup> | N/C              |
|           | S    | EEx ia II C T6 1/2G per ATEX<br>incl. FM, CSA and ship approval GL              | \$52.95          |
|           |      | <b>Quality certificates</b>   |                  |
| 13        | Z    | Without   | N/C              |
|           | I    | NIST Certificate of Calibration (always with 0.125% accuracy)                   | \$72.80          |
|           | ?    | Other - please specify  | on inquiry       |
|           |      | <b>Digital display</b>  |                  |
| 14        | Z    | Without   | N/C              |
|           | 1    | Digital display (order separately)  | on inquiry       |
|           |      | <b>Additional order details</b>   |                  |
| 15        | Z    | Without   | N/C              |
|           | T    | Additional order details  | N/C              |

**NOTES:**

- 1) Not available with cooling element option (Field 10, Code C)
- 2) Only available in MIL Plug version (Field 8, Codes O4 and C6)
- 3) Only available in IP68 version
- 4) Maximum media temperature is -4 ... +176°F (-20 ... +80°C) (Field 10, Code U)

TOTAL PRICE

Order Code:    1    2    3    4    5    6    7    8    9    10    11    12    13    14    15\*

**IS-21** -  -  -  - **A**  -

\*Additional order details \_\_\_\_\_

# HAZARDOUS AREA

Electronic Pressure > Hazardous Area > IS-20-VR

## Type IS-20-VR Hazardous Area Pressure Transmitter for Low Pressure Applications

### Standard features

- **Signal output:** 4-20 mA 2-wire
- **Supply voltage:** 10-30 VDC
- **Process connection:** 1/2" NPT Male with enlarged port
- **Electrical connection:** 1/2" NPT Male conduit with 5 ft. cable



ELECTRONIC PRESSURE

### IS-20-VR Part Numbers

| Gauge Ranges                  |          |          |
|-------------------------------|----------|----------|
| Description                   |          |          |
| Range                         | Part #   | Price    |
| 0 ... 12 oz / in <sup>2</sup> | 14034850 | \$653.30 |
| 0 ... 16 oz / in <sup>2</sup> | 13464541 |          |

| Compound Range                        |          |          |
|---------------------------------------|----------|----------|
| Description                           |          |          |
| Range                                 | Part #   | Price    |
| -4 ... 0 ... +12 oz / in <sup>2</sup> | 14034851 | \$653.30 |

# SUBMERSIBLE LIQUID LEVEL

Electronic Pressure > Submersible Liquid Level > LS-10

## Type LS-10 Submersible Liquid Level Transmitter 100 InWC to 100 psi

See pages 196 and 197 for additional accessories for this item.

### Standard features

- **Signal output:** 4-20 mA 2-wire
- **Supply voltage:** 10-30 VDC
- **Process connection:** G1/2B with removable protective cap
- **Electrical connection:** Vented polyurethane cable  
(must specify length)

**Important Ordering Instructions:** Specify the level transmitter part number and cable length part number corresponding to the total required cable length. For example, a 100 InWC level transmitter with 40 feet of cable should be ordered as 4262761/4347931 with a list price of \$539.45



ELECTRONIC PRESSURE

**Pressure range part number AND cable length part number must be specified on every order!**

### Cable Length Part Numbers

| Cable Length Selector |         |          |          |         |          |   |         |          |
|-----------------------|---------|----------|----------|---------|----------|---|---------|----------|
| Length                | Part#   | Price    | Length   | Part #  | Price    | Length                                    | Part #  | Price    |
| 5 feet                | 4347868 | included | 60 feet  | 4347974 | \$182.00 | 130 feet                                  | 4348075 | \$413.70 |
| 10 feet               | 4347876 | \$16.55  | 65 feet  | 4347982 | \$198.55 | 140 feet                                  | 4348083 | \$446.75 |
| 15 feet               | 4347885 | \$33.10  | 70 feet  | 4347990 | \$215.10 | 150 feet                                  | 4348091 | \$479.85 |
| 20 feet               | 4347893 | \$49.65  | 75 feet  | 4348006 | \$231.65 | 160 feet                                  | 4348105 | \$512.95 |
| 25 feet               | 4347906 | \$66.20  | 80 feet  | 4348016 | \$248.20 | 170 feet                                  | 4348113 | \$545.95 |
| 30 feet               | 4347915 | \$82.75  | 85 feet  | 4348024 | \$264.75 | 180 feet                                  | 4348121 | \$579.10 |
| 35 feet               | 4347923 | \$99.30  | 90 feet  | 4348032 | \$281.30 | 190 feet                                  | 4348139 | \$612.20 |
| 40 feet               | 4347931 | \$115.80 | 95 feet  | 4360903 | \$297.85 | 200 feet                                  | 4348147 | \$645.30 |
| 45 feet               | 4347949 | \$132.40 | 100 feet | 4348040 | \$314.45 | 250 feet                                  | 4364479 | \$810.80 |
| 50 feet               | 4347957 | \$148.95 | 110 feet | 4348058 | \$240.40 | 300 feet                                  | 4366340 | \$976.30 |
| 55 feet               | 4347966 | \$165.50 | 120 feet | 4348066 | \$380.55 | Contact factory for lengths over 300 feet |         |          |

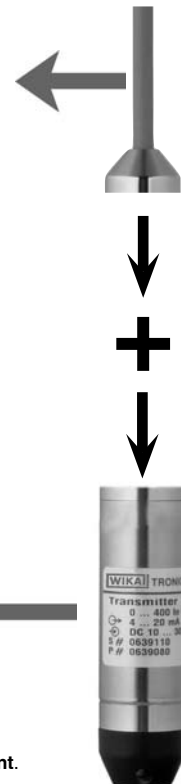

### LS-10 Standard Ranges

| Gauge Ranges |                |                 |
|--------------|----------------|-----------------|
| Description  |                |                 |
| Range        | Part #         | Price           |
| 0-100 inWC   | <b>4262761</b> | <b>\$462.00</b> |
| 0-150 inWC   | <b>4262779</b> |                 |
| 0-250 inWC   | <b>4262787</b> |                 |
| 0-400 inWC   | <b>4262795</b> |                 |
| 0-5 psi      | <b>4262809</b> |                 |
| 0-10 psi     | <b>4262817</b> |                 |
| 0-15 psi     | <b>4262825</b> |                 |
| 0-25 psi     | <b>4262833</b> |                 |
| 0-30 psi     | <b>4262841</b> |                 |
| 0-50 psi     | <b>4262850</b> |                 |
| 0-100 psi    | <b>4262868</b> |                 |

NOTE: Stock items shown in bold print.

NOTE: LS-10 "Ready-to-Ship" submersible transmitters require assembly from factory stocked components and usually ship in three days or less.

# SUBMERSIBLE LIQUID LEVEL

Electronic Pressure > Submersible Liquid Level > LH-10

## Type LH-10 Submersible High Performance Liquid Level Transmitter 50 InWC to 400 psi

### Standard features

- **Signal output:** 4-20 mA 2-wire
- **Supply voltage:** 10-30 VDC
- **Process connection:** G1/2B with removable protective cap
- **Electrical connection:** 40 ft. vented polyurethane cable

### LH-10 Part Numbers

| Gauge Ranges |                |                 |
|--------------|----------------|-----------------|
| Description  |                |                 |
| Range        | Part #         | Price           |
| 0-50 inWC    | <b>9699703</b> | <b>\$655.25</b> |
| 0-100 inWC   | <b>9699711</b> |                 |
| 0-150 inWC   | <b>9699729</b> |                 |
| 0-250 inWC   | 9699737        |                 |
| 0-400 inWC   | 9699745        |                 |
| 0-5 psi      | <b>8371846</b> |                 |
| 0-10 psi     | <b>9699754</b> |                 |
| 0-15 psi     | <b>9736225</b> |                 |
| 0-25 psi     | 9699762        |                 |
| 0-50 psi     | 9699770        |                 |
| 0-100 psi    | 9699788        |                 |

Ready-to-ship part numbers in **bold print** are available from stock (subject to prior sale). Items without part numbers are available on special order.



ELECTRONIC PRESSURE

# SUBMERSIBLE LIQUID LEVEL

Electronic Pressure > Submersible Liquid Level > LH-10

ELECTRONIC PRESSURE

| LH-10 Smart Codes for Custom Order Configurations |                                |  | Base price       | \$538.40 |  |
|---|--------------------------------|--|------------------|----------|--|
| Field no.   | Code                           | Feature  | Additional price |          |  |
| 1   | <b>Signal output</b>           |  |                  |          |  |
|   | A                              | 4 ... 20 mA, 2-wire  | N/C              |          |  |
|   | B                              | 0 ... 20 mA, 3-wire  | \$86.05          |          |  |
|   | F                              | 0 ... 10 V, 3-wire (Supply 14-30 V)                          | \$86.05          |          |  |
|   | G                              | 0 ... 5 V, 3-wire  | \$86.05          |          |  |
|   | S                              | 0.5 ... 2.5 V, 3-wire  | \$86.05          |          |  |
| ?   | Other - please specify         | on inquiry   |                  |          |  |
| 2   | <b>Unit</b>                    |  |                  |          |  |
|   | P                              | psi  | N/C              |          |  |
|   | N                              | InWC   | N/C              |          |  |
|   | ?                              | Other - please specify                                       | on inquiry       |          |  |
| 3   | <b>Pressure range</b>          |  |                  |          |  |
|   | GG                             | 0 InWC ... 50 InWC   | N/C              |          |  |
|   | GU                             | 0 InWC ... 100 InWC  | N/C              |          |  |
|   | GV                             | 0 InWC ... 150 InWC  | N/C              |          |  |
|   | GW                             | 0 InWC ... 250 InWC  | N/C              |          |  |
|   | GX                             | 0 InWC ... 400 InWC  | N/C              |          |  |
|   | CN                             | 0 psi ... 5 psi  | N/C              |          |  |
|   | CP                             | 0 psi ... 10 psi   | N/C              |          |  |
|   | BC                             | 0 psi ... 15 psi   | N/C              |          |  |
|   | CQ                             | 0 psi ... 25 psi   | N/C              |          |  |
|   | DA                             | 0 psi ... 50 psi   | N/C              |          |  |
|   | BF                             | 0 psi ... 100 psi  | N/C              |          |  |
|   | BG                             | 0 psi ... 160 psi  | N/C              |          |  |
|   | BH                             | 0 psi ... 200 psi  | N/C              |          |  |
|   | DG                             | 0 psi ... 250 psi  | N/C              |          |  |
|   | BI                             | 0 psi ... 300 psi  | N/C              |          |  |
|   | BK                             | 0 psi ... 400 psi  | N/C              |          |  |
|   | ??                             | Other - please specify                                       | on inquiry       |          |  |
|   | 4                              | <b>Process connection</b>                                    |                  |          |  |
|   |                                | GD   | G 1/2 B          | N/C      |  |
| ??  |                                | Other - please specify                                       | on inquiry       |          |  |
| 5   | <b>Special design features</b> |  |                  |          |  |
|   | Z                              | Without  | N/C              |          |  |
|   | K                              | FEP cable  | \$86.05          |          |  |
|   | O                              | Lightning protection according to EN 61000-4-5 <sup>1)</sup> | \$99.30          |          |  |
|   | J                              | Temperature measurement Pt 100, 4-wire <sup>1)</sup>         | \$165.50         |          |  |
|   | Y                              | Lightning protection and Pt. 100 <sup>1)</sup>               | \$264.75         |          |  |
|   | 2                              | Hastelloy® C4 <sup>2)</sup>                                  | \$297.85         |          |  |
| ?   | Other - please specify         | on inquiry   |                  |          |  |

1) Only with Pur (polyurethane) cable

2) Only with FEP (Teflon®) cable



# SUBMERSIBLE LIQUID LEVEL

Electronic Pressure > Submersible Liquid Level > LH-10

## LH-10 Smart Codes for Custom Order Configurations (continued)

Field no. Code Feature

|          | Cable length                    | Price            |          |
|----------|---------------------------------|------------------|----------|
|          |                                 | Pur              | FEP      |
|          | Y 5 feet                        | N/C              |          |
|          | 1 10 feet                       | \$16.55          | \$23.20  |
|          | 2 20 feet                       | \$49.65          | \$69.50  |
|          | 3 30 feet                       | \$82.75          | \$115.80 |
|          | 4 40 feet                       | \$115.80         | \$162.15 |
|          | 5 50 feet                       | \$148.95         | \$208.50 |
| <b>6</b> | ? Other - price per foot        | \$3.35           | \$4.60   |
|          | <b>Quality certificates</b>     | Additional price |          |
| <b>7</b> | Z Without                       | N/C              |          |
|          | <b>Digital display</b>          |                  |          |
| <b>8</b> | Z Without                       | N/C              |          |
|          | <b>Additional order details</b> |                  |          |
|          | Z Without                       | N/C              |          |
| <b>9</b> | T Additional order details      | on inquiry       |          |

ELECTRONIC PRESSURE

- 1) FEP (Fluorinated Ethylene Propylene), also known by the Dupont trade name of Teflon®
- 2) Must use G 1/4 B Female process connection

TOTAL PRICE

Order Code:      1            2    3            4            5    6            7    8    9 \*

**LH-10** -  -   -  -   -

\*Additional order details \_\_\_\_\_

# SUBMERSIBLE LIQUID LEVEL

Electronic Pressure > Submersible Liquid Level > IL-10

## Type IL-10 Intrinsically Safe High Performance Submersible Liquid Level Transmitter 50 inWC to 400 psi



ELECTRONIC PRESSURE

### Standard features

- Signal output: 4-20 mA 2-wire
- Supply voltage: 10-30 VDC
- Process connection: G 1/2 B



### IL-10 Smart Codes for Custom Order Configurations

| Field no. | Code | Feature                   | Base price       | \$827.35 |
|-----------|------|---------------------------|------------------|----------|
|           |      |                           | Additional price |          |
| 1         | P    | psi                       | N/C              |          |
|           | N    | InWC                      | N/C              |          |
|           | ?    | Other - please specify    | on inquiry       |          |
|           |      | <b>Pressure range</b>     |                  |          |
|           | GG   | 0 inWC ... 50 inWC        | N/C              |          |
|           | GU   | 0 inWC ... 100 inWC       | N/C              |          |
|           | GV   | 0 inWC ... 150 inWC       | N/C              |          |
|           | GW   | 0 inWC ... 250 inWC       | N/C              |          |
|           | GX   | 0 inWC ... 400 inWC       | N/C              |          |
|           | CN   | 0 psi ... 5 psi           | N/C              |          |
|           | CP   | 0 psi ... 10 psi          | N/C              |          |
|           | BC   | 0 psi ... 15 psi          | N/C              |          |
|           | CQ   | 0 psi ... 25 psi          | N/C              |          |
|           | BD   | 0 psi ... 30 psi          | N/C              |          |
|           | BE   | 0 psi ... 60 psi          | N/C              |          |
|           | BF   | 0 psi ... 100 psi         | N/C              |          |
|           | BG   | 0 psi ... 160 psi         | N/C              |          |
|           | BH   | 0 psi ... 200 psi         | N/C              |          |
|           | BI   | 0 psi ... 300 psi         | N/C              |          |
|           | BK   | 0 psi ... 400 psi         | N/C              |          |
| 2         | ??   | Other - please specify    | on inquiry       |          |
|           |      | <b>Process connection</b> |                  |          |
|           | GD   | G 1/2 B                   | N/C              |          |
| 3         | ??   | Other - please specify    | on inquiry       |          |

# SUBMERSIBLE LIQUID LEVEL

Electronic Pressure > Submersible Liquid Level > IL-10

## IL-10 Smart Codes for Custom Order Configurations (continued)

Field no. Code Feature

|    |   | Additional price  |                        |
|----|---|---|------------------------|
|    |   | <b>Special design features</b>                                  |                        |
|    | Z | Without   | N/C                    |
|    | 2 | Hastelloy® C4 <sup>2)</sup>                                     | \$297.85               |
|    | K | FEP cable <sup>1)</sup>   | \$86.05                |
| 4  | ? | Other - please specify  | on inquiry             |
|    |   | <b>Accuracy</b>   |                        |
|    | G | +/- 0.25% B.F.S.L.  | N/C                    |
| 5  | K | +/- 0.125% B.F.S.L.   | \$66.20                |
|    |   | Cable material  | PUR      FEP           |
|    |   | <b>Cable length</b>   |                        |
|    | Y | 5 feet  | N/C                    |
|    | 1 | 10 feet   | \$16.55      \$23.20   |
|    | 2 | 20 feet   | \$49.65      \$69.50   |
|    | 3 | 30 feet   | \$82.75      \$115.80  |
|    | 4 | 40 feet   | \$115.80      \$162.15 |
|    | 5 | 50 feet   | \$148.95      \$208.50 |
| 6  | ? | Other - price per foot  | \$3.35      \$4.60     |
|    |   | <b>Approvals</b>  |                        |
|    | 2 | EEx IP6X 1D, 1G, M1 per ATEX incl. FM and CSA                   | N/C                    |
|    | U | EEx IP6X 1D, 1G, M1 per ATEX incl. FM, CSA and ship approval GL | \$50.60                |
| 7  | ? | Other - please specify  | on inquiry             |
|    |   | <b>Quality certificates</b>                                     |                        |
|    | Z | Without   | N/C                    |
| 8  | 1 | Other - please specify  | on inquiry             |
|    |   | <b>Digital display</b>  |                        |
| 9  | Z | Without   | N/C                    |
|    |   | <b>Additional order details</b>                                 |                        |
|    | Z | Without   | N/C                    |
| 10 | T | Additional order details  | on inquiry             |

ELECTRONIC PRESSURE

- 1) FEP (Fluorinated Ethylene Propylene), also known by the Dupont trade name of Teflon®
- 2) Must use G 1/4 B Female process connection

Order Code: TOTAL PRICE

1    2
3
4   5   6   7
8   9   \*10

**IL-10 - A -**   **-**  **-**     **-**

\*Additional order details \_\_\_\_\_

# SPECIAL PURPOSE

Electronic Pressure > Special Purpose > MH-2

## Type MH-2 Mobile Hydraulic Pressure Transmitter 1,000 psi to 8,000 psi



Note: 50 piece minimum order quantity applies.

ELECTRONIC PRESSURE

### MH-2 Smart Codes for Custom Order Configurations

| Field no. | Code | Feature                                 | Base price       | \$129.75   |
|-----------|------|---|------------------|------------|
|           |      |   | Additional price |            |
| 1         |      | <b>Signal output</b>                    |                  |            |
|           | A    | 4 ... 20 mA, 2-wire                     |                  | N/C        |
|           | K    | 1 ... 5 V, 3-wire                       |                  | N/C        |
|           | F    | 0 ... 10, 3-wire                        |                  | N/C        |
|           | W    | 0.5-4.5V ratiometric                    |                  | N/C        |
|           | ?    | Other - please specify                  |                  | on inquiry |
| 2         |      | <b>Unit</b>                             |                  |            |
|           | P    | psi                                     |                  | N/C        |
|           | ?    | Other - please specify                  |                  | on inquiry |
| 3         |      | <b>Pressure range</b>                   |                  |            |
|           | BN   | 0 psi ... 1,000 psi                     |                  | N/C        |
|           | BO   | 0 psi ... 1,500 psi                     |                  | N/C        |
|           | BQ   | 0 psi ... 3,000 psi                     |                  | N/C        |
|           | BS   | 0 psi ... 5,000 psi                     |                  | N/C        |
|           | DS   | 0 psi ... 8,000 psi                     |                  | N/C        |
|           | ??   | Other - please specify                  |                  | on inquiry |
| 4         |      | <b>Process connection</b>               |                  |            |
|           | NB   | 1/4" NPT                                |                  | N/C        |
|           | UA   | 7/16-20 UNF SAE #4 J514 male            |                  | N/C        |
|           | GB   | G 1/4 B                                 |                  | N/C        |
|           | HD   | G 1/4 B DIN 3852-E                      |                  | N/C        |
|           | HN   | M 14x1.5 DIN 3852-E                     |                  | N/C        |
|           | ??   | Other - please specify                  |                  | on inquiry |
| 5         |      | <b>Case material</b>                    |                  |            |
|           | M    | Fiberglass reinforced ABS plastic (PBT) |                  | N/C        |
|           | V    | Stainless steel                         |                  | \$10.70    |

# SPECIAL PURPOSE

Electronic Pressure > Special Purpose > MH-2

## MH-2 Smart Codes for Custom Order Configurations (continued)

| Field no. | Code | Feature   | Additional price |
|-----------|------|---|------------------|
|           |      | <b>Electrical connection</b>  |                  |
|           | M4   | 4 Pin locking plug M12 x 1 (NEMA 4/IP67)                                  | N/C              |
|           | R3   | Metri-pack series 150 3-Pin (NEMA 4/IP67)                                 | N/C              |
|           | V4   | 4 Pin bayonet connector (IP69K high pressure steam protection) DIN 72 585 | N/C              |
|           | G3   | Deutsch 3 Pin DT04-3P   | N/C              |
|           | S3   | AMP superseal 1.5 3 Pin (NEMA 4/IP67)                                     | N/C              |
|           | FN   | Cable with free ends (IP 69K high pressure steam protection)              | \$23.80          |
| 6         | ??   | Other - please specify  | on inquiry       |
|           |      | <b>Cable length</b>   |                  |
|           | Z    | Without (always with plug version)  | N/C              |
|           | A    | 0.5 meter (1.6 feet)  | N/C              |
|           | B    | 2 meter (6.5 feet)  | \$6.60           |
|           | G    | 5 meter (16.4 feet)   | \$19.85          |
| 7         | ?    | Other - (2.50 per meter)  | on inquiry       |
|           |      | <b>Quality certificates</b>   |                  |
|           | Z    | Without   | N/C              |
| 8         | 1    | Other - please specify  | on inquiry       |
|           |      | <b>Digital display</b>  |                  |
|           | Z    | Without   | N/C              |
| 9         | 1    | Other display (order separately)  | on inquiry       |
|           |      | <b>Additional order details</b>   |                  |
|           | Z    | Without   | N/C              |
| 10        | T    | Additional order details  | on inquiry       |

ELECTRONIC PRESSURE

**Note: 50 piece minimum order quantity applies.**

TOTAL PRICE

Order Code:

1
2
3
4
5
6
7
8
9
10\*

**MH-2** -  -   -  -  **Z**   -

\*Additional order details \_\_\_\_\_

# SPECIAL PURPOSE

Electronic Pressure > Special Purpose > UT-10, IUT-10

## Type UT-10 UniTrans® Universal Pressure Transmitter

### Standard features

- **Signal output:** 4-20 mA 2-wire
- **Supply voltage:** 12-36 VDC
- **Process connection:** 1/2" NPT male
- **Electrical connection:** M20 x 1.5 cable gland with internal terminal block

### UT-10 Part Numbers

| Gauge Ranges |                |                 |
|--------------|----------------|-----------------|
| Description  |                |                 |
| Range        | Part #         | Price           |
| 0-5 psi      | 4292333        | <b>\$860.40</b> |
| 0-25 psi     | <b>4292341</b> |                 |
| 0-100 psi    | <b>4292350</b> |                 |
| 0-250psi     | <b>4292368</b> |                 |
| 0-500 psi    | <b>4292376</b> |                 |
| 0-1,500 psi  | <b>4292384</b> |                 |
| 0-3,000 psi  | <b>4292392</b> |                 |
| 0-7,500 psi  | <b>4292406</b> |                 |
| 0-15,000 psi | 4292414        |                 |

Ready-to-ship part numbers in **bold print** are available from stock (subject to prior sale). Items without part numbers are available on special order.



ELECTRONIC PRESSURE

## Type IUT-10 Intrinsically Safe UniTrans® Contact factory for pricing information

# SPECIAL PURPOSE

Electronic Pressure > Special Purpose > UT-10

## UT-10 Smart Codes for Custom Order Configurations

| Field no.                       | Code | Feature  | Base price       | \$728.05 |
|---------------------------------|------|--|------------------|----------|
| P                               | psi  | N/C  | Additional price |          |
|                                 | 1    | ? Other - please specify                             | on inquiry       |          |
| <b>Pressure range</b>           |      |  |                  |          |
|                                 | CN   | 0 psi ... 5 psi                                      | N/C              |          |
|                                 | CQ   | 0 psi ... 25 psi                                     | N/C              |          |
|                                 | BF   | 0 psi ... 100 psi                                    | N/C              |          |
|                                 | DG   | 0 psi ... 250 psi                                    | N/C              |          |
|                                 | DI   | 0 psi ... 500 psi                                    | N/C              |          |
|                                 | BO   | 0 psi ... 1,500 psi                                  | N/C              |          |
|                                 | BQ   | 0 psi ... 3,000 psi                                  | N/C              |          |
|                                 | DR   | 0 psi ... 7,500 psi                                  | N/C              |          |
|                                 | BU   | 0 psi ... 15,000 psi                                 | N/C              |          |
| 2                               | ??   | Other - please specify                               | on inquiry       |          |
| <b>Process connection</b>       |      |  |                  |          |
|                                 | GD   | G 1/2 B  | N/C              |          |
|                                 | ND   | 1/2" NPT   | N/C              |          |
| 3                               | ??   | Other - please specify                               | on inquiry       |          |
| <b>Special design features</b>  |      |  |                  |          |
|                                 | Z    | Without  | N/C              |          |
|                                 | G    | Suitable for food                                    | \$59.60          |          |
|                                 | A    | Oxygen, oil and grease free                          | \$99.30          |          |
| 4                               | ?    | Other - please specify                               | on inquiry       |          |
| <b>Case material</b>            |      |  |                  |          |
|                                 | M    | Fiberglass reinforced ABS plastic(PBT)               | N/C              |          |
| 5                               | A    | Aluminum with 3/4" female conduit                    | \$99.30          |          |
| <b>Electrical connection</b>    |      |  |                  |          |
|                                 | A    | Cable gland M20x1.5 with internal terminal block     | N/C              |          |
|                                 | M    | 4 Pin locking plug M12 x 1                           | \$86.05          |          |
|                                 | C    | 3/4" NPT female conduit (only with aluminum case)    | N/C              |          |
| 6                               | ?    | Other - please specify                               | on inquiry       |          |
| <b>Digital display</b>          |      |  |                  |          |
|                                 | A    | With integrated 4 digit LCD-display                  | \$132.40         |          |
|                                 | F    | With integrated 4 digit LCD-display & plastic window | on inquiry       |          |
| 7                               | Z    | Without  | N/C              |          |
| <b>Approvals</b>                |      |  |                  |          |
|                                 | Z    | Without  | N/C              |          |
| 8                               | ?    | Other - please specify                               | on inquiry       |          |
| <b>Quality certificates</b>     |      |  |                  |          |
|                                 | Z    | Without  | N/C              |          |
| 9                               | I    | NIST Certificate of Calibration                      | on inquiry       |          |
| <b>Additional order details</b> |      |  |                  |          |
|                                 | Z    | Without  | N/C              |          |
| 10                              | T    | Additional order details                             | on inquiry       |          |

TOTAL PRICE

Order Code:

1 2 3 4 5 S 6 7 8 9 10\*

**UT-10 - A** -   -  -  **S**    -

\*Additional order details

# SPECIAL PURPOSE

Electronic Pressure > Special Purpose > UT-11, IUT-11

## Type UT-11 UniTrans® Flush Diaphragm Universal Pressure Transmitter

### Standard features

- **Signal output:** 4-20 mA 2-wire
- **Supply voltage:** 12-36 VDC
- **Process connection:** G1B, G1/2B<sup>1</sup>
- **Electrical connection:** M20 x 1.5 cable gland with internal terminal block



ELECTRONIC PRESSURE

### UT-11 Part Numbers

| Gauge Ranges         |         |          |
|----------------------|---------|----------|
| Description          |         |          |
| Range                | Part #  | Price    |
| 0-5 psi <sup>1</sup> | 4292006 | \$919.95 |
| 0-25 psi             | 4292014 |          |
| 0-100 psi            | 4292022 |          |
| 0-250psi             | 4292031 |          |
| 0-500 psi            | 4292040 |          |
| 0-1,500 psi          | 4292058 |          |
| 0-3,000 psi          | 4292066 |          |
| 0-7,500 psi          | 4292074 |          |

NOTE <sup>1</sup>- G1B for 5 psi range, G1/2B for ranges ≥ 25 psi.

## Type IUT-11 Intrinsically Safe UniTrans® Contact factory for pricing information



# SPECIAL PURPOSE

Electronic Pressure > Special Purpose > UT-11

| UT-11 Smart Codes for Custom Order Configurations |      |  |                  |
|---|------|--|------------------|
| Field no.   | Code | Feature  | List price       |
|   |      |  | <b>\$787.60</b>  |
| 1   |      | <b>Unit</b>  |                  |
|   | P    | psi  | N/C              |
|   | 3    | psi absolute   | \$86.05          |
|   | ?    | Other - please specify                               | on inquiry       |
| 2   |      | <b>Pressure range</b>                                | Additional Price |
|   | CN   | 0 psi ... 5 psi                                      | N/C              |
|   | CQ   | 0 psi ... 25 psi (0 psi ... 25 psi absolute)         | N/C              |
|   | BF   | 0 psi ... 100 psi (0 psi ... 100 psi absolute)       | N/C              |
|   | DG   | 0 psi ... 250 psi (0 psi ... 250 psi absolute)       | N/C              |
|   | DI   | 0 psi ... 500 psi                                    | N/C              |
|   | BO   | 0 psi ... 1,500 psi                                  | N/C              |
|   | BQ   | 0 psi ... 3,000 psi                                  | N/C              |
|   | DR   | 0 psi ... 7,500 psi                                  | N/C              |
|   | ??   | Other - please specify                               | on inquiry       |
| 3   |      | <b>Process connection</b>                            |                  |
|   | 85   | G 1 B, flush diaphragm with O-ring (up to 25 psi)    | N/C              |
|   | 86   | G 1/2 B, flush diaphragm with O-ring (> than 25 psi) | N/C              |
|   | ??   | Other - please specify                               | on inquiry       |
| 4   |      | <b>Material of wetted parts</b>                      |                  |
|   | 1    | Stainless steel, NBR O-ring                          | N/C              |
|   | S    | Hastelloy® C4, Viton® O-ring                         | \$258.15         |
|   | ?    | Other - please specify                               | on inquiry       |
| 5   |      | <b>Special design features</b>                       |                  |
|   | G    | Suitable for food                                    | \$59.60          |
|   | Z    | Without  | N/C              |
| 6   |      | <b>Case material</b>                                 |                  |
|   | M    | Fiberglass reinforced ABS plastic(PBT)               | N/C              |
|   | A    | Aluminum with 3/4" NPT female conduit                | \$99.30          |
| 7   |      | <b>Electrical connection</b>                         |                  |
|   | A    | Cable gland M20x1.5 with internal terminal block     | N/C              |
|   | M    | 4 pin locking plug M12 x 1                           | \$86.05          |
|   | C    | 3/4" NPT female conduit (only with aluminum case)    | N/C              |
|   | ?    | Other - please specify                               | on inquiry       |
| 8   |      | <b>Digital display</b>                               |                  |
|   | A    | With integrated 4 digit LCD-display                  | \$132.35         |
|   | F    | With integrated 4 digit LCD-display & plastic window | on inquiry       |
|   | Z    | Without  | N/C              |
| 9   |      | <b>Approvals</b>                                     |                  |
|   | Z    | Without  | N/C              |
|   | ?    | Other - please specify                               | on inquiry       |
| 10  |      | <b>Quality certificates</b>                          |                  |
|   | Z    | Without  | N/C              |
|   | I    | NIST Certificate of Calibration                      | on inquiry       |
| 11  |      | <b>Additional order details</b>                      |                  |
|   | Z    | Without  | N/C              |
|   | T    | Additional order details                             | on inquiry       |

ELECTRONIC PRESSURE

TOTAL PRICE

Order Code:      1      2      3      4 5 6      S      7 8 9      10 11\*

**UT-11 - A -**   -  -    **S**    -

\*Additional order details \_\_\_\_\_

# SPECIAL PURPOSE

Electronic Pressure > Special Purpose > HP-2

## Type HP-2 Industrial Pressure Transmitter



### Standard features

- **Signal output:** 4-20 mA, 0 ... 10 V, etc.
- **Supply voltage:** 10-30 VDC (14-30 VDC for 0-10V)
- **Pressure connection:** M16 x 1.5 female, M20 x 1.5 female  
9/16-18 UNF female F250-C
- **Electrical connection:** DIN 175301-803 L-connector,  
M12 x 1 circular connector,  
flying leads, etc.

ELECTRONIC PRESSURE

### HP-2 Smart Codes for Custom Order Configurations

| Field no. | Code | Feature  | Base price       | \$1,080.00 |
|-----------|------|--|------------------|------------|
|           |      |  | Additional price |            |
|           |      | <b>Type</b>                                    |                  |            |
|           | S    | Standard                                       | N/C              |            |
|           | D    | With DIPS (Diaphragm Impact Protection System) | \$720.05         |            |
| <b>1</b>  | E    | With EPS (Exchange Pressure Connection)        | \$720.05         |            |
|           |      | <b>Non-linearity</b>                           |                  |            |
| <b>2</b>  | G    | 0.25% (B.F.S.L.)                               | N/C              |            |
|           |      | <b>Unit</b>                                    |                  |            |
|           | B    | bar  | \$39.75          |            |
|           | P    | psi  | \$39.75          |            |
| <b>3</b>  | E    | MPa  | \$39.75          |            |
|           |      | <b>Pressure reference</b>                      |                  |            |
| <b>4</b>  | G    | Relative                                       | N/C              |            |
|           |      | <b>Pressure range</b>                          |                  |            |
|           | 616  | 0 ... 1,600 bar                                | N/C              |            |
|           | 625  | 0 ... 2,500 bar                                | N/C              |            |
|           | 640  | 0 ... 4,000 bar                                | \$120.20         |            |
|           | 650  | 0 ... 5,000 bar                                | \$721.20         |            |
|           | 660  | 0 ... 6,000 bar                                | \$1,322.00       |            |
|           | 670  | 0 ... 7,000 bar                                | \$1,923.00       |            |
|           | 680  | 0 ... 8,000 bar                                | \$2,524.00       |            |
| <b>5</b>  | 710  | 0 ... 10,000 bar                               | \$4,929.00       |            |

# SPECIAL PURPOSE

Electronic Pressure > Special Purpose > HP-2

## HP-2 Smart Codes for Custom Order Configurations (continued)

| Field no. | Code                            | Feature                                | Addition   |
|-----------|---------------------------------|--|------------|
| 6         | <b>Process connection</b>       |  |            |
|           | ML                              | M16 x 1.5 female with sealing cone     | N/C        |
|           | MP                              | M20 x 1.5 female with sealing cone     | N/C        |
|           | VZ                              | 9/16 - 18 UNF female F 250-C           | N/C        |
| 7         | <b>Signal output</b>            |  |            |
|           | A                               | 4 ... 20 mA, 2-wire                    | N/C        |
|           | F                               | 0 ... 10 V, 3-wire                     | N/C        |
|           | G                               | 0 ... 5 V, 2-wire                      | N/C        |
| 8         | <b>Electrical connection</b>    |  |            |
|           | A4                              | DIN EN 175301-803 A, IP65              | N/C        |
|           | M4                              | M12 x 1 5 pin circular connection IP67 | N/C        |
|           | DL                              | Cable with free ends IP67              | \$63.55    |
| 9         | <b>Cable length</b>             |  |            |
|           | Z                               | Without (always with plug connection)  | N/C        |
|           | C                               | 1.5 m                                  | N/C        |
|           | ?                               | Other                                  | on inquiry |
| 10        | <b>Quality certificates</b>     |  |            |
|           | Z                               | Without                                | N/C        |
|           | 1                               | Other                                  | on inquiry |
| 11        | <b>Additional order details</b> |  |            |
|           | Z                               | Without                                | N/C        |
|           | T                               | Additional order details               | on inquiry |

ELECTRONIC PRESSURE

Order Code:

TOTAL PRICE

HP-2 - <sup>1</sup> - <sup>2</sup> - <sup>3</sup> <sup>4</sup> <sup>5</sup> - <sup>6</sup> - <sup>7</sup> - <sup>8</sup> <sup>9</sup> - <sup>10</sup> <sup>11\*</sup>

\*Additional order details \_\_\_\_\_

# SPECIAL PURPOSE

Electronic Pressure > Special Purpose > P-30

## Type P-30 Precision Pressure Transmitter



ELECTRONIC PRESSURE

### P-30 Smart Codes for Custom Order Configurations

| Field no. | Code                                 | Feature             | Base price       | \$818.85   |  |
|-----------|--------------------------------------|---------------------|------------------|------------|--|
| 1         | <b>Accuracy</b>                      |                     |                  |            |  |
|           | P                                    | 0.1% of span        | N/C              |            |  |
|           | R                                    | 0.05% of span       | \$488.95         |            |  |
| 2         | <b>Unit</b>                          |                     | Additional Price |            |  |
|           | P                                    | psi                 | N/C              |            |  |
|           | ?                                    | Other               | on inquiry       |            |  |
| 3         | <b>Absolute or relative pressure</b> |                     |                  |            |  |
|           | G                                    | Gauge               | N/C              |            |  |
|           | A                                    | Absolute            | \$76.60          |            |  |
|           | V                                    | Compound            | \$53.05          |            |  |
| 4         | <b>Pressure range</b>                |                     |                  |            |  |
|           | 310                                  | -30 InHg...0        | N/C              |            |  |
|           | 320                                  | -30 InHg...+15 psi  | N/C              |            |  |
|           | 331                                  | -30 InHg...+30 psi  | N/C              |            |  |
|           | 345                                  | -30 InHg...+50 psi  | N/C              |            |  |
|           | 379                                  | -30 InHg...+100 psi | N/C              |            |  |
|           | 412                                  | -30 InHg...+160 psi | N/C              |            |  |
|           | 415                                  | -30 InHg...+200 psi | N/C              |            |  |
|           | 234                                  | 0...5 psig          | 0...5 psia       | N/C        |  |
|           | 269                                  | 0...10 psig         | 0...10 psia      | N/C        |  |
|           | 310                                  | 0...15 psig         | 0...15 psia      | N/C        |  |
|           | 317                                  | 0...25 psig         | 0...25 psia      | N/C        |  |
|           | 321                                  | 0...30 psig         | 0...30 psia      | N/C        |  |
|           | 335                                  | 0...50 psig         | 0...50 psia      | N/C        |  |
|           | 369                                  | 0...100 psig        | 0...100 psia     | N/C        |  |
|           | 411                                  | 0...160 psig        | 0...160 psia     | N/C        |  |
|           | 414                                  | 0...200 psig        | 0...200 psia     | N/C        |  |
|           | 421                                  | 0...300 psig        |                  | N/C        |  |
|           | 434                                  | 0...500 psig        |                  | N/C        |  |
|           | 469                                  | 0...1,000 psig      |                  | N/C        |  |
|           | 510                                  | 0...1,500 psig      |                  | N/C        |  |
|           | 514                                  | 0...2,000 psig      |                  | N/C        |  |
|           | 521                                  | 0...3,000 psig      |                  | N/C        |  |
|           | 534                                  | 0...5,000 psig      |                  | N/C        |  |
|           | 569                                  | 0...10,000 psig     |                  | N/C        |  |
|           | ???                                  | other               |                  | on inquiry |  |

# SPECIAL PURPOSE

Electronic Pressure > Special Purpose > P-30

## P-30 Smart Codes for Custom Order Configurations (continued)

| Field no.                    | Code                            | Feature                                      | Additional price     |
|------------------------------|---------------------------------|--|----------------------|
| 5                            | <b>Pressure connection</b>      |  |                      |
|                              | NB                              | 1/4" NPT                                     | N/C                  |
|                              | ND                              | 1/2" NPT                                     | N/C                  |
|                              | GD                              | G 1/2 B                                      | N/C                  |
|                              | GB                              | G 1/4 B                                      | N/C                  |
|                              | HD                              | G 1/4 A DIN 3852-E                           | N/C                  |
|                              | TB                              | G 1/4 female                                 | N/C                  |
|                              | T4                              | G 1/2 male / G 1/4 female                    | N/C                  |
|                              | ??                              | Other  | on inquiry           |
| 6                            | <b>Sealing</b>                  |  |                      |
|                              | Z                               | Without (not required for NB, ND, TB or T4)) | N/C                  |
|                              | 1                               | NBR (only for HD)                            | N/C                  |
|                              | C                               | Copper (only for GD, GB)                     | N/C                  |
|                              | S                               | Stainless steel (only for GD, GB)            | \$7.55               |
|                              | ?                               | Other  | on inquiry           |
| 7                            | <b>Special design for media</b> |  |                      |
|                              | Z                               | None   | N/C                  |
|                              | ?                               | Other  | on inquiry           |
| 8                            | <b>Signal output</b>            |  |                      |
|                              | A                               | 4 ... 20 mA, 2-wire                          | N/C                  |
|                              | B                               | 0 ... 20 mA, 3-wire                          | N/C                  |
|                              | F                               | 0 ... 10 V, 3-wire                           | N/C                  |
|                              | G                               | 0 ... 5 V, 3-wire                            | N/C                  |
|                              | V                               | 4 ... 20 mA, 3-wire                          | N/C                  |
| 9                            | <b>Electrical connection</b>    |  |                      |
|                              | M                               | 4 circular connector M12x1, 4-pin            | N/C                  |
|                              | B5                              | Plug, M16 x 0.75, 5-pin                      | N/C                  |
|                              | C6                              | Bayonet connector, 6-pin                     | N/C                  |
|                              | A4                              | 4 pin L-plug DIN EN 175301-803, IP65         | N/C                  |
|                              | DL                              | Cable with free ends, IP 67                  | \$76.60              |
| 10                           | <b>Cable length</b>             |  |                      |
|                              | Z                               | Without                                      | N/C                  |
|                              | 6                               | 6 ft (only with DL)                          | N/C                  |
|                              | 7                               | 15 ft (only with DL)                         | \$17.65              |
|                              | ?                               | Other  | on inquiry           |
| <b>Additional order info</b> |                                 |  |                      |
| 11                           | YES                             | NO   | quality certificates |
|                              | 1                               | Z  |                      |
| 12                           | T                               | Z  | additional text      |

Easy Com software with cable: Part #13193075 - \$134.05

Order Code: 1    2    3    4    5    6    7    8    9    10    11    12

**P-30** -  -    -    -  -   -

\*Additional order details \_\_\_\_\_

ELECTRONIC PRESSURE

# SPECIAL PURPOSE

Electronic Pressure > Special Purpose > P-31

## Type P-31 Precision Pressure Transmitter w/Non-clogging Flush Diaphragm



ELECTRONIC PRESSURE

### P-31 Smart Codes for Custom Order Configurations

| Field no.             | Code                                 | Feature       | Base price       | \$866.00 |
|-----------------------|--------------------------------------|---------------|------------------|----------|
| 1                     | <b>Accuracy</b>                      |               |                  |          |
|                       | P                                    | 0.1% of span  | N/C              |          |
|                       | R                                    | 0.05% of span | \$488.85         |          |
| 2                     | <b>Unit</b>                          |               | Additional Price |          |
|                       | P                                    | psi           | N/C              |          |
|                       | ?                                    | Other         | on inquiry       |          |
| 3                     | <b>Absolute or relative pressure</b> |               |                  |          |
|                       | G                                    | Gauge         | N/C              |          |
|                       | A                                    | Absolute      | \$76.60          |          |
|                       | V                                    | Compound      | \$53.05          |          |
| <b>Pressure range</b> |                                      |               |                  |          |
| 310                   | -30 InHg...0                         |               | N/C              |          |
| 320                   | -30 InHg...+15 psi                   |               | N/C              |          |
| 331                   | -30 InHg...+30 psi                   |               | N/C              |          |
| 345                   | -30 InHg...+50 psi                   |               | N/C              |          |
| 379                   | -30 InHg...+100 psi                  |               | N/C              |          |
| 412                   | -30 InHg...+160 psi                  |               | N/C              |          |
| 415                   | -30 InHg...+200 psi                  |               | N/C              |          |
| 234                   | 0...5 psig                           | 0...5 psia    | N/C              |          |
| 269                   | 0...10 psig                          | 0...10 psia   | N/C              |          |
| 310                   | 0...15 psig                          | 0...15 psia   | N/C              |          |
| 317                   | 0...25 psig                          | 0...25 psia   | N/C              |          |
| 321                   | 0...30 psig                          | 0...30 psia   | N/C              |          |
| 335                   | 0...50 psig                          | 0...50 psia   | N/C              |          |
| 369                   | 0...100 psig                         | 0...100 psia  | N/C              |          |
| 411                   | 0...160 psig                         | 0...160 psia  | N/C              |          |
| 414                   | 0...200 psig                         | 0...200 psia  | N/C              |          |
| 421                   | 0...300 psig                         |               | N/C              |          |
| 434                   | 0...500 psig                         |               | N/C              |          |
| 469                   | 0...1,000 psig                       |               | N/C              |          |

# SPECIAL PURPOSE

Electronic Pressure > Special Purpose > P-31

## P-31 Smart Codes for Custom Order Configurations (continued)

| Field no.                       | Code | Feature                                     | Additional price |
|---------------------------------|------|---|------------------|
| <b>Pressure range continued</b> |      |   |                  |
|                                 | 510  | 0...1,500 psig                              | N/C              |
|                                 | 514  | 0...2,000 psig                              | N/C              |
|                                 | 521  | 0...3,000 psig                              | N/C              |
|                                 | 534  | 0...5,000 psig                              | N/C              |
| <b>4</b>                        | ???  | Other                                       | on inquiry       |
| <b>Pressure connection</b>      |      |   |                  |
|                                 | 85   | G1B flush diaphragm w/O-ring (up to 25 psi) | N/C              |
| <b>5</b>                        | 86   | G1/2B flush diaphragm w/O-ring (≥ 30 psi)   | N/C              |
| <b>Sealing</b>                  |      |   |                  |
|                                 | 1    | NBR   | N/C              |
|                                 | B    | EPDM  | N/C              |
|                                 | L    | FPM/FKM                                     | N/C              |
| <b>6</b>                        | ?    | Other                                       | on inquiry       |
| <b>Special design for media</b> |      |   |                  |
|                                 | Z    | None  | N/C              |
| <b>7</b>                        | ?    | Other                                       | on inquiry       |
| <b>Signal output</b>            |      |   |                  |
|                                 | A    | 4 ... 20 mA, 2-wire                         | N/C              |
|                                 | B    | 0 ... 20 mA, 3-wire                         | N/C              |
|                                 | F    | 0 ... 10 V, 3-wire                          | N/C              |
|                                 | G    | 0 ... 5 V, 3-wire                           | N/C              |
| <b>8</b>                        | V    | 4 ... 20 mA, 3-wire                         | N/C              |
| <b>Electrical connection</b>    |      |   |                  |
|                                 | M    | 4 circular connector M12x1, 4 pin           | N/C              |
|                                 | B5   | Plug, M16 x 0.75, 5 pin                     | N/C              |
|                                 | C6   | Bayonet connector, 6 pin                    | N/C              |
|                                 | A4   | 4 pin L-plug DIN EN 175301-803, IP65        | N/C              |
| <b>9</b>                        | DL   | Cable with free ends, IP 67                 | \$76.60          |
| <b>Cable length</b>             |      |   |                  |
|                                 | Z    | Without                                     | N/C              |
|                                 | 6    | 6 ft (only with DL)                         | N/C              |
|                                 | 7    | 15 ft (only with DL)                        | \$17.65          |
| <b>10</b>                       | ?    | Other                                       | on inquiry       |

### Additional order info

|           | YES | NO |                      |
|-----------|-----|----|----------------------|
| <b>11</b> | 1   | Z  | quality certificates |
| <b>12</b> | T   | Z  | additional text      |

**Easy Com software with cable: Part #13193075 - \$134.05**

Order Code: 1      2   3      4      5   6   7      8      9   10      11 12

**P-31**  -  -  -  -  -

\*Additional order details \_\_\_\_\_

ELECTRONIC PRESSURE

# SPECIAL PURPOSE

Electronic Pressure > Special Purpose > R-1

## Type R-1 Refrigeration & AC Transmitter

### Standard features

- All stainless steel construction
- Welded case-to-socket connection



Note: 50 piece minimum order quantity applies.

### R-1 Smart Codes for Custom Order Configurations

| Field no. | Code                  | Feature                | Base price       | \$120.15   |
|-----------|-----------------------|------------------------|------------------|------------|
|           |                       |                        | Additional price |            |
| 1         | <b>Accuracy</b>       |                        |                  |            |
|           | A                     | (</=) 1.0% (B.F.S.L)   | N/C              |            |
| 2         | <b>Unit</b>           |                        |                  |            |
|           | P                     | psi                    | N/C              |            |
|           | B                     | bar                    | N/C              |            |
| 2         | ?                     | Other - please specify | on inquiry       |            |
| 3         | <b>Reference</b>      |                        |                  |            |
|           | G                     | Gauge                  | N/C              |            |
|           | V                     | Compound               | N/C              |            |
| 3         | <b>Pressure range</b> |                        |                  |            |
|           | 379                   | -30 InHg...+100 psi    | N/C              |            |
|           | 415                   | -30 InHg...+200 psi    | N/C              |            |
|           | 422                   | -30 InHg...+300 psi    | N/C              |            |
|           | 442                   | -30 InHg...+600 psi    | N/C              |            |
|           | 369                   | 0...100 psi            | N/C              |            |
|           | 410                   | 0...150 psi            | N/C              |            |
|           | 414                   | 0...200 psi            | N/C              |            |
|           | 421                   | 0...300 psi            | N/C              |            |
|           | 441                   | 0...600 psi            | N/C              |            |
|           | 459                   | 0...850 psi            | N/C              |            |
|           | 411                   | -1...+10 bar           | N/C              |            |
|           | 426                   | -1...+25 bar           | N/C              |            |
|           | 360                   | 0...6 bar              | N/C              |            |
|           | 410                   | 0...10 bar             | N/C              |            |
|           | 416                   | 0...16 bar             | N/C              |            |
|           | 425                   | 0...25 bar             | N/C              |            |
|           | 440                   | 0...40 bar             | N/C              |            |
|           | 460                   | 0...60 bar             | N/C              |            |
|           | 4                     | ?                      | Other            | on inquiry |

ELECTRONIC PRESSURE



# SPECIAL PURPOSE

Electronic Pressure > Special Purpose > R-1

| R-1 Smart Codes for Custom Order Configurations (continued) |                                 |   |                  |  |
|---|---------------------------------|---|------------------|--|
| Field no.   | Code                            | Feature   | Additional price |  |
| 5   | <b>Process connection</b>       |   |                  |  |
|   | NH                              | 1/8" NPT  | N/C              |  |
|   | NB                              | 1/4" NPT  | N/C              |  |
|   | U5                              | 7/16-20UNF-2A 90° Cone  | N/C              |  |
|   | U6                              | 7/16-20UNF-2B Schrader  | N/C              |  |
|   | HA                              | G 1/4 B EN 837  | N/C              |  |
|   | ?                               | Other   | on inquiry       |  |
| 6   | <b>Signal output</b>            |   |                  |  |
|   | W                               | 0.5-4.5V 3-wire ratiometric   | N/C              |  |
|   | A                               | 4-20mA 2-wire   | N/C              |  |
|   | K                               | 1-5V 3-wire   | N/C              |  |
|   | F                               | 0-10V 3-wire  | N/C              |  |
| 7   | <b>Supply voltage</b>           |   |                  |  |
|   | E                               | 5 V DC +/- 10% (only with signal output W)                            | N/C              |  |
|   | G                               | 7...30 V DC (only with signal output A or K)                          | N/C              |  |
|   | C                               | 14...30 V DC (only with signal output F)                              | N/C              |  |
| 8   | <b>Electrical connection</b>    |   |                  |  |
|   | R3                              | Metri pack series 150 3 pin connector (NEMA 4 / IP 67)                | N/C              |  |
|   | M4                              | 4 Pin locking plug M12 x 1 (NEMA 4 / IP 67)                           | N/C              |  |
|   | FN                              | Cable with free ends (NEMA 4 / IP 69K high pressure steam protection) | \$14.15          |  |
| 9   | <b>Cable length</b>             |   |                  |  |
|   | A                               | 0.5 m (1.6 feet)  | N/C              |  |
|   | H                               | 1 m (3.28 feet)   | \$2.35           |  |
|   | B                               | 2 m (6.5 feet)  | \$4.70           |  |
|   | G                               | 5 m (16.4 feet)   | \$9.40           |  |
|   | Z                               | Without (always with electrical connection R3 or M4)                  | N/C              |  |
|   | ?                               | Other   | on inquiry       |  |
| 10  | <b>Approvals</b>                |   |                  |  |
|   | Z                               | Without   | N/C              |  |
|   | W                               | c UL us   | on inquiry       |  |
| 11  | <b>Additional order details</b> |   |                  |  |
|   | Z                               | Without   | N/C              |  |
|   | T                               | Additional order details  | on inquiry       |  |

Note: 50 piece minimum order quantity applies.

TOTAL PRICE: \_\_\_\_\_

Order Code:

1      2   3   4                      5      6   7                      8   9                      10 11

**R-1** -  -  -  -   -

Additional order details \_\_\_\_\_

ELECTRONIC PRESSURE

# SPECIAL PURPOSE

Electronic Pressure > Special Purpose > AC-1

## Type AC-1 Air Conditioning and Refrigeration Pressure Transmitter



AC-1 with M12X1

Note: 50 piece minimum order quantity applies.

ELECTRONIC PRESSURE

### AC-1 Smart Codes for Custom Order Configurations

| Field no. | Code | Feature                                      | Base price       | \$102.50 |
|-----------|------|--|------------------|----------|
|           |      |  | Additional price |          |
| 1         | A    | <b>Accuracy</b><br>( $\leq$ ) 1.0% (B.F.S.L) | N/C              |          |
|           |      | <b>Unit</b>                                  |                  |          |
|           | P    | psi  | N/C              |          |
|           | B    | bar  | N/C              |          |
| 2         | ?    | Other - please specify                       | on inquiry       |          |
|           |      | <b>Reference</b>                             |                  |          |
|           | G    | Gauge  | N/C              |          |
| 3         | V    | Compound                                     | N/C              |          |
|           |      | <b>Pressure range</b>                        |                  |          |
|           | 379  | -30 InHg...+100 psi                          | N/C              |          |
|           | 415  | -30 InHg...+200 psi                          | N/C              |          |
|           | 422  | -30 InHg...+300 psi                          | N/C              |          |
|           | 442  | -30 InHg...+600 psi                          | N/C              |          |
|           | 369  | 0...100 psi                                  | N/C              |          |
|           | 410  | 0...150 psi                                  | N/C              |          |
|           | 414  | 0...200 psi                                  | N/C              |          |
|           | 421  | 0...300 psi                                  | N/C              |          |
|           | 441  | 0...600 psi                                  | N/C              |          |
|           | 459  | 0...850 psi                                  | N/C              |          |
|           | 411  | -1...+10 bar                                 | N/C              |          |
|           | 426  | -1...+25 bar                                 | N/C              |          |
|           | 360  | 0...6 bar                                    | N/C              |          |
|           | 410  | 0...10 bar                                   | N/C              |          |
|           | 416  | 0...16 bar                                   | N/C              |          |
|           | 425  | 0...25 bar                                   | N/C              |          |
|           | 440  | 0...40 bar                                   | N/C              |          |
|           | 460  | 0...60 bar                                   | N/C              |          |
| 4         | ???  | Other  | on inquiry       |          |
|           |      | <b>Process connection</b>                    |                  |          |
|           | NH   | 1/8" NPT                                     | N/C              |          |
|           | NB   | 1/4" NPT                                     | N/C              |          |
|           | U5   | 7/16-20UNF-2A 90° Cone                       | N/C              |          |
|           | U6   | 7/16-20UNF-2B Schrader                       | N/C              |          |
|           | HA   | G 1/4 B EN 837                               | N/C              |          |
| 5         | ??   | Other  | on inquiry       |          |
|           |      | <b>Sensor seal material</b>                  |                  |          |
|           | C    | CR70 (polychlororene)                        | N/C              |          |
| 6         | ?    | Other  | on inquiry       |          |

# SPECIAL PURPOSE

Electronic Pressure > Special Purpose > AC-1

## AC-1 Smart Codes for Custom Order Configurations (continued)

| Field no. | Code | Feature   | Additional price |
|-----------|------|---|------------------|
|           |      | <b>Signal output</b>  |                  |
|           | W    | 0.5-4.5V 3-wire ratiometric   | N/C              |
|           | A    | 4-20mA 2-wire   | N/C              |
|           | F    | 0-10V 3-wire  | N/C              |
| 7         | ?    | Other   | on inquiry       |
|           |      | <b>Supply voltage</b>   |                  |
|           | E    | 5 V DC +/- 10% (only with signal output W)                            | N/C              |
|           | G    | 7...30 V DC (only with signal output A)                               | N/C              |
| 8         | C    | 14...30 V DC (only with signal output F)                              | N/C              |
|           |      | <b>Electrical connection</b>  |                  |
|           | R3   | Metri pack series 150 3 pin connector (NEMA 4 / IP 67)                | N/C              |
|           | M4   | 4 Pin locking plug M12 x 1 (NEMA 4 / IP 67)                           | N/C              |
| 9         | FN   | Cable with free ends (NEMA 4 / IP 69K high pressure steam protection) | \$14.05          |
|           |      | <b>Cable length</b>   |                  |
|           | A    | 0.5 m (1.6 feet)  | N/C              |
|           | H    | 1 m (3.28 feet)   | \$2.35           |
|           | B    | 2 m (6.5 feet)  | \$4.70           |
|           | G    | 5 m (16.4 feet)   | \$9.40           |
|           | Z    | Without (always with electrical connection R3 or M4)                  | N/C              |
| 10        | ?    | Other   | on inquiry       |
|           |      | <b>Approvals</b>  |                  |
|           | Z    | Without   | N/C              |
| 11        | W    | c UL us   | on inquiry       |
|           |      | <b>Additional order details</b>                                       |                  |
|           | Z    | Without   | N/C              |
| 12        | T    | Additional text   | on inquiry       |

ELECTRONIC PRESSURE

**Note: 50 piece minimum order quantity applies.**

TOTAL PRICE: \_\_\_\_\_

Order Code:

1
2
3
4
5
6
7
8
9
10
11
12  
**AC-1** -  -  -  -  -

Additional order details \_\_\_\_\_

## SPECIAL PURPOSE

Electronic Pressure > Special Purpose > TTF-1

# Type TTF-1 Pressure Transmitters with Thin Film Sensor

The Type TTF-1 is designed for engineers who want to provide their own power supply and signal conditioning circuitry. The sensors are manufactured by depositing an insulating layer onto a 17-4PH stainless steel or Elgiloy diaphragm, then depositing a metal strain gauge element by vacuum deposition, resulting in high stability, ruggedness and extended operating life. For improved performance, temperature compensating elements, wiring and balance components are deposited simultaneously during the manufacturing process.



ELECTRONIC PRESSURE

**Contact WIKA for pricing on the TTF-1**  
**Minimum order quantities apply**

# METERS AND DISPLAYS

Electronic Pressure > Meters and Displays > A-AI-1, DI-15

## Type A-AI-1 Attachable Digital Indicator

### Standard features

- Attachable loop powered digital indicator
- Fits Type S-10, S-11 and A-10 transmitters with full size Din plug
- User-programmable 0.4" LCD display



### A-AI-1 Part Numbers

| Ready-To-Ship Meters |                |  |          |
|----------------------|----------------|--|----------|
| Type                 | Part #         | Description  | Price    |
| A-AI-1               | <b>7082534</b> | Loop powered indicator for S-10, S-11 and A-10 using DIN 43 650 electrical connector (4-20 mA 2-wire only) | \$276.90 |

NOTE: Standard items shown in **bold print**. (Subject to prior sale)

ELECTRONIC PRESSURE

## Type DI-15 Digital Meter

### Standard features

- Compact panel mount digital indicator
- Dual solid state relays and RS 485 serial interface
- User-programmable



### DI-15 Part Numbers

| Ready-To-Ship Meters |                |   |          |
|----------------------|----------------|---|----------|
| Type                 | Part #         | Description   | Price    |
| DI15                 | <b>7464880</b> | Digital indicator with 2 solid state relays for panel mounting, accepts 4-20mA, 0-20mA, 01V, 0-10V, Pt1000 signal inputs. | \$276.65 |

NOTE: Standard items shown in **bold print**. (Subject to prior sale)

# 3A SANITARY

Electronic Pressure > 3A Sanitary > S-10-3A

## Type S-10-3A Sanitary Pressure Transmitters

### Standard features

- 3A sanitary pressure transmitter
- Available with an integral cooling extension for high temperature applications (Type S-10-3A.C)



S-10-3A



S-10-3A.C

### S-10-3A Part Numbers

|                                   |                                  |                |
|-----------------------------------|----------------------------------|----------------|
| Pressure Conn.                    | 1½" or 2" Tri-Clamp® connections |                |
| Power Supply                      | 10-30 VDC                        |                |
| Signal output                     | 4-20 mA 2-wire                   |                |
| Elec. Conn.                       | DIN 43 650 with plug connector   |                |
| <b>Vacuum and compound ranges</b> |                                  |                |
| <b>List price</b>                 | <b>\$789.10</b>                  |                |
|                                   | 1.5" Tri-Clamp®                  | 2" Tri-Clamp®  |
| 30"-0 Hg vac                      | <b>9766329</b>                   | <b>9744770</b> |
| 30"-0-30 psi                      | <b>8997395</b>                   | <b>4204042</b> |
| 30"-0-60 psi                      | <b>9799732</b>                   | <b>4224167</b> |
| 30"-0-100 psi                     | <b>4204387</b>                   | <b>4300840</b> |
| <b>Gauge ranges</b>               |                                  |                |
| <b>List price</b>                 | <b>\$707.10</b>                  |                |
| 0-15 psi                          | <b>9748202</b>                   | <b>9748210</b> |
| 0-30 psi                          | <b>9748075</b>                   | <b>4225007</b> |
| 0-50 psi                          | <b>4215789</b>                   | <b>4215771</b> |
| 0-60 psi                          | <b>9744703</b>                   | <b>9748199</b> |
| 0-100 psi                         | <b>9748237</b>                   | <b>9747931</b> |
| 0-160 psi                         | <b>9748245</b>                   | <b>9748253</b> |
| 0-200 psi                         | <b>9749408</b>                   | <b>4213246</b> |
| 0-250 psi                         | <b>9776227</b>                   | <b>4268831</b> |
| 0-300 psi                         | <b>8990985</b>                   | <b>4253877</b> |
| 0-500 psi                         | <b>4205081</b>                   | <b>9745828</b> |
| 0-1,000 psi                       | <b>8993470</b>                   | <b>4281737</b> |

| Electrical connector options |                |                 |
|------------------------------|----------------|-----------------|
| Description                  | Part #         | List price      |
| DIN 43 650 PG-9 plug (std)   | <b>1006711</b> | <b>\$6.10</b>   |
| DIN 43 650 ½" female conduit | <b>1632159</b> | <b>\$6.10</b>   |
| Attachable LCD display       | <b>7082534</b> | <b>\$276.65</b> |
| 5 foot cable IP 67 / NEMA 4  | <b>9744479</b> | <b>\$63.55</b>  |
| 10 foot cable IP 67 / NEMA 4 | <b>9838915</b> | <b>\$69.80</b>  |
| 20 foot cable IP 67 / NEMA 4 | <b>4239904</b> | <b>\$93.85</b>  |
| 30 foot cable IP 67 / NEMA 4 | <b>4239921</b> | <b>\$117.90</b> |
| 50 foot cable IP 67 / NEMA 4 | <b>4293348</b> | <b>\$166.05</b> |
| 4 pin MIL plug PT02E-8-4P    | <b>2184479</b> | <b>\$86.05</b>  |
| 6 pin MIL plug PT02E-10-6P   | <b>9744460</b> | <b>\$86.05</b>  |

| Special order options  |                 |
|--|-----------------|
| Output signals   | List price      |
| 0-20 mA 3-wire   | <b>\$86.05</b>  |
| 0-5 V 3-wire   | <b>\$86.05</b>  |
| 0-10 V 3-wire  | <b>\$86.05</b>  |
| Other  | <b>Inquire</b>  |
| Process connections  | List price      |
| Integral cooling extension for media temp. up to +350°F (177°C) (Type number changes to S-10.3A.C) | <b>\$117.05</b> |
| 3" Tri-Clamp® connection   | <b>Inquire</b>  |
| 4" Tri-Clamp® connection   |                 |
| Cherry Burrell® I-Line   |                 |
| INLINE Seal  |                 |
| Other  |                 |
| Other options  | List price      |
| Electropolished diaphragm to ≤15 Ra  | <b>\$55.05</b>  |
| NEOBEE® M-20 liquid fill   | <b>\$52.35</b>  |
| Food grade silicone liquid fill  | <b>\$52.35</b>  |
| Non-standard pressure range  | <b>Inquire</b>  |
| NIST traceable calibration certificate <0.50% B.F.S.L. (part # 502)                                | <b>\$72.80</b>  |
| Teflon® coated diaphragm   | <b>Inquire</b>  |
| Hastelloy® wetted parts  | <b>Inquire</b>  |

NOTE: Stock items shown in **bold print**.

Items shown with part numbers are available from stock (subject to prior sale). Items without part numbers are available on special order.

# 3A SANITARY

Electronic Pressure > 3A Sanitary > SA-11

## Type SA-11 Sanitary Pressure Transmitters

### Standard features

- Low pressure 3A sanitary pressure transmitter
- Available with 1.5" or 2" Tri-Clamp® connections
- Designed for media temperature to 150°C (300°F)



SA-11



Type SA-11 with IP 68 cable washdown option

ELECTRONIC PRESSURE

### SA-11 Part Numbers

|                     |                                  |                 |
|---------------------|----------------------------------|-----------------|
| Pressure conn.      | 1½" or 2" Tri-Clamp® connections |                 |
| Power supply        | 10-30 VDC                        |                 |
| Signal output       | 4-20 mA 2-wire                   |                 |
| Elec. conn.         | DIN 43 650 with plug connector   |                 |
| <b>Gauge ranges</b> | <b>\$694.95</b>                  |                 |
|                     | 1.5" Tri-Clamp®                  | 2" Tri-Clamp®   |
| 0-100 inWC          | <b>4361853</b>                   | <b>4361861</b>  |
| 0-150 inWC          |                                  | <b>4373576</b>  |
| 0-250 inWC          | <b>4361887</b>                   | <b>4361879</b>  |
| 0-400 inWC          |                                  | <b>50362305</b> |
| 0-25 psi            |                                  | <b>4209986</b>  |
| 0-50 psi            | <b>4200104</b>                   | <b>4200113</b>  |
| 0-100 psi           | <b>4394866</b>                   | <b>50006495</b> |

Other ranges to 400 psi are available

NOTE: Standard items shown in **bold print**. (Subject to prior sale)

Items shown with part numbers are available from stock (subject to prior sale). Items without part numbers are available on special order.



# 3A SANITARY

Electronic Pressure > 3A Sanitary > SA-11

ELECTRONIC PRESSURE

| SA-11 Smart Codes for Custom Order Configurations |                              |  | Base price | \$694.95 |
|---|------------------------------|--|------------|----------|
| Field no.   | Code                         | Feature  |            |          |
| 1   | <b>Signal output</b>         |  |            |          |
|   | A                            | 4 ... 20 mA, 2-wire  | N/C        |          |
|   | B                            | 0 ... 20 mA, 3-wire  | \$86.05    |          |
|   | F                            | 0 ... 10 V, 3-wire   | \$86.05    |          |
|   | G                            | 0 ... 5 V, 3-wire  | \$86.05    |          |
|   | ?                            | Customer specification                                     | \$86.05    |          |
| 2   | <b>Unit</b>                  |  |            |          |
|   | P                            | psi  | N/C        |          |
|   | 3                            | psi absolute   | on inquiry |          |
|   | N                            | InWC   | N/C        |          |
|   | ?                            | Customer specification                                     | on inquiry |          |
| 3   | <b>Pressure range</b>        |  |            |          |
|   | PCA                          | -30/0 inHg   | on inquiry |          |
|   | PCN                          | 0/5 psi  | \$99.30    |          |
|   | PCP                          | 0/10 psi   | on inquiry |          |
|   | PBD                          | 0/30 psi   | on inquiry |          |
|   | PBE                          | 0/60 psi   | on inquiry |          |
|   | PBF                          | 0/100 psi  | N/C        |          |
|   | PBG                          | 0/160 psi  | on inquiry |          |
|   | PBH                          | 0/200 psi  | on inquiry |          |
|   | PBI                          | 0/300 psi  | on inquiry |          |
|   | ???                          | Customer specification                                     | N/C        |          |
|   | NGU                          | 0/100 InWC   | N/C        |          |
|   | NGV                          | 0/150 InWC   | N/C        |          |
|   | NGW                          | 0/250 InWC   | on inquiry |          |
|   | NGX                          | 0/400 InWC   | on inquiry |          |
| 4   | <b>Process connection</b>    |  |            |          |
|   | RT                           | Tri-Clamp® DN 1 1/2"                                       | N/C        |          |
|   | SA                           | Tri-Clamp® DN 2"   | N/C        |          |
|   | ??                           | Customer specification                                     | N/C        |          |
| 5   | <b>Accuracy</b>              |  |            |          |
|   | G                            | +/- 0.25% B.F.S.L.   | N/C        |          |
|   | K                            | +/- 0.125% B.F.S.L.  | \$118.45   |          |
| 6   | <b>Electrical connection</b> |  |            |          |
|   | A4                           | 4 Pin L-plug DIN EN 175301-803 with pg 9 (NEMA 5 // IP 65) | \$6.10     |          |
|   | M4                           | 4 Pin locking plug M12 x 1 (NEMA 4 / IP 67)                | N/C        |          |
|   | EM                           | Vented cable with free ends (NEMA 6 / IP 68)               | on inquiry |          |
|   | ??                           | Customer specification                                     | \$6.10     |          |



# 3A SANITARY

Electronic Pressure > 3A Sanitary > SA-11

## SA-11 Smart Codes for Custom Order Configurations (continued)

| Field no. | Code                            | Feature                | Additional Price |
|-----------|---------------------------------|------------------------|------------------|
| 7         | <b>Cable length</b>             |                        |                  |
|           | Z                               | Without                | N/C              |
|           | Y                               | 5 feet                 | N/C              |
|           | 1                               | 10 feet                | \$12.05          |
|           | 2                               | 20 feet                | \$36.10          |
|           | 3                               | 30 feet                | \$60.15          |
|           | ?                               | Customer specification | \$12.05          |
| 8         | <b>Quality certificates</b>     |                        |                  |
|           | Z                               | Without                | N/C              |
|           | 1                               | Quality certificates   | N/C              |
| 8         | <b>Digital display</b>          |                        |                  |
|           | Z                               | Without                | N/C              |
|           | 1                               | Digital display        | \$251.50         |
| 10        | <b>Additional order details</b> |                        |                  |
|           | Z                               | Without                | N/C              |
|           | T                               | Additional Text        | N/C              |

ELECTRONIC PRESSURE

# 3A SANITARY

Electronic Pressure > 3A Sanitary > F-20-3A

## Type F-20-3A Sanitary Pressure Assembly

ELECTRONIC PRESSURE

### Standard features

- 3A sanitary pressure assembly
- FDA approved system fill
- All-welded design



3/4" connection



Standard 1.5" connection

### F-20-3A Part Numbers

| Pressure conn.                    | 3/4" Tri-Clamp® | 1½" Tri-Clamp®  | 2" Tri-Clamp®   |
|-----------------------------------|-----------------|-----------------|-----------------|
| Power supply                      | 10-30 VDC       |                 |                 |
| Signal output                     | 4 -20 mA 2-wire |                 |                 |
| <b>Ranges</b>                     | <b>\$807.65</b> | <b>\$780.65</b> | <b>\$784.55</b> |
| 0 - 15 psi                        | n/a             | 50236407        | 50236512        |
| 0 - 25 psi                        | n/a             | 50236415        | 50236521        |
| 0 - 30 psi                        | n/a             | 50236423        | 50236539        |
| 0 - 50 psi                        | n/a             | 50236431        | 50236547        |
| 0 - 60 psi                        | 50236334        | 50236440        | 50236555        |
| 0 - 100 psi                       | 50236351        | 50236458        | 50236563        |
| 0 - 160 psi                       | 50236369        | 50236466        | 50236571        |
| 0 - 200 psi                       | 50236377        | 50236474        | 50236580        |
| 0 - 300 psi                       | ---             | ---             | ---             |
| 0 - 500 psi                       | ---             | ---             | ---             |
| 0 - 1,000 psi                     | ---             | ---             | ---             |
| <b>Vacuum and compound ranges</b> | <b>\$854.35</b> | <b>\$866.65</b> | <b>\$870.60</b> |
| -30" Hg Vac                       | n/a             | 50236482        | 50236598        |
| -30" Hg - 30 psi                  | n/a             | 50236491        | 50236601        |
| -30" Hg - 60 psi                  | 50236393        | 50236504        | 50236610        |
| -30" Hg - 100 psi                 | ---             | ---             | ---             |
| -30" Hg - 200 psi                 | ---             | ---             | ---             |

Items shown with part numbers are available from stock (subject to prior sale).  
 Items without part numbers are available on special order.

# 3A SANITARY

Electronic Pressure > 3A Sanitary > F-20-3A

| F-20-3A Smart Codes for Custom Order Configurations |                       |                                     | Base price       | \$780.65   |         |
|---|-----------------------|-------------------------------------|------------------|------------|---------|
| Field no.   | Code                  | Feature                             | Additional price |            |         |
| 1   | <b>Signal output</b>  |                                     |                  |            |         |
|   |                       | 4 ... 20 mA, 2-wire                 |                  | N/C        |         |
|   |                       | 0 ... 10 V, 3-wire (Supply 14-30 V) |                  | \$77.45    |         |
|   |                       | 0 ... 5 V, 3-wire                   |                  | \$77.45    |         |
|   |                       | Other - please specify              |                  | on inquiry |         |
| 2   | <b>Units</b>          |                                     |                  |            |         |
|   |                       | psi                                 |                  | N/C        |         |
|   |                       | InWC                                |                  | N/C        |         |
|   |                       | Other - please specify              |                  | on inquiry |         |
| 3   | <b>Pressure range</b> |                                     |                  |            |         |
|   |                       | -30 inHg ... 0 <sup>1</sup>         |                  | \$86.05    |         |
|   |                       | -30 inHg ... 30 psi <sup>1</sup>    |                  | \$86.05    |         |
|   |                       | -30 inHg ... 60 psi                 |                  | \$86.05    |         |
|   |                       | -30 inHg ... 100 psi                |                  | \$86.05    |         |
|   |                       | -30 inHg ... 160 psi                |                  | \$86.05    |         |
|   |                       | -30 inHg ... 200 psi                |                  | \$86.05    |         |
|   |                       | 0 InWC ... 50 InWC <sup>1,2</sup>   |                  | N/C        |         |
|   |                       | 0 InWC ... 100 InWC <sup>1,2</sup>  |                  | N/C        |         |
|   |                       | 0 psi ... 5 psi <sup>1,2</sup>      |                  | N/C        |         |
|   |                       | 0 psi ... 10 psi <sup>1,2</sup>     |                  | N/C        |         |
|   |                       | 0 psi ... 15 psi <sup>1</sup>       |                  | N/C        |         |
|   |                       | 0 psi ... 30 psi <sup>1</sup>       |                  | N/C        |         |
|   |                       | 0 psi ... 60 psi                    |                  | N/C        |         |
|   |                       | 0 psi ... 100 psi                   |                  | N/C        |         |
|   |                       | 0 psi ... 160 psi                   |                  | N/C        |         |
|   |                       | 0 psi ... 200 psi                   |                  | N/C        |         |
|   |                       | 0 psi ... 300 psi                   |                  | N/C        |         |
|   |                       | 0 psi ... 400 psi                   |                  | N/C        |         |
|   |                       | 0 psi ... 500 psi                   |                  | N/C        |         |
|   |                       | 0 psi ... 600 psi                   |                  | N/C        |         |
|   |                       | 0 psi ... 750 psi                   |                  | N/C        |         |
|   |                       | 0 psi ... 1,000 psi                 |                  | N/C        |         |
|   |                       | 0 psi ... 1,500 psi                 |                  | N/C        |         |
|   |                       | <b>Process connection</b>           |                  |            |         |
|   |                       |                                     | ¾" Tri-Clamp®    |            | \$27.00 |
|   |                       |                                     | 1½" Tri-Clamp®   |            | N/C     |
|   |                       | 2.0" Tri-Clamp®                     |                  | \$3.95     |         |
|   |                       | 2½" Tri-Clamp®                      |                  | \$57.95    |         |
|   |                       | 3.0" Tri-Clamp®                     |                  | \$73.30    |         |
|   |                       | 4.0" Tri-Clamp®                     |                  | \$92.60    |         |
|   |                       | Other - please specify              |                  | on inquiry |         |

ELECTRONIC PRESSURE

# 3A SANITARY

Electronic Pressure > 3A Sanitary > F-20-3A

ELECTRONIC PRESSURE

## F-20-3A Smart Codes for Custom Order Configurations (continued)

| Field no. | Code            | Feature  | Additional Price |
|-----------|-----------------|--|------------------|
| 4         |                 | <b>Material of wetted parts</b>                          |                  |
|           |                 | 316L SS (1.4435) electropolished                         | N/C              |
|           |                 | Hastelloy® C276 (2.4819)                                 | on inquiry       |
|           |                 | PFA coated 316L SS (FDA approved)                        | on inquiry       |
|           |                 | Other - please specify                                   | on inquiry       |
| 5         |                 | <b>System Fill fluid</b>                                 |                  |
|           |                 | KN 7 - Glycerine (note 3 & 4)                            | N/C              |
|           |                 | KN 93 - Food grade silicone oil (note 3)                 | \$48.60          |
|           |                 | KN 59 - NEOBEE® M20                                      | \$48.60          |
|           |                 | KN 92 - Mineral oil (liquid paraffin)                    | N/C              |
|           |                 | Other - please specify                                   | on inquiry       |
| 6         |                 | <b>Electrical connection</b>                             |                  |
|           |                 | ½" NPT female conduit (IP 67)                            | N/C              |
|           |                 | Stainless steel cable gland (IP 68)                      | \$39.75          |
|           |                 | Other - please specify                                   | on inquiry       |
| 7         |                 | <b>Quality certificates</b>                              |                  |
|           |                 | Without  | N/C              |
|           |                 | Certificate - electropolish<br>w/ nominal surface finish | \$64.30          |
|           |                 | Certificate - EN 10 204 3.1B (material traceable)        | \$64.30          |
|           |                 | Certificate of Compliance (C of C)                       | N/C              |
|           |                 | Certificate - NIST calibration                           | \$72.80          |
|           |                 | Other - please specify                                   | on inquiry       |
|           |                 | <b>Additional order details</b>                          |                  |
|           | Without         | N/C  |                  |
|           | Additional text | on inquiry   |                  |

**Notes:**

- (1) Not available with ¾" Tri-Clamp® process connection
- (2) Consult WIKA for suitable process connection size
- (3) Not recommended for vacuum or compound pressure ranges
- (4) Standard offering for ¾" Tri-Clamp® with positive pressure ranges

# MISCELLANEOUS

Electronic Pressure > Miscellaneous > Accessories & Replacement Parts List

## Miscellaneous Parts List

| Part #                       | Description  | Used with model numbers                | List price |
|------------------------------|--|--|------------|
| <b>316 SS Adapters</b>       |  |  |            |
| 1400452                      | G1/2 to 1/2NPT male flush to NPT adapter                     | All with G1/2B flush diaphragm         | \$33.10    |
| 2252651                      | G1/2 to 1/2NPT male flush to NPT adapter .45" bore           | All with G1/2B flush diaphragm         | \$33.10    |
| 2252694                      | G1 to 1/2NPT male flush to NPT adapter .45" bore             | All with G1B flush diaphragm           | \$86.05    |
| 1400460                      | G1/2 to 1/4NPT male flush to NPT adapter                     | All with G1/2B flush diaphragm         | \$33.10    |
| 1206974                      | P-1 G1 weld insert adapter                                   | All with G1B flush diaphragm           | \$59.60    |
| 1097008                      | P-1 G1/2 weld insert adapter                                 | All with G1/2B flush diaphragm         | \$59.60    |
| 1128302                      | 1/2NPT female to 1/4 NPT male adapter                        | All 1/2 NPT male transmitters          | \$33.70    |
| 2250462                      | P-3 Victaulic adapter for G1B                                | All with G1B flush diaphragm           | \$86.05    |
| <b>O-rings and gaskets</b>   |  |  |            |
| 1108247                      | Buna N - G1B O-ring  | All with G1B flush diaphragm           | \$3.35     |
| 1100386                      | Buna N - G1B Gasket  | All with G1B flush diaphragm           | \$3.35     |
| 478164                       | Buna N - G1/2B O-ring  | All with G1/2B flush diaphragm         | \$3.35     |
| 1039067                      | Buna N - G1/2B Gasket  | All with G1/2B flush diaphragm         | \$3.35     |
| 1099094                      | Viton® G1B O-ring  | All with G1B flush diaphragm           | \$7.25     |
| 1145967                      | Viton® G1B Gasket  | All with G1B flush diaphragm           | \$7.25     |
| 1158295                      | Viton® G1/2B O-ring  | All with G1/2B flush diaphragm         | \$7.25     |
| 1039075                      | Viton® G1/2B Gasket  | All with G1/2B flush diaphragm         | \$7.25     |
| <b>Electrical connectors</b> |  |  |            |
| 1006711                      | DIN 43650 standard replacement connector PG                  | All S and IS series                    | \$6.10     |
| 1632159                      | DIN 43650 1/2" female conduit connector                      | S-1X, IS-2X                            | \$6.10     |
| 9735882                      | Mini DIN standard replacement connector                      | C-10, others with MiniDIN connection   | \$6.60     |
| 9740010                      | Mini DIN with molded 6 foot (2 meter) cable                  | C-10, others with MiniDIN connection   | \$35.15    |
| 2055816                      | 6 foot (2 m) cable with 5 pin M12x1 female plug              | All with M12x1 5 pin male connections  | \$23.80    |
| 11250798                     | 6 foot (2m) cable with 4 pin angled M12X1 female plug        | All with M12x1 4 pin connector         | \$26.80    |
| 11250780                     | 6 foot (2m) cable with 4 pin straight M12X1 female plug      | All with M12x1 4 pin connector         | \$26.80    |
| 11250232                     | 15 foot (4.5m) cable with 4 pin angled M12X1 female plug     | All with M12x1 4 pin connector         | \$43.95    |
| 11250259                     | 15 foot (4.5m) cable with 4 pin angled M12X1 female plug     | All with M12x1 4 pin connector         | \$43.95    |
| 11225793                     | 6 foot (2m) cable with form A (Full Size DIN) female plug    | A-10, S-1X, IS-2X with male connection | \$37.50    |
| 11250186                     | 15 foot (4.5m) cable with form A (Full Size DIN) female plug | A-10, S-1X, IS-2X with male connection | \$54.65    |
| 11225823                     | 6 foot (2m) cable with form C (miniDIN) female plug          | A-10 only                              | \$37.50    |
| 11250194                     | 15 foot (4.5m) cable with form C (miniDIN) female plug       | A-10 only                              | \$54.65    |
| 9734821                      | DIN 43650 with molded 6 foot (2 meter) cable                 | S-1X, IS-2X                            | \$46.35    |

# MISCELLANEOUS

Electronic Pressure > Miscellaneous > Accessories & Replacement Parts List

ELECTRONIC PRESSURE

| Part #                              | Description                                | Used with model numbers       | List price |
|-------------------------------------|--|-------------------------------|------------|
| Submersible transmitter accessories |  |                               |            |
| 9836700                             | Vent tube desiccant drying cartridge       | LS-10, LH-10, IL-10           | \$18.55    |
| 50600770                            | VentGuard® cable protection kit            | LS-10, LH-10, IL-10           | \$140.20   |
| 7193131                             | Vent tube filter                           | LS-10, LH-10, IL-10           | \$13.25    |
| 2074257                             | Cable clamp                                | LS-10, LH-10, IL-10           | \$27.80    |
| 2459686                             | Cable junction box                         | LS-10, LH-10, IL-10           | \$99.30    |
| 1524399                             | Additional weight                          | LS-10, LH-10, IL-10           | \$86.05    |
| 50077091                            | LevelGuard attachment *                    | LS-10, LH-10, IL-10           | \$522.85   |
| 50476114                            | 1/2NPT cable conduit adapter *             | LS-10, LH-10                  | \$33.10    |
| 1631322                             | G1/2 - Male 1/2NPT - 1/4NPT female adaptor | LS-10, LH-10, IL-10           | \$33.10    |
| Other miscellaneous accessories     |  |                               |            |
| 11449978                            | Restrictor screw installed *               | for 1/2" or 1/4"NPT, SAE male | \$6.60     |
| 502                                 | NIST Certificate 0.25% *                   | S-10, S-11, others            | \$72.80    |
| 9795885                             | 4-20 mA to 1-5V output signal conversion * | S-10, S-11                    | \$39.75    |
| 504                                 | NIST Certificate 0.125% *                  | S-10, S-11                    | \$105.90   |
| 4200767                             | NIST Certificate 0.10% *                   | P-30, P-31                    | \$165.50   |
| 2396756                             | NIST Certificate 0.20% UniTrans® *         | UniTrans® only                | \$113.45   |

\* Factory installed items cannot be user installed

# ASSEMBLED SEALS

Diaphragm Seals > Assembled Seals > M93X.25

| M93X.25 Smart Code Configuration             |   |               |
|--|---|---------------|
| Field no.                                    | Code  | List price    |
| <b>Case filling for vibration protection</b> |   |               |
| 1  | 2 Without <sup>1</sup>  | \$495.10      |
|  | 3 Glycerine (standard)  | \$524.80      |
| <b>Unit</b>                                  |   |               |
| 2  | P psi   | N/C           |
|  | S Special pressure range  | on inquiry    |
| <b>Pressure range</b>                        |   |               |
| 3  | V331 -30 inHg...30 psi  | \$4.40        |
|  | V352 -30 inHg...60 psi  | \$4.40        |
|  | V379 -30 inHg...100 psi   | \$4.40        |
|  | V412 -30 inHg...160 psi   | \$4.40        |
|  | V415 -30 inHg...200 psi   | \$4.40        |
|  | G321 0 psi...30 psi   | N/C           |
|  | G341 0 psi...60 psi   | N/C           |
|  | G369 0 psi...100 psi  | N/C           |
|  | G411 0 psi...160 psi  | N/C           |
|  | G414 0 psi...200 psi  | N/C           |
|  | G421 0 psi...300 psi  | N/C           |
|  | G428 0 psi...400 psi  | N/C           |
|  | G441 0 psi...600 psi  | N/C           |
| <b>2nd Scale / special scale</b>             |   |               |
| 4  | K 2nd Scale kg/cm <sup>2</sup>  | N/C           |
|  | B 2nd Scale bar   | N/C           |
|  | L 2nd Scale kPa   | N/C           |
|  | Z Without   | on inquiry    |
| <b>Window</b>                                |   |               |
| 5  | E Polycarbonate   | N/C           |
|  | 8 Polysulfone <sup>1</sup>  | \$15.15       |
| <b>Material of wetted parts</b>              |   |               |
| 6  | CT 316L SS (1.4435) electropolished                                     | N/C           |
|  | H2 Hastelloy® C276 (2.4819)   | \$681.95      |
|  | ?? Other - please specify   | on inquiry    |
| <b>Fill fluid</b>                            |   |               |
| 7  | F1 KN 7 Glycerine <sup>2</sup>  | N/C           |
|  | K3 KN 93 - Food grade silicone  | \$43.55       |
|  | K5 KN 59 - NEOBEE® M20  | \$43.55       |
|  | J2 KN 92 - Medicinal white mineral oil                                  | \$14.20       |
|  | ?? Other - please specify   | on inquiry    |
| <b>Gasket</b>                                |   |               |
| 8  | H EPDM  | N/C           |
|  | ? Other - please specify  | on inquiry    |
| <b>Quality certificates</b>                  |   |               |
| 9  | Z Without   | N/C           |
|  | 2 Certificate 2.2 EN 10204  | ref. page 262 |
|  | 3 Certificate 3.1 EN 10204  | ref. page 262 |
| <b>Additional order details</b>              |   |               |
| 10   | Z Without   | N/C           |
|  | O External "zero" adjust  | \$52.45       |
|  | K Autoclave design, case with weep holes <sup>1</sup>                   | \$17.25       |
|  | M Integral cooling element for clean steam option up to 149 °C (300 °F) | \$228.15      |
|  | T Additional order details  | on inquiry    |



DIAPHRAGM SEALS

<sup>1</sup> Dry case and polysulfone window are required for special autoclave design

<sup>2</sup> Not recommended for vacuum or compound ranges

Order Code:    1            2            3            4            5            6            7            8            9    10\*

**M93**  **.25** -     -  -     -

\*Additional order details \_\_\_\_\_  
(see Page 229)

# ASSEMBLED SEALS

Diaphragm Seals > Assembled Seals > M93X.3A

DIAPHRAGM SEALS

| M93X.3A Smart Code Configuration |  |                                  |                   |
|----------------------------------|--|----------------------------------|-------------------|
| Field no.                        | Code   | List price                       |                   |
| 1                                | <b>Case filling for vibration protection</b> |                                  | 2½" 4"            |
|                                  | 2  | Without <sup>1</sup>             | N/C               |
|                                  | 3  | Glycerine (standard)             | \$4.50 \$16.35    |
| 2                                | <b>Nominal size</b>                          |                                  | <b>Add. price</b> |
|                                  | C  | 2½"                              | \$481.10          |
|                                  | E  | 4"                               | \$532.20          |
| 3                                | <b>Unit</b>                                  |                                  |                   |
|                                  | P  | psi                              | N/C               |
|                                  | S  | Special pressure range           | on inquiry        |
| 4                                | <b>Pressure range</b>                        |                                  |                   |
|                                  | V310   | -30 inHg...0                     | \$4.40            |
|                                  | V321   | -30 inHg...15 psi                | \$4.40            |
|                                  | V331   | -30 inHg...30 psi                | \$4.40            |
|                                  | V352   | -30 inHg...60 psi                | \$4.40            |
|                                  | V379   | -30 inHg...100 psi               | \$4.40            |
|                                  | V412   | -30 inHg...160 psi               | \$4.40            |
|                                  | V415   | -30 inHg...200 psi               | \$4.40            |
|                                  | G310   | 0 psi...15 psi                   | N/C               |
|                                  | G321   | 0 psi...30 psi                   | N/C               |
|                                  | G341   | 0 psi...60 psi                   | N/C               |
|                                  | G369   | 0 psi...100 psi                  | N/C               |
|                                  | G411   | 0 psi...160 psi                  | N/C               |
|                                  | G414   | 0 psi...200 psi                  | N/C               |
|                                  | G421   | 0 psi...300 psi                  | N/C               |
|                                  | G428   | 0 psi...400 psi                  | N/C               |
|                                  | G441   | 0 psi...600 psi                  | N/C               |
|                                  | G455   | 0 psi...800 psi                  | N/C               |
|                                  | 5  | <b>2nd Scale / special scale</b> |                   |
| K                                |  | 2nd Scale kg/cm <sup>2</sup>     | N/C               |
| B                                |  | 2nd Scale bar                    | N/C               |
| L                                |  | 2nd Scale kPa                    | N/C               |
| 6                                | Z  | Without                          | N/C               |
|                                  | <b>Connector position</b>                    |                                  | 2½" 4"            |
|                                  | U  | Lower mount                      | N/C               |
|                                  | 3  | Lower back mount                 | N/A \$76.45       |
| 7                                | B  | Center back mount                | \$4.75 N/A        |
|                                  | ?  | Other - please specify           | on inquiry        |
|                                  | <b>Window</b>                                |                                  | 2½" 4"            |
| 8                                | E  | Polycarbonate                    | N/C               |
|                                  | 8  | Polysulfone <sup>1</sup>         | \$26.45 \$49.00   |
| 8                                | <b>Process connection</b>                    |                                  | <b>Add. price</b> |
|                                  | TB115  | 1½" Tri-clamp®                   | N/C               |
|                                  | TB120  | 2" Tri-clamp®                    | \$7.75            |
|                                  | TB125  | 2½" Tri-clamp®                   | \$100.60          |
|                                  | TB130  | 3" Tri-clamp®                    | \$126.10          |
|                                  | TB140  | 4" Tri-clamp®                    | \$160.15          |
| 8                                | ????   | Other - please specify           | on inquiry        |

| M93X.3A Smart Code Configuration |                                 |   |                     |
|----------------------------------|---------------------------------|---|---------------------|
| Field no.                        | Code                            | List price  |                     |
| 9                                | <b>Wetted parts material</b>    |   |                     |
|                                  | CT                              | 316L SS (1.4435) electropolished                    | N/C                 |
|                                  | H2                              | Hastelloy® C276 (2.4819)                            | \$1,160.85          |
|                                  | ??                              | Other - please specify                              | on inquiry          |
| 10                               | <b>Fill Fluid</b>               |   |                     |
|                                  | F1                              | KN 7 Glycerine <sup>2</sup>                         | N/C                 |
|                                  | K3                              | KN 93 - Food grade silicone                         | \$43.55             |
|                                  | K5                              | KN 59 - NEOBEE® M20                                 | \$43.55             |
|                                  | J2                              | KN 92 - Medicinal white mineral oil                 | \$14.20             |
|                                  | ??                              | Other - please specify                              | on inquiry          |
| 11                               | <b>Gasket</b>                   |   |                     |
|                                  | Z                               | Without   | N/C                 |
| 12                               | <b>Quality certificates</b>     |   |                     |
|                                  | Z                               | Without   | N/C                 |
|                                  | 2                               | Certification 2.2 EN 10204                          | ref. pages 261, 262 |
|                                  | 3                               | Certification 3.1 EN 10204                          | ref. pages 261, 262 |
| 13                               | <b>Additional order details</b> |   |                     |
|                                  | Z                               | Without   | N/C                 |
|                                  | K                               | Autoclave design, case with weep holes <sup>1</sup> | \$16.85             |
|                                  | T                               | Additional order details                            | on inquiry          |

<sup>1</sup> Dry case and polysulfone window are required for special autoclave design

<sup>2</sup> Not recommended for vacuum or compound ranges



Order Code:

1 2 3 4 5 6 7 8 9 10 11 12 13\*

**M93**  **.3A** -  -    -   -       -

\*Additional order details \_\_\_\_\_  
(see Page 229)



# ASSEMBLED SEALS

Diaphragm Seals > Assembled Seals > M932.2C

| M932.2C Smart Code Configuration |                                  |                                   |                     |
|----------------------------------|----------------------------------|-----------------------------------|---------------------|
| Field no.                        | Code                             |                                   | List price          |
| <b>Nominal size</b>              |                                  |                                   |                     |
| 1                                | A                                | 1½"                               | \$500.90            |
|                                  | B                                | 2"                                | \$479.70            |
| <b>Unit</b>                      |                                  |                                   |                     |
| 2                                | P                                | psi                               | N/C                 |
|                                  | S                                | Special pressure range            | on inquiry          |
| <b>Pressure range</b>            |                                  |                                   |                     |
| 3                                | V331                             | -30 inHg...30 psi                 | \$8.50              |
|                                  | V352                             | -30 inHg...60 psi                 | \$8.50              |
|                                  | V379                             | -30 inHg...100 psi                | \$8.50              |
|                                  | V412                             | -30 inHg...160 psi                | \$8.50              |
|                                  | V415                             | -30 inHg...200 psi                | \$8.50              |
|                                  | G321                             | 0 psi...30 psi                    | N/C                 |
|                                  | G341                             | 0 psi...60 psi                    | N/C                 |
|                                  | G369                             | 0 psi...100 psi                   | N/C                 |
|                                  | G411                             | 0 psi...160 psi                   | N/C                 |
|                                  | G414                             | 0 psi...200 psi                   | N/C                 |
|                                  | G421                             | 0 psi...300 psi                   | N/C                 |
|                                  | G428                             | 0 psi...400 psi                   | N/C                 |
|                                  | G441                             | 0 psi...600 psi                   | N/C                 |
|                                  | <b>2nd Scale / special scale</b> |                                   |                     |
| 4                                | K                                | 2nd Scale kg/cm <sup>2</sup>      | N/C                 |
|                                  | B                                | 2nd Scale bar                     | N/C                 |
|                                  | L                                | 2nd Scale kPa                     | N/C                 |
|                                  | Z                                | Without                           | N/C                 |
| <b>Connector position</b>        |                                  |                                   |                     |
| 5                                | U                                | Lower mount                       | N/C                 |
|                                  | B                                | Center back mount                 | N/C                 |
| <b>Process connection</b>        |                                  |                                   |                     |
| 6                                | TB107                            | ¾" Tri-clamp®                     | N/C                 |
|                                  | ????                             | Other - please specify            | on inquiry          |
| <b>Material of wetted parts</b>  |                                  |                                   |                     |
| 7                                | C2                               | 316L SS (1.4435)                  | N/C                 |
|                                  | CT                               | 316L SS (1.4435) electropolished  | \$44.00             |
|                                  | H2                               | Hastelloy® C276 (2.4819)          | \$716.05            |
|                                  | ??                               | Other - please specify            | on inquiry          |
| <b>Nominal size</b>              |                                  |                                   |                     |
| 8                                | F1                               | KN 7 Glycerine <sup>1</sup>       | N/C                 |
|                                  | K3                               | KN 93 - Food grade silicone       | \$43.55             |
|                                  | K5                               | KN 59 - NEOBEE® M20               | \$43.55             |
|                                  | J2                               | KN 92 Medicinal white mineral oil | \$14.20             |
|                                  | ??                               | Other - please specify            | on inquiry          |
| <b>Quality certificates</b>      |                                  |                                   |                     |
| 9                                | Z                                | Without                           | N/C                 |
|                                  | 2                                | Certificate 2.2 EN 10204          | ref. pages 261, 262 |
|                                  | 3                                | Certificate 3.1 EN 10204          | ref. pages 261, 262 |
| <b>Additional order details</b>  |                                  |                                   |                     |
| 10                               | Z                                | Without                           | N/C                 |
|                                  | T                                | Additional order details          | on inquiry          |



DIAPHRAGM SEALS

<sup>1</sup> Not recommended for vacuum or compound ranges

Order Code:      1      2      3      4      5      6      7      8      9      10\*

**M932.2C** -  -     -  -     -

\*Additional order details \_\_\_\_\_  
(see Page 229)

# ASSEMBLED SEALS

Diaphragm Seals > Assembled Seals > M93X.D1

DIAPHRAGM SEALS

| M93X.D1 Smart Code Configuration |  |                              |                        |
|----------------------------------|--|------------------------------|------------------------|
| Field no.                        | Code   | List price                   |                        |
| 1                                | <b>Case filling for vibration protection</b> |                              |                        |
|                                  | 2  | Without                      | N/C                    |
|                                  | 3  | Glycerine (standard)         | \$28.45                |
|                                  | P  | Silicone (1,000 cSt)         | \$52.20                |
|                                  | ?  | Other - please specify       | on inquiry             |
| 2                                | <b>Nominal gauge size</b>                    |                              |                        |
|                                  | U  | 4½"                          | \$343.60               |
| 3                                | <b>Unit</b>                                  |                              |                        |
|                                  | P  | psi                          | N/C                    |
|                                  | S  | Special pressure range       | on inquiry             |
|                                  | <b>Range</b>                                 |                              |                        |
|                                  | V310   | -30 inHg...0                 | N/C                    |
| V321                             | -30 inHg...15 psi                            | N/C                          |                        |
| V331                             | -30 inHg...30 psi                            | N/C                          |                        |
| V352                             | -30 inHg...60 psi                            | N/C                          |                        |
| V379                             | -30 inHg...100 psi                           | N/C                          |                        |
| V412                             | -30 inHg...160 psi                           | N/C                          |                        |
| V415                             | -30 inHg...200 psi                           | N/C                          |                        |
| 4                                | G310   | 0 psi...15 psi               | N/C                    |
|                                  | G321   | 0 psi...30 psi               | N/C                    |
|                                  | G341   | 0 psi...60 psi               | N/C                    |
|                                  | G369   | 0 psi...100 psi              | N/C                    |
|                                  | G411   | 0 psi...160 psi              | N/C                    |
|                                  | G414   | 0 psi...200 psi              | N/C                    |
|                                  | G421   | 0 psi...300 psi              | N/C                    |
|                                  | G428   | 0 psi...400 psi              | N/C                    |
|                                  | G441   | 0 psi...600 psi              | N/C                    |
|                                  | G469   | 0 psi...1,000 psi            | N/C                    |
|                                  | G510   | 0 psi...1,500 psi            | N/C                    |
|                                  | G514   | 0 psi...2,000 psi            | N/C                    |
|                                  | G521   | 0 psi...3,000 psi            | N/C                    |
|                                  | G534   | 0 psi...5,000 psi            | N/C                    |
|                                  | 4  | ????                         | Other - please specify |
| 5                                | <b>2nd Scale / special scale</b>             |                              |                        |
|                                  | K  | 2nd Scale kg/cm <sup>2</sup> | N/C                    |
|                                  | B  | 2nd Scale bar                | N/C                    |
|                                  | L  | 2nd Scale kPa                | N/C                    |
| 6                                | <b>Connector Position</b>                    |                              |                        |
|                                  | U  | Lower mount                  | N/C                    |
| 6                                | 3  | Lower back mount             | N/C \$15.35            |
|                                  | ?  | Other - please specify       | on inquiry             |
|                                  | <b>Window</b>                                |                              |                        |
| 7                                | A  | Acrylic                      | N/C                    |
|                                  | G  | Flat instrument glass        | \$15.35                |
|                                  | H  | Laminated safety glass       | \$24.35                |

| M93X.D1 Smart Code Configuration |                                 |   |                     |
|----------------------------------|---------------------------------|---|---------------------|
| Field no.                        | Code                            | List price                                    |                     |
| 8                                | <b>Process connection</b>       |   |                     |
|                                  | P4M                             | ¼" NPT male                                   | N/C                 |
|                                  | P2M                             | ½" NPT male                                   | N/C                 |
|                                  | P4F                             | ¼" NPT female                                 | N/C                 |
|                                  | P2F                             | ½" NPT female                                 | N/C                 |
| 8                                | ???                             | Other - please specify                        | on inquiry          |
| 9                                | <b>Diaphragm material</b>       |   |                     |
|                                  | C2                              | 316L SS (1.4435)                              | N/C                 |
|                                  | H2                              | Hastelloy® C276 (2.4819)                      | \$60.60             |
|                                  | M1                              | Monel® 400 (2.4360)                           | \$24.35             |
|                                  | D1                              | Duplex 2205 (1.4462)                          | on inquiry          |
| 9                                | ??                              | Other - please specify                        | on inquiry          |
| 10                               | <b>Lower housing material</b>   |   |                     |
|                                  | C2                              | 316L SS (1.4435)                              | N/C                 |
|                                  | H2                              | Hastelloy® C276 (2.4819)                      | \$799.00 \$1,489.00 |
|                                  | M1                              | Monel® 400 (2.4360)                           | on inquiry          |
|                                  | D1                              | Duplex 2205 (1.4462)                          | on inquiry          |
| 10                               | ??                              | Other - please specify                        | on inquiry          |
| 11                               | <b>Fill fluid</b>               |   |                     |
|                                  | B2                              | KN 68 - DC 200 (10 cSt)                       | N/C                 |
|                                  | A1                              | KN 2 - DC 200 (50 cSt)                        | N/C                 |
|                                  | A2                              | KN 32 - High temperature silicone oil         | \$24.35             |
|                                  | E1                              | KN 21 - Halocarbon® 6.3                       | \$24.35             |
| 11                               | ??                              | Other - please specify                        | on inquiry          |
| 12                               | <b>Flushing connection</b>      |   |                     |
|                                  | 1                               | Without                                       | N/C                 |
|                                  | 2                               | 1 x ¼" NPT                                    | \$42.55             |
|                                  | 5                               | 2 x ¼" NPT                                    | \$84.95             |
|                                  | ?                               | Other - please specify                        | on inquiry          |
| 13                               | <b>Special design features</b>  |   |                     |
|                                  | Z                               | Without                                       | N/C                 |
|                                  | A                               | Clean for O <sub>2</sub> service <sup>1</sup> | \$60.60             |
| 13                               | ?                               | Other - please specify                        | on inquiry          |
| 14                               | <b>Quality certificates</b>     |   |                     |
|                                  | Z                               | Without                                       | N/C                 |
|                                  | 2                               | Certificate 2.2 EN 10204                      | ref. pages 261, 262 |
| 14                               | 3                               | Certificate 3.1 EN 10204                      | ref. pages 261, 262 |
| 15                               | <b>Additional order details</b> |   |                     |
|                                  | Z                               | Without                                       | N/C                 |
|                                  | 2                               | Stainless steel tag                           | \$9.70              |
|                                  | T                               | Additional order details                      | on inquiry          |

<sup>1</sup> Per ASME B40.100 Level IV

Order Code:

1      2      3      4      5      6      7      8      9      10      11      12      13      14      15\*

**M93**  **.D1** -  -    -   -       -

\*Additional order details (see Page 229) \_\_\_\_\_

# ASSEMBLED SEALS

Diaphragm Seals > Threaded Seals > 990.TA



990.TA (see chart on right)



| 990.TA Smart Code Configuration |      |                          |                        |            |
|---------------------------------|------|--------------------------|------------------------|------------|
| Field no.                       | Code | List price               |                        |            |
| <b>Process connection</b>       |      |                          |                        |            |
| 1                               | P4F  | 1/4" NPT female          | N/C                    |            |
|                                 | P2F  | 1/2" NPT female          | N/C                    |            |
|                                 | P4M  | 1/4" NPT male            | \$33.55                |            |
|                                 | P2M  | 1/2" NPT male            | \$33.55                |            |
|                                 | ???  | Other - please specify   | on inquiry             |            |
| <b>Nominal pressure rating</b>  |      |                          |                        |            |
| 2                               | P3   | 2500 psi MWP             | N/C                    |            |
|                                 | ??   | Other - please specify   | on inquiry             |            |
| <b>Upper housing material</b>   |      |                          |                        |            |
| 3                               | C2   | 316L SS (1.4435)         | \$97.45                |            |
|                                 | M1   | Monel® 400 (2.4360)      | on inquiry             |            |
|                                 | ??   | Other - please specify   | on inquiry             |            |
| <b>Diaphragm material</b>       |      |                          |                        |            |
| 4                               | C2   | 316L SS (1.4435)         | N/C                    |            |
|                                 | H2   | Hastelloy® C276 (2.4819) | \$11.10                |            |
|                                 | M1   | Monel® 400 (2.4360)      | \$12.80                |            |
|                                 | C0   | Carpenter 20             | \$11.15                |            |
|                                 | ??   | Other - please specify   | on inquiry             |            |
| <b>Lower housing material</b>   |      | <b>Female</b>            | <b>Male</b>            |            |
| 5                               | C2   | 316L SS (1.4435)         | N/C                    |            |
|                                 | H2   | Hastelloy® C276 (2.4819) | \$278.65               | \$380.35   |
|                                 | M1   | Monel® 400 (2.4360)      | on inquiry             | on inquiry |
|                                 | C0   | Carpenter 20             | on inquiry             | on inquiry |
|                                 | ??   | Other - please specify   | on inquiry             | on inquiry |
| <b>Flushing connection</b>      |      | <b>C2</b>                | <b>Other materials</b> |            |
| 6                               | Z    | Without                  | N/C                    |            |
|                                 | 1    | 1 x 1/8" NPT female      | \$44.50                | on inquiry |
|                                 | 2    | 1 x 1/4" NPT female      | \$44.50                | on inquiry |
|                                 | ?    | Other - please specify   | N/C                    | N/C        |



M93X.D1 (see chart on page 200)

Order Code:      1            2            3            4            5            6

**990.TA-**       **ZZZ**

\*Additional order details \_\_\_\_\_  
(see Page 229)

DIAPHRAGM SEALS

# THREADED SEALS

Diaphragm Seals > Threaded Seals > 990.TB



## 990.TB Smart Code Configuration

| Field no.                      | Code | List price               |                        |
|--------------------------------|------|--------------------------|------------------------|
| <b>Process connection</b>      |      |                          |                        |
|                                | P4F  | 1/4" NPT female          | N/C                    |
|                                | P2F  | 1/2" NPT female          | N/C                    |
|                                | P3F  | 3/4" NPT female          | N/C                    |
|                                | P1F  | 1" NPT female            | N/C                    |
|                                | P4M  | 1/4" NPT male            | \$33.55                |
|                                | P2M  | 1/2" NPT male            | \$33.55                |
|                                | P3M  | 3/4" NPT male            | \$33.55                |
|                                | P1M  | 1" NPT male              | \$33.55                |
| 1                              | ???  | Other - please specify   | on inquiry             |
| <b>Nominal pressure rating</b> |      |                          |                        |
|                                | P3   | 2500 psi MWP             | N/C                    |
| 2                              | ??   | Other - please specify   | on inquiry             |
| <b>Upper housing material</b>  |      |                          |                        |
|                                | C2   | 316L SS (1.4435)         | \$222.80               |
|                                | M1   | Monel® 400 (2.4360)      | on inquiry             |
| 3                              | ??   | Other - please specify   | on inquiry             |
| <b>Diaphragm material</b>      |      | <b>Add. price</b>        |                        |
|                                | C2   | 316L SS (1.4435)         | N/C                    |
|                                | H2   | Hastelloy® C276 (2.4819) | \$11.75                |
|                                | M1   | Monel® 400 (2.4360)      | \$14.80                |
|                                | C0   | Carpenter 20             | \$11.75                |
| 4                              | ??   | Other - please specify   | on inquiry             |
| <b>Lower housing material</b>  |      | <b>Female</b>            | <b>Male</b>            |
|                                | C2   | 316 L SS (1.4435)        | N/C                    |
|                                | H2   | Hastelloy® C276 (2.4819) | \$651.00   \$1,324.00  |
|                                | M1   | Monel® 400 (2.4360)      | on inquiry             |
|                                | C0   | Carpenter 20             | on inquiry             |
| 5                              | ??   | Other - please specify   | on inquiry             |
| <b>Flushing connection</b>     |      | <b>C2</b>                | <b>other materials</b> |
|                                | Z    | Without                  | on inquiry             |
|                                | 1    | 1 x 1/8" NPT female      | \$57.20   on inquiry   |
|                                | 2    | 1 x 1/4" NPT female      | \$57.20   on inquiry   |
| 6                              | ?    | Other - please specify   | on inquiry             |

DIAPHRAGM SEALS

Order Code:      1            2            3            4            5            6

**990.TB-**       **ZZZ**

\*Additional order details \_\_\_\_\_  
(see Page 229)

# THREADED SEALS

Diaphragm Seals > Threaded Seals > 990.10

| 990.10 Smart Code Configuration |                                |   |                        |
|---------------------------------|--------------------------------|---|------------------------|
| Field no.                       | Code                           | List price  |                        |
| 1                               | <b>Process connection</b>      |   |                        |
|                                 | P4F                            | 1/4" NPT female                                     | \$136.30               |
|                                 | P2F                            | 1/2" NPT female                                     | \$136.30               |
|                                 | P3F                            | 3/4" NPT female                                     | \$136.30               |
|                                 | P1F                            | 1" NPT female                                       | \$136.30               |
|                                 | P4M                            | 1/4" NPT male                                       | \$245.50               |
|                                 | P2M                            | 1/2" NPT male                                       | \$245.50               |
|                                 | P3M                            | 3/4" NPT male                                       | \$245.50               |
|                                 | P1M                            | 1" NPT male   | \$245.50               |
|                                 | ???                            | Other - please specify                              | on inquiry             |
| 2                               | <b>Nominal pressure rating</b> |   |                        |
|                                 | P1                             | 200 psi MWP (PTFE lower only) <sup>1</sup>          | N/C                    |
|                                 | P2                             | 1,500 psi MWP (4 bolt design)                       | N/C                    |
|                                 | P4                             | 3,675 psi MWP (8 bolt design) <sup>2</sup>          | \$105.10               |
| ??                              | Other - please specify         | on inquiry  |                        |
| 3                               | <b>Upper housing material</b>  |   |                        |
|                                 | CS                             | Carbon steel 1018, nickel-plated                    | N/C                    |
|                                 | C2                             | 316L SS (1.4435)                                    | \$95.90                |
|                                 | C5                             | 316 Ti SS (1.4571)                                  | \$95.90                |
|                                 | T1                             | Titanium grade 2 (3.7035) <sup>3</sup>              | \$759.00               |
|                                 | ??                             | Other - please specify                              | on inquiry             |
| 4                               | <b>Diaphragm material</b>      |   |                        |
|                                 | C2                             | 316L SS (1.4435)                                    | N/C                    |
|                                 | H3                             | Hastelloy® B2 (2.4617)                              | \$40.40                |
|                                 | H2                             | Hastelloy® C276 (2.4819)                            | \$40.40                |
|                                 | M1                             | Monel® 400 (2.4360)                                 | \$24.10                |
|                                 | I1                             | Inconel® 600 (2.4816)                               | \$32.95                |
|                                 | I2                             | Incoloy 825 (2.4858)                                | \$32.95                |
|                                 | TL                             | Tantalum  | \$97.45                |
|                                 | NL                             | Nickel  | \$31.55                |
|                                 | T1                             | Titanium grade 2 (3.7035) <sup>3</sup>              | \$48.10                |
|                                 | C0                             | Carpenter 20  | \$32.95                |
|                                 | CP                             | 316L SS with PTFE-lining                            | \$51.05                |
|                                 | CF                             | 316L SS with PFA-coating                            | \$33.10                |
|                                 | CG                             | 316L SS w/ gold plating <sup>4</sup>                | on inquiry             |
|                                 | ??                             | Other - please specify                              | on inquiry             |
|                                 | 5                              | <b>Lower housing material</b>                       |                        |
| CS                              |                                | Carbon steel 1018 nickel plating                    | N/C                    |
| C2                              |                                | 316L SS (1.4435)                                    | \$174.70   \$150.60    |
| H3                              |                                | Hastelloy® B2 (2.4617)                              | on inquiry             |
| H4                              |                                | Hastelloy® B3 (2.4600)                              | on inquiry             |
| H2                              |                                | Hastelloy® C276 (2.4819)                            | \$1,452.00   \$923.00  |
| M1                              |                                | Monel® 400 (2.4360)                                 | \$821.00   \$521.00    |
| I1                              |                                | Inconel® 600 (2.4816)                               | on inquiry             |
| I2                              |                                | Incoloy 825 (2.4858)                                | on inquiry             |
| NL                              |                                | Nickel  | \$1386.50   \$2,183.40 |
| T1                              |                                | Titanium grade 2 (3.7035)                           | \$1,195.00   \$759.00  |
| PT                              |                                | Solid Polytetrafluoroethylene <sup>1,5</sup> (PTFE) | N/A   \$398.00         |
| C0                              |                                | Carpenter 20  | on inquiry             |
| ??                              |                                | Other - please specify                              | on inquiry             |

| 990.10 Smart Code Configuration |  |  |            |          |          |            |
|---------------------------------|--|--|------------|----------|----------|------------|
| Field no.                       | Code   | List price   |            |          |          |            |
| 6                               | <b>Gasket material</b>                               |  |            |          |          |            |
|                                 | Z  | Without (PTFE lower only) <sup>1</sup>                 | N/C        |          |          |            |
|                                 | N  | BUNA-N (NBR) max. 212 °F                               | N/C        |          |          |            |
|                                 | V  | Viton® (FPM) max. 400 °F                               | N/C        |          |          |            |
|                                 | P  | Teflon® (PTFE) max. 500 °F                             | \$10.55    |          |          |            |
|                                 | D  | Metal seal form C (SS/silver) 752°F <sup>2</sup>       | \$196.30   |          |          |            |
|                                 | G  | Metal seal form C (Inconel®/silver) 752°F <sup>2</sup> | \$196.30   |          |          |            |
|                                 | ?  | Other - please specify                                 | on inquiry |          |          |            |
| 7                               | <b>Fastening parts (retainer flange &amp; bolts)</b> |  |            |          |          |            |
|                                 | G  | Galvanized steel                                       | N/C        |          |          |            |
|                                 | P  | Stainless steel  | \$127.15   |          |          |            |
|                                 | C  | SS with high tensile bolts <sup>2</sup>                | \$287.45   |          |          |            |
| ?                               | Other - please specify                               | on inquiry   |            |          |          |            |
| 8                               | <b>Flushing connection</b>                           |  |            |          |          |            |
|                                 | Z  | Without  | C2         | M1       | H2       | other      |
|                                 | 1  | 1 x 1/8" NPT female                                    | \$39.95    | \$58.90  | \$79.55  | on inquiry |
|                                 | 2  | 1 x 1/4" NPT female                                    | \$39.95    | \$58.90  | \$79.55  | on inquiry |
|                                 | 4  | 2 x 1/8" NPT female                                    | \$79.70    | \$117.50 | \$159.10 | on inquiry |
|                                 | 5  | 2 x 1/4" NPT female                                    | \$79.850   | \$117.50 | \$159.10 | on inquiry |
| ?                               | Other - please specify                               | on inquiry   |            |          |          |            |

<sup>1</sup> These options are exclusive to the solid PTFE lower housing (max. 300 °F)

<sup>2</sup> Required for high temperature applications up to 752 °F

<sup>3</sup> Titanium diaphragm requires titanium upper housing

<sup>4</sup> Gold plated 50 micro-inches

<sup>5</sup> No flushing ports available



DIAPHRAGM SEALS

Order Code:      1      2      3      4      5      6      7      8

**990.10-**         **ZZZ**

\*Additional order details \_\_\_\_\_  
(see Page 229)

# THREADED SEALS

Diaphragm Seals > Threaded Seals > 990.TC

| 990.TC Smart Code Configuration |                                |                                   |                                   |             |               |
|---------------------------------|--------------------------------|-----------------------------------|-----------------------------------|-------------|---------------|
| Field no.                       | Code                           | List price                        |                                   |             |               |
| 1                               | <b>Process connection</b>      |                                   |                                   |             |               |
|                                 | P4F                            | 1/4" NPT female                   | \$136.30                          |             |               |
|                                 | P2F                            | 1/2" NPT female                   | \$136.30                          |             |               |
|                                 | P3F                            | 3/4" NPT female                   | \$136.30                          |             |               |
|                                 | P1F                            | 1" NPT female                     | \$136.30                          |             |               |
|                                 | P4M                            | 1/4" NPT male                     | \$245.50                          |             |               |
|                                 | P2M                            | 1/2" NPT male                     | \$245.50                          |             |               |
|                                 | P3M                            | 3/4" NPT male                     | \$245.50                          |             |               |
|                                 | P1M                            | 1" NPT male                       | \$136.30                          |             |               |
| 1                               | ???                            | Other - please specify on inquiry |                                   |             |               |
| 2                               | <b>Nominal pressure rating</b> |                                   |                                   |             |               |
|                                 | P2                             | 1,500 psi MWP (4 bolt design)     | N/C                               |             |               |
|                                 | P3                             | 2,500 psi MWP (8 bolt design)     | \$105.10                          |             |               |
| 2                               | ??                             | Other - please specify on inquiry |                                   |             |               |
| 3                               | <b>Upper housing material</b>  |                                   |                                   |             |               |
|                                 | CS                             | Carbon steel 1018, nickel-plated  | N/C                               |             |               |
|                                 | C2                             | 316L SS (1.4435)                  | \$95.90                           |             |               |
| 3                               | ??                             | Other - please specify on inquiry |                                   |             |               |
| 4                               | <b>Diaphragm material</b>      |                                   |                                   |             |               |
|                                 | C2                             | 316L SS (1.4435)                  | N/C                               |             |               |
|                                 | H3                             | Hastelloy® B3 (2.4600)            | \$40.40                           |             |               |
|                                 | H2                             | Hastelloy® C276 (2.4819)          | \$40.40                           |             |               |
|                                 | M1                             | Monel® 400 (2.4360)               | \$24.10                           |             |               |
|                                 | I1                             | Inconel® 600 (2.4816)             | \$32.95                           |             |               |
|                                 | I2                             | Incoloy 825 (2.4858)              | \$32.95                           |             |               |
|                                 | TL                             | Tantalum                          | \$97.45                           |             |               |
|                                 | NL                             | Nickel                            | \$32.95                           |             |               |
|                                 | T1                             | Titanium grade 2 (3.7035)         | \$48.10                           |             |               |
|                                 | C0                             | Carpenter 20                      | \$32.95                           |             |               |
|                                 | VI                             | Viton® (FPM Grade A) max 400 °F   | \$51.05                           |             |               |
|                                 | CP                             | 316L SS with PTFE-lining          | \$51.05                           |             |               |
|                                 | CF                             | 316L SS with PFA-coating          | \$32.95                           |             |               |
|                                 | 4                              | ??                                | Other - please specify on inquiry |             |               |
|                                 | 5                              | <b>Lower housing material</b>     |                                   |             |               |
|                                 |                                |                                   |                                   | <b>Male</b> | <b>Female</b> |
|                                 |                                | CS                                | Carbon steel 1018 nickel plating  | N/C         |               |
|                                 |                                | C5                                | 316 TI SS (1.4571)                | \$173.80    | \$144.00      |
| C2                              |                                | 316L SS (1.4435)                  | \$173.80                          | \$144.00    |               |
| H3                              |                                | Hastelloy® B2 (2.4617)            | on inquiry                        |             |               |
| H4                              |                                | Hastelloy® B3 (2.4600)            | on inquiry                        |             |               |
| H2                              |                                | Hastelloy® C276 (2.4819)          | \$1,452.00                        | \$923.00    |               |
| M1                              |                                | Monel® 400 (2.4360)               | \$821.00                          | \$521.00    |               |
| I1                              |                                | Inconel® 600 (2.4816)             | on inquiry                        |             |               |
| I2                              |                                | Incoloy 825 (2.4858)              | on inquiry                        |             |               |
| T1                              |                                | Titanium grade 2 (3.7035)         | \$1,195.00                        | \$759.00    |               |
| C0                              |                                | Carpenter 20                      | on inquiry                        |             |               |
| 5                               |                                | ??                                | Other - please specify on inquiry |             |               |

| 990.TC Smart Code Configuration |  |                                   |           |           |              |            |
|---------------------------------|--|-----------------------------------|-----------|-----------|--------------|------------|
| Field no.                       | Code   | List price                        |           |           |              |            |
| 6                               | <b>Gasket material</b>                             |                                   |           |           |              |            |
|                                 | G  | BUNA-N (NBR) max. 212 °F          | N/C       |           |              |            |
|                                 | J  | Viton® (FPM) max. 400 °F          | N/C       |           |              |            |
|                                 | E  | Teflon® (PTFE) max. 500 °F        | \$20.60   |           |              |            |
|                                 | ?  | Other - please specify on inquiry |           |           |              |            |
| 7                               | <b>Fastening parts (retainer flange and bolts)</b> |                                   |           |           |              |            |
|                                 | G  | Galvanized steel                  | N/C       |           |              |            |
|                                 | P  | Stainless steel                   | \$124.30  |           |              |            |
| 7                               | ?  | Other - please specify on inquiry |           |           |              |            |
| 8                               | <b>Flushing connection</b>                         |                                   |           |           |              |            |
|                                 |  | <b>C2</b>                         | <b>M1</b> | <b>H2</b> | <b>other</b> |            |
|                                 | 1  | Without                           | N/C       |           |              |            |
|                                 | 2  | 1 x 1/8" NPT female               | \$39.95   | \$58.90   | \$79.55      | on inquiry |
|                                 | 3  | 1 x 1/4" NPT female               | \$39.95   | \$58.90   | \$79.55      | on inquiry |
|                                 | 4  | 2 x 1/8" NPT female               | \$79.70   | \$117.50  | \$159.10     | on inquiry |
|                                 | 5  | 2 x 1/4" NPT female               | \$79.85   | \$117.50  | \$159.10     | on inquiry |
| 8                               | ?  | Other - please specify on inquiry |           |           |              |            |



DIAPHRAGM SEALS

Order Code:      1      2      3      4      5      6      7      8

**990.TC** - 

|  |  |  |  |  |  |  |  |
|--|--|--|--|--|--|--|--|
|  |  |  |  |  |  |  |  |
|--|--|--|--|--|--|--|--|

**ZZZ**

\*Additional order details \_\_\_\_\_  
(see Page 229)

# THREADED SEALS

Diaphragm Seals > Threaded Seals > 990.40

| 990.40 Smart Code Configuration |                           |  |                                 |     |
|---------------------------------|---------------------------|--|---------------------------------|-----|
| Field no.                       | Code                      | List price                             |                                 |     |
| <b>Process connection</b>       |                           |  |                                 |     |
| 1                               | P4F                       | ¼" NPT female                          | N/C                             |     |
|                                 | P2F                       | ½" NPT female                          | N/C                             |     |
|                                 | P3F                       | ¾" NPT female                          | N/C                             |     |
|                                 | P1F                       | 1" NPT female                          | N/C                             |     |
|                                 | P2M                       | ½" NPT male                            | \$44.10                         |     |
|                                 | P3M                       | ¾" NPT male                            | \$73.85                         |     |
|                                 | P1M                       | 1" NPT male                            | \$73.85                         |     |
|                                 | ???                       | Other - please specify                 | on inquiry                      |     |
| <b>Nominal pressure rating</b>  |                           |  |                                 |     |
| 2                               | P1                        | 200 psi MWP for 4.9" diaphragm         | \$1514.15                       |     |
|                                 | P2                        | 1,500 psi MWP for 3.5" diaphragm       | \$1096.45                       |     |
|                                 | ??                        | Other - please specify                 | on inquiry                      |     |
| <b>Upper housing material</b>   |                           |  |                                 |     |
| 3                               | CS                        | Carbon steel 1018 nickel-plated        | \$181.30                        |     |
|                                 | C2                        | 316L SS (1.4435)                       | N/C                             |     |
|                                 | T1                        | Titanium grade 2 (3.7035) <sup>1</sup> | on inquiry                      |     |
|                                 | ??                        | Other - please specify                 | on inquiry                      |     |
|                                 | <b>Diaphragm material</b> |  |                                 |     |
|                                 | 4                         | C2                                     | 316L SS (1.4435)                | N/C |
| H3                              |                           | Hastelloy® B2 (2.4617)                 | on inquiry                      |     |
| H2                              |                           | Hastelloy® C276 (2.4819)               | \$119.30                        |     |
| M1                              |                           | Monel® 400 (2.4360)                    | \$107.90                        |     |
| I1                              |                           | Inconel® 600 (2.4816)                  | \$132.05                        |     |
| I2                              |                           | Incoloy 825 (2.4858)                   | \$132.05                        |     |
| TL                              |                           | Tantalum                               | \$222.30                        |     |
| NL                              |                           | Nickel 200 (2.4066)                    | on inquiry                      |     |
| T1                              |                           | Titanium grade 2 (3.7035) <sup>1</sup> | on inquiry                      |     |
| C0                              |                           | Carpenter 20                           | \$212.30                        |     |
| CP                              |                           | 316L SS with PTFE-lining               | \$583.75                        |     |
| CF                              |                           | 316L SS with PFA-coating               | \$591.60                        |     |
| CG                              |                           | 316L SS w/ gold plating <sup>2</sup>   | on inquiry                      |     |
| ??                              |                           | Other - please specify                 | on inquiry                      |     |
| <b>Lower housing material</b>   |                           |  |                                 |     |
| 5                               |                           | CS                                     | Carbon steel 1018 nickel-plated | N/C |
|                                 |                           | C2                                     | 316L SS (1.4435)                | N/C |
|                                 | H3                        | Hastelloy® B2 (2.4617)                 | on inquiry                      |     |
|                                 | H4                        | Hastelloy® B3 (2.4600)                 | on inquiry                      |     |
|                                 | H2                        | Hastelloy® C276 (2.4819)               | on inquiry                      |     |
|                                 | M1                        | Monel® 400 (2.4360)                    | on inquiry                      |     |
|                                 | I1                        | Inconel® 600 (2.4816)                  | on inquiry                      |     |
|                                 | I2                        | Incoloy 825 (2.4858)                   | on inquiry                      |     |
|                                 | T1                        | Titanium grade 2 (3.7035)              | on inquiry                      |     |
|                                 | C0                        | Carpenter 20                           | on inquiry                      |     |
| ??                              | Other - please specify    | on inquiry                             |                                 |     |

| 990.40 Smart Code Configuration         |      |  |              |
|---|------|--|--------------|
| Field no.                               | Code | List price   |              |
| <b>Gasket material</b>                  |      |  |              |
| 6                                       | V    | Viton® (FPM) max. 400 °F                                 | N/C          |
|   | P    | Teflon® (PTFE) max. 500 °F                               | \$18.60      |
|   | C    | Metal seal form C, (SS/silver) 752 °F <sup>3</sup>       | on inquiry   |
|   | G    | Metal seal form C, (Inconel®/silver) 752 °F <sup>3</sup> | on inquiry   |
|   | ?    | Other - please specify                                   | on inquiry   |
| <b>Fastening parts material (bolts)</b> |      |  |              |
| 7                                       | P    | Stainless steel bolts                                    | \$120.75     |
|   | C    | Stainless steel high tensile bolts                       | \$272.30     |
|   | ?    | Other - please specify                                   | on inquiry   |
| <b>Flushing connection</b>              |      |  |              |
| 8                                       | Z    | Without  | N/C          |
|   | 2    | 1 x ¼" NPT female  | \$85.15      |
|   | 5    | 2 x ¼" NPT female  | \$168.90     |
|   | ?    | Other - please specify                                   | on inquiry   |
|   |      |  | <b>other</b> |

<sup>1</sup> Titanium diaphragm requires titanium upper housing

<sup>2</sup> Gold plated 50 micro-inches

<sup>3</sup> For high temperature applications up to 752 °F



DIAPHRAGM SEALS

Order Code:    1        2        3        4        5        6        7        8

**990.40 -**         **ZZZ**

\*Additional order details \_\_\_\_\_  
(see Page 229)

# THREADED SEALS

Diaphragm Seals > Threaded Seals > 990.34

## 990.34 Smart Code Configuration

| Field no.                      | Code                                    | List price                             |            |            |
|--------------------------------|---|--|------------|------------|
| <b>Process connection</b>      |   |  |            |            |
| 1                              | P4F                                     | ¼" NPT female                          | N/C        |            |
|                                | P3F                                     | ½" NPT female                          | N/C        |            |
|                                | P4M                                     | ¼" NPT male                            | N/C        |            |
|                                | P2M                                     | ½" NPT male                            | N/C        |            |
|                                | ???                                     | Other - please specify                 | on inquiry |            |
| <b>Nominal pressure rating</b> |   |  |            |            |
| 2                              | P2                                      | 1,500 psi MWP (2.1" diaphragm)         | \$272.40   |            |
|                                | P5                                      | 5,000 psi MWP (2.1" diaphragm)         | \$304.20   |            |
|                                | P6                                      | 9,000 psi MWP (1.3" diaphragm)         | \$352.55   |            |
|                                | ??                                      | Other - please specify                 | on inquiry |            |
| <b>Upper housing material</b>  |   |  |            |            |
| 3                              | C2                                      | 316L SS (1.4435)                       | N/C        |            |
|                                | T1                                      | Titanium grade 2 (3.7035) <sup>2</sup> | on inquiry |            |
|                                | ??                                      | Other - please specify                 | on inquiry |            |
| <b>Wetted parts material</b>   |   | <b>Female Male</b>                     |            |            |
| 4                              | C2-C2                                   | 316L SS (1.4435)                       | N/C        |            |
|                                | H3-H3                                   | Hastelloy® B2 (2.4617)                 | on inquiry |            |
|                                | H4-H4                                   | Hastelloy® B3 (2.4600)                 | on inquiry |            |
|                                | H2-H2                                   | Hastelloy® C276 (2.4819)               | \$799.00   | \$1,489.00 |
|                                | M1-M1                                   | Monel® 400 (2.4360)                    | \$572.00   | \$924.00   |
|                                | I1-I1                                   | Inconel® 600 (2.4816)                  | on inquiry |            |
|                                | I2-I2                                   | Incoloy 825 (2.4858)                   | on inquiry |            |
|                                | T1-T1                                   | Titanium grade 2 (3.7035) <sup>1</sup> | on inquiry |            |
|                                | ????                                    | Other - please specify                 | on inquiry |            |
|                                | <b>Flushing connection <sup>2</sup></b> |  |            |            |
| 5                              | Z                                       | Without                                | N/C        |            |
|                                | 2                                       | 1 x ¼" NPT female                      | \$42.50    |            |
|                                | 5                                       | 2 x ¼" NPT female                      | \$84.90    |            |
|                                | ?                                       | Other - please specify                 | on inquiry |            |



9,000 psi



1,500/5,000 psi

DIAPHRAGM SEALS

<sup>1</sup> Selection of titanium require full titanium design, only threaded instrument connections available

<sup>2</sup> Only for 1,500 psi MWP and 5,000 MWP designs

Order Code:      1      2      3      4      5

**990.34** -      **ZZZ**

\*Additional order details \_\_\_\_\_  
(see Page 229)



# THREADED SEALS

Diaphragm Seals > Threaded Seals > 990.36

| 990.36 Smart Code Configuration |                           |  |                       |
|---------------------------------|---------------------------|--|-----------------------|
| Field no.                       | Code                      | List price                             |                       |
| 1                               | <b>Process connection</b> |  |                       |
|                                 | P3M                       | ¾" NPT male                            | 324.00                |
|                                 | P1M                       | 1" NPT male                            | 317.95                |
|                                 | PMM                       | 1½" NPT male                           | 362.35                |
|                                 | P5M                       | 2" NPT male                            | 390.15                |
|                                 | GDA                       | G ¾" male                              | 340.20                |
|                                 | G1M                       | G 1" male                              | 317.95                |
|                                 | GMM                       | G 1½" male                             | 362.35                |
|                                 | ???                       | Other - please specify                 | on inquiry            |
|                                 | 2                         | <b>Housing and diaphragm material</b>  |                       |
| C2-C2                           |                           | 316L SS (1.4435)                       | N/C                   |
| H3-H3                           |                           | Hastelloy® B2 (2.4617)                 | on inquiry            |
| H4-H4                           |                           | Hastelloy® B3 (2.4600)                 | on inquiry            |
| H2-H2                           |                           | Hastelloy® C276 (2.4819)               | \$799.00   \$1,489.00 |
| M1-M1                           |                           | Monel® 400 (2.4360)                    | \$572.00   \$924.00   |
| I1-I1                           |                           | Inconel® 600 (2.4816)                  | on inquiry            |
| I2-I2                           |                           | Incoloy 825 (2.4858)                   | on inquiry            |
| T1-T1                           |                           | Titanium grade 2 (3.7035) <sup>1</sup> | on inquiry            |
| ????                            |                           | Other - please specify                 | on inquiry            |



<sup>1</sup> Selection of titanium require full titanium design, only threaded instrument connections available

Order Code:            1                            2

**990.36 -**   **ZZZ**

\*Additional order details \_\_\_\_\_  
(see Page 229)

# FLANGED SEALS

Diaphragm Seals > Flanged Seals > 990.12

DIAPHRAGM SEALS

| 990.12 Smart Code Configuration |                                |   |                               |                 |
|---------------------------------|--------------------------------|---|-------------------------------|-----------------|
| Field no.                       | Code                           | List price                                    |                               |                 |
| 1                               | <b>Process connection type</b> |   |                               |                 |
|                                 | A                              | ASME B16.5                                    | N/C                           |                 |
|                                 | ?                              | Other - please specify                        | on inquiry                    |                 |
| 2                               | <b>Process connection</b>      |   |                               |                 |
|                                 | SM05                           | ½"  | \$99.25                       |                 |
|                                 | SM07                           | ¾"  | \$99.25                       |                 |
|                                 | SM10                           | 1"  | \$117.75                      |                 |
|                                 | SM15                           | 1½"   | \$160.50                      |                 |
|                                 | SM20                           | 2"  | \$335.35                      |                 |
|                                 | ????                           | Other - please specify                        | on inquiry                    |                 |
| 3                               | <b>Nominal pressure rating</b> |   | <b>Multiplier for Field 2</b> |                 |
|                                 | 1                              | Class 150                                     | 1.00                          |                 |
|                                 | 2                              | Class 300                                     | 1.30                          |                 |
|                                 | 4                              | Class 600                                     | 1.60                          |                 |
|                                 | 5                              | Class 900                                     | 2.80                          |                 |
|                                 | 6                              | Class 1500                                    | 2.80                          |                 |
|                                 | ?                              | Other - please specify                        | on inquiry                    |                 |
| 4                               | <b>Sealing face style</b>      |   |                               |                 |
|                                 | 1B                             | Raised Face 125 ... 250 RMS                   | \$151.70                      |                 |
|                                 | 1F                             | Ring (Type) Joint (RTJ / RJF)                 | \$185.90                      |                 |
|                                 | SF                             | Raised Face Smooth Finish (RFSF) <sup>1</sup> | \$151.70                      |                 |
| ??                              | Other - please specify         | on inquiry                                    |                               |                 |
| 5                               | <b>Upper housing material</b>  |   |                               |                 |
|                                 | CS                             | Carbon steel 1018 nickel-plated               | N/C                           |                 |
|                                 | C2                             | 316L SS (1.4435)                              | \$95.90                       |                 |
|                                 | T1                             | Titanium grade 2 (3.7035) <sup>2</sup>        | \$759.00                      |                 |
|                                 | ??                             | Other - please specify                        | on inquiry                    |                 |
| 6                               | <b>Diaphragm material</b>      |   |                               |                 |
|                                 | C2                             | 316L SS (1.4435)                              | N/C                           |                 |
|                                 | H3                             | Hastelloy® B2 (2.4617)                        | \$40.40                       |                 |
|                                 | H2                             | Hastelloy® C276 (2.4819)                      | \$40.40                       |                 |
|                                 | M1                             | Monel® 400 (2.4360)                           | \$24.10                       |                 |
|                                 | I1                             | Inconel® 600 (2.4816)                         | \$32.95                       |                 |
|                                 | I2                             | Incoloy 825 (2.4858)                          | \$32.95                       |                 |
|                                 | TL                             | Tantalum                                      | \$97.45                       |                 |
|                                 | NL                             | Nickel  | \$31.55                       |                 |
|                                 | AE                             | Titanium grade 2 (3.7035) <sup>2</sup>        | \$48.10                       |                 |
|                                 | C0                             | Carpenter 20                                  | \$32.95                       |                 |
|                                 | CP                             | 316L SS with PTFE-lining                      | \$51.05                       |                 |
|                                 | CF                             | 316L SS with PFA-coating                      | \$33.10                       |                 |
|                                 | CG                             | 316L SS w/ gold plating <sup>3</sup>          | on inquiry                    |                 |
|                                 | ??                             | Other - please specify                        | on inquiry                    |                 |
|                                 | <b>Lower housing material</b>  |   | <b>Up to 1"</b>               | <b>up to 2"</b> |
|                                 | CS                             | Carbon steel 1018 nickel-plated               | N/C                           | \$157.10        |
| C2                              | 316L SS (1.4435)               | \$167.25                                      | \$175.80                      |                 |
| H3                              | Hastelloy® B2 (2.4617)         | on inquiry                                    |                               |                 |
| H4                              | Hastelloy® B3 (2.4600)         | on inquiry                                    |                               |                 |
| H2                              | Hastelloy® C276 (2.4819)       | 1,528.00                                      | 2,469.00                      |                 |
| M1                              | Monel® 400 (2.4360)            | 1,065.00                                      | 1,533.00                      |                 |
| I1                              | Inconel® 600 (2.4816)          | on inquiry                                    |                               |                 |
| I2                              | Incoloy 825 (2.4858)           | on inquiry                                    |                               |                 |
| TL                              | Tantalum-lined <sup>1,4</sup>  | on inquiry                                    |                               |                 |

| 990.12 Smart Code Configuration |  |   |            |           |           |              |
|---------------------------------|--|---|------------|-----------|-----------|--------------|
| Field no.                       | Code   | List price  |            |           |           |              |
| 7                               | NL   | Nickel  | on inquiry |           |           |              |
|                                 | T1   | Titanium grade 2 (3.7035)                                 | on inquiry |           |           |              |
|                                 | C0   | Carpenter 20  | on inquiry |           |           |              |
|                                 | CW   | 316L SS with virgin PTFE-lining <sup>1,4</sup>            | on inquiry |           |           |              |
|                                 | CF   | 316L SS with PFA-coating <sup>1,4</sup>                   | on inquiry |           |           |              |
| ??                              | Other - please specify                               | on inquiry  |            |           |           |              |
| 8                               | <b>Gasket material</b>                               |   |            |           |           |              |
|                                 | Z  | Without (PTFE/PFA coated lower only)                      | N/C        |           |           |              |
|                                 | N  | BUNA-N (NBR) max. 212 °F                                  | N/C        |           |           |              |
|                                 | V  | Viton® (FPM) max. 400 °F                                  | N/C        |           |           |              |
|                                 | P  | Teflon® (PTFE) max. 500 °F                                | \$10.55    |           |           |              |
|                                 | C  | Metal form C, (SS / silver) max. 752°F <sup>5</sup>       | on inquiry |           |           |              |
|                                 | G  | Metal form C, (Inconel® / silver) max. 752°F <sup>5</sup> | on inquiry |           |           |              |
| ?                               | Other - please specify                               | on inquiry  |            |           |           |              |
| 9                               | <b>Fastening parts (retainer flange &amp; bolts)</b> |   |            |           |           |              |
|                                 | G  | Galvanized steel  | N/C        |           |           |              |
|                                 | P  | Stainless steel   | \$104.95   |           |           |              |
|                                 | C  | Stainless steel with high tensile bolts <sup>5</sup>      | \$104.95   |           |           |              |
| ?                               | Other - please specify                               | on inquiry  |            |           |           |              |
| 10                              | <b>Flushing connection</b>                           |   | <b>C2</b>  | <b>M1</b> | <b>H2</b> | <b>other</b> |
|                                 | Z  | Without   | N/C        |           |           |              |
|                                 | 1  | 1 x ½" NPT female   | 79.60      | 120.05    | 161.20    | on inquiry   |
|                                 | 2  | 1 x ¼" NPT female   | 79.60      | 120.05    | 161.20    | on inquiry   |
|                                 | 4  | 2 x ½" NPT female   | 157.65     | 240.15    | 336.35    | on inquiry   |
|                                 | 5  | 2 x ¼" NPT female   | 157.65     | 240.15    | 336.35    | on inquiry   |
|                                 | ?  | Other - please specify                                    | on inquiry |           |           |              |
| 11                              | <b>Flushing connection sealing screws</b>            |   |            |           |           |              |
|                                 | Z  | Without   | N/C        |           |           |              |
| 1                               | With sealing screw(s)                                | on inquiry  |            |           |           |              |

<sup>1</sup> RFSF sealing face required lined/coated lower housings

<sup>2</sup> Titanium diaphragm requires titanium upper housing

<sup>3</sup> Gold plating 50 micro-inches

<sup>4</sup> No flushing ports available

<sup>5</sup> For high temperature applications up to 752 °F



\*Additional order details (see Page 229)

Order Code:      1      2      3      4      5      6      7      8      9      10      11

**990.12 -**

**ZZZ ZZZ**

# FLANGED SEALS

Diaphragm Seals > Flanged Seals > 990.FA

| 990.FA Smart Code Configuration |  |            |
|---------------------------------|--|------------|
| Field no.                       | Code   | List price |
| 1                               | <b>Process connection type</b>                   |            |
|                                 | A ASME B16.5                                     | N/C        |
|                                 | ? Other - please specify                         | on inquiry |
| 2                               | <b>Process connection</b>                        |            |
|                                 | SM05 ½"  | \$99.25    |
|                                 | SM07 ¾"  | \$99.25    |
|                                 | SM10 1"  | \$117.75   |
|                                 | SM15 1½"   | \$160.50   |
|                                 | SM20 2"  | \$335.35   |
|                                 | ???? Other - please specify                      | on inquiry |
| 3                               | <b>Nominal pressure rating</b>                   |            |
|                                 | 1 Class 150                                      | 1.00       |
|                                 | 2 Class 300                                      | 1.30       |
|                                 | 4 Class 600                                      | 1.60       |
|                                 | 5 Class 900                                      | 2.80       |
|                                 | 6 Class 1500                                     | 2.80       |
|                                 | ? Other - please specify                         | on inquiry |
| 4                               | <b>Sealing face style</b>                        |            |
|                                 | 1B Raised Face 125 ... 250 RMS                   | \$151.70   |
|                                 | 1F Ring (Type) Joint (RTJ / RJF)                 | \$185.90   |
|                                 | SF Raised Face Smooth Finish (RFSF) <sup>1</sup> | \$151.70   |
| 5                               | <b>Upper housing material</b>                    |            |
|                                 | CS Carbon steel 1018 nickel-plated               | N/C        |
|                                 | C2 316L SS (1.4435)                              | \$95.90    |
|                                 | ?? Other - please specify                        | on inquiry |
|                                 | <b>Diaphragm material</b>                        |            |
|                                 | C2 316L SS (1.4435)                              | N/C        |
|                                 | H3 Hastelloy® B2 (2.4617)                        | \$40.40    |
|                                 | H4 Hastelloy® B3 (2.4600)                        | \$40.40    |
|                                 | H2 Hastelloy® C276 (2.4819)                      | \$40.40    |
|                                 | M1 Monel® 400 (2.4360)                           | \$24.10    |
|                                 | I1 Inconel® 600 (2.4816)                         | \$32.95    |
|                                 | I2 Incoloy 825 (2.4858)                          | \$32.95    |
|                                 | TL Tantalum                                      | \$97.45    |
| 6                               | NL Nickel  | \$31.55    |
|                                 | T1 Titanium grade 2 (3.7035)                     | \$48.10    |
|                                 | C0 Carpenter 20                                  | \$32.95    |
|                                 | VI Viton® (FPM)-max. 400 °F                      | \$32.95    |
|                                 | CP 316L SS with PTFE-lining                      | \$51.05    |
|                                 | CF 316L SS with PFA-coating                      | \$32.95    |
|                                 | ?? Other - please specify                        | on inquiry |

| 990.FA Smart Code Configuration                   |   |                 |            |            |           |              |
|---|---|-----------------|------------|------------|-----------|--------------|
| Field no.   | Code  | List price      |            |            |           |              |
| 7   | <b>Lower housing material</b>                                 |                 |            |            |           |              |
|   | CS Carbon steel 1018 nickel-plated                            | N/C             | on inquiry |            |           |              |
|   | C2 316L SS (1.4435)   | 171.40          | 185.40     |            |           |              |
|   | H3 Hastelloy® B2 (2.4617)                                     | on inquiry      |            |            |           |              |
|   | H4 Hastelloy® B3 (2.4600)                                     | on inquiry      |            |            |           |              |
|   | H2 Hastelloy® C276 (2.4819)                                   | 1,715.00        | 2,469.00   |            |           |              |
|   | M1 Monel® 400 (2.4360)  | 1,054.00        | 1,533.00   |            |           |              |
|   | I1 Inconel® 600 (2.4816)                                      | on inquiry      |            |            |           |              |
|   | I2 Incoloy 825 (2.4858)                                       | on inquiry      |            |            |           |              |
|   | AB Tantalum lining <sup>1,2</sup>                             | 1,365.00        | 2,166.00   |            |           |              |
|   | NL Nickel   | on inquiry      |            |            |           |              |
|   | T1 Titanium grade 2 (3.7035)                                  | on inquiry      |            |            |           |              |
|   | 8   | C0 Carpenter 20 | on inquiry |            |           |              |
| CW 316L SS with virgin PTFE-lining <sup>1,2</sup> |   | on inquiry      |            |            |           |              |
| CF 316L SS with PFA-coating <sup>1,2</sup>        |   | on inquiry      |            |            |           |              |
| ?? Other - please specify                         |   | on inquiry      |            |            |           |              |
| <b>Gasket material</b>                            |   |                 |            |            |           |              |
| 9   | N BUNA-N (NBR) max. 212 °F                                    | N/C             |            |            |           |              |
|   | V Viton® (FPM) max. 400 °F                                    | N/C             |            |            |           |              |
|   | P Teflon® (PTFE) max. 500 °F                                  | \$18.75         |            |            |           |              |
|   | ? Other - please specify                                      | on inquiry      |            |            |           |              |
| 10  | <b>Fastening parts material (retainer flange &amp; bolts)</b> |                 |            |            |           |              |
|   | G Galvanized steel  | N/C             |            |            |           |              |
|   | P Stainless steel   | \$104.95        |            |            |           |              |
|   | ? Other - please specify                                      | on inquiry      |            |            |           |              |
|   | <b>Flushing connection</b>                                    |                 | <b>C2</b>  | <b>M1</b>  | <b>H2</b> | <b>other</b> |
|   | 1 Without   | N/C             |            |            |           |              |
| 2 1 x ⅛" NPT female                               | 79.60   | 120.05          | 161.20     | on inquiry |           |              |
| 3 1 x ¼" NPT female                               | 79.60   | 120.05          | 161.20     | on inquiry |           |              |
| 4 2 x ⅛" NPT female                               | 157.65  | 240.15          | 336.35     | on inquiry |           |              |
| 5 2 x ¼" NPT female                               | 157.65  | 240.15          | 336.35     | on inquiry |           |              |
| ? Other - please specify                          | on inquiry  |                 |            |            |           |              |

<sup>1</sup> RFSF sealing face required for lined/coated lower housings

<sup>2</sup> No Flushing ports available



DIAPHRAGM SEALS

Order Code: 1 2 3 4 5 6 7 8 9 10

990.FA -

**ZZZ ZZZ**

\*Additional order details \_\_\_\_\_  
(see Page 229)

# FLANGED SEALS

Diaphragm Seals > Flanged Seals > 990.FC

DIAPHRAGM SEALS

| 990.FC Smart Code Configuration |  |   |                               |            |
|---------------------------------|--|---|-------------------------------|------------|
| Field no.                       | Code                                   | List price                                    |                               |            |
| 1                               | <b>Process connection type</b>         |   |                               |            |
|                                 | A                                      | ASME B16.5                                    | N/C                           |            |
|                                 | ?                                      | Other - please specify                        | on inquiry                    |            |
| 2                               | <b>Process connection DIN</b>          |   |                               |            |
|                                 | SM10                                   | 1"  | \$117.75                      |            |
|                                 | SM15                                   | 1½"   | \$160.50                      |            |
|                                 | ????                                   | Other - please specify                        | on inquiry                    |            |
| 3                               | <b>Nominal pressure rating DIN</b>     |   | <b>Multiplier for Field 2</b> |            |
|                                 | 1                                      | Class 150                                     | 1.00                          |            |
|                                 | 2                                      | Class 300                                     | 1.30                          |            |
|                                 | 4                                      | Class 600                                     | 1.60                          |            |
|                                 | ?                                      | Other - please specify                        | on inquiry                    |            |
| 4                               | <b>Sealing face</b>                    |   |                               |            |
|                                 | 1B                                     | RF 125 ... 250 RMS                            | \$151.70                      |            |
|                                 | 1F                                     | Ring (Type) Joint (RTJ / RJF)                 | \$185.90                      |            |
|                                 | SF                                     | Raised Face Smooth Finish (RFSF) <sup>1</sup> | \$151.70                      |            |
| ??                              | Other - please specify                 | on inquiry                                    |                               |            |
| 5                               | <b>Upper housing material</b>          |   |                               |            |
|                                 | CS                                     | Carbon steel 1018 nickel-plated               | N/C                           |            |
|                                 | C2                                     | 316L SS (1.4435)                              | \$95.90                       |            |
|                                 | T1                                     | Titanium grade 2 (3.7035)                     | \$753.60                      |            |
|                                 | ??                                     | Other - please specify                        | on inquiry                    |            |
|                                 | <b>Diaphragm material</b>              |   |                               |            |
| C2                              | 316L SS (1.4435)                       | N/C   |                               |            |
| H3                              | Hastelloy® B2 (2.4617)                 | \$40.40                                       |                               |            |
| H2                              | Hastelloy® C276 (2.4819)               | \$40.40                                       |                               |            |
| M1                              | Monel® 400 (2.4360)                    | \$24.10                                       |                               |            |
| I1                              | Inconel® 600 (2.4816 )                 | \$32.95                                       |                               |            |
| I2                              | Incoloy 825 (2.4858)                   | \$32.95                                       |                               |            |
| TL                              | Tantalum                               | \$97.45                                       |                               |            |
| NL                              | Nickel                                 | \$31.55                                       |                               |            |
| T1                              | Titanium grade 2 (3.7035) <sup>2</sup> | \$48.10                                       |                               |            |
| C0                              | Carpenter 20                           | \$32.95                                       |                               |            |
| CP                              | 316L SS with PTFE-foil                 | \$51.05                                       |                               |            |
| CF                              | 316L SS w/ PFA coating                 | \$33.10                                       |                               |            |
| CG                              | 316L SS w/ gold plating <sup>3</sup>   | on inquiry                                    |                               |            |
| ??                              | Other - please specify                 | on inquiry                                    |                               |            |
| 6                               | <b>Lower housing material</b>          |   |                               |            |
|                                 |  |   | <b>1"</b> <b>1½"</b>          |            |
|                                 | CS                                     | Carbon steel 1018 nickel-plated               | N/C                           | \$157.00   |
|                                 | C2                                     | SS 316L (1.4435)                              | \$176.60                      | \$185.40   |
|                                 | H3                                     | Hastelloy® B2 (2.4617)                        | on inquiry                    |            |
|                                 | H4                                     | Hastelloy® B3 (2.4600)                        | on inquiry                    |            |
|                                 | H2                                     | Hastelloy® C276 (2.4819)                      | \$726.20                      | \$1,412.00 |
|                                 | M1                                     | Monel® 400 (2.4360)                           | \$450.80                      | \$839.00   |
|                                 | I1                                     | Inconel® 600 (2.4816)                         | on inquiry                    |            |
|                                 | I2                                     | Incoloy 825 (2.4816)                          | on inquiry                    |            |
|                                 | TL                                     | Tantalum lining <sup>1,4</sup>                | \$1,365.00                    | \$2,167.00 |
|                                 | NL                                     | Nickel  | on inquiry                    |            |
|                                 | T1                                     | Titanium grade 2 (3.7035)                     | on inquiry                    |            |

| 990.FC Smart Code Configuration |  |   |            |           |           |              |
|---------------------------------|--|---|------------|-----------|-----------|--------------|
| Field no.                       | Code   | List price  |            |           |           |              |
| 7                               | C0   | Carpenter 20  | on inquiry |           |           |              |
|                                 | CW   | 316SS with virgin PTFE-lining <sup>1,4</sup>              | on inquiry |           |           |              |
|                                 | CF   | 316SS with PFA-coating <sup>1,4</sup>                     | on inquiry |           |           |              |
|                                 | ??   | Other - please specify                                    | on inquiry |           |           |              |
| 8                               | <b>Gasket material</b>                               |   |            |           |           |              |
|                                 | N  | BUNA-N (NBR) max. 212 °F                                  | N/C        |           |           |              |
|                                 | V  | Viton® (FPM) max. 400 °F                                  | N/C        |           |           |              |
|                                 | P  | Teflon® (PTFE) max. 500 °F                                | \$10.55    |           |           |              |
|                                 | C  | Metal form C (SS / silver) max. 752 °F <sup>5</sup>       | \$196.25   |           |           |              |
|                                 | G  | Metal form C (Inconel® / silver) max. 752 °F <sup>5</sup> | \$196.25   |           |           |              |
| ?                               | Other - please specify                               | on inquiry  |            |           |           |              |
| 9                               | <b>Fastening parts (retainer flange &amp; bolts)</b> |   |            |           |           |              |
|                                 | G  | Galvanized steel  | N/C        |           |           |              |
|                                 | P  | Stainless steel   | \$104.95   |           |           |              |
| ?                               | Other - please specify                               | on inquiry  |            |           |           |              |
| 10                              | <b>Flushing connection</b>                           |   | <b>C2</b>  | <b>M1</b> | <b>H2</b> | <b>other</b> |
|                                 | Z  | Without   | N/C        |           |           |              |
|                                 | 1  | 1 x ¼" NPT  | 79.60      | 120.05    | 161.20    | on inquiry   |
|                                 | 2  | 1 x ¼" NPT  | 79.60      | 120.05    | 161.20    | on inquiry   |
|                                 | 4  | 2 x ⅛" NPT  | 157.65     | 240.15    | 336.35    | on inquiry   |
|                                 | 5  | 2 x ¼" NPT  | 157.65     | 240.15    | 336.35    | on inquiry   |
|                                 | ?  | Other - please specify                                    | on inquiry |           |           |              |

- <sup>1</sup> RFSF sealing face required for lined / coated lower housings
- <sup>2</sup> Titanium diaphragm requires titanium upper housing
- <sup>3</sup> Gold plating 50 micro-inches
- <sup>4</sup> No Flushing ports available
- <sup>5</sup> For high temperature applications up to 752 °F



Order Code:    1       2       3       4       5       6       7       8       9       10

**990.FC -**           **ZZZ ZZZ**

\*Additional order details \_\_\_\_\_  
(see Page 229)

# FLANGED SEALS

Diaphragm Seals > Flanged Seals > 990.FD

| 990.FD Smart Code Configuration |                               |   |                               |            |
|---------------------------------|-------------------------------|---|-------------------------------|------------|
| Field no.                       | Code                          | List price                                    |                               |            |
| <b>Process connection type</b>  |                               |   |                               |            |
| 1                               | A                             | ASME B16.5                                    | N/C                           |            |
|                                 | ?                             | Other - please specify                        | on inquiry                    |            |
| <b>Process connection</b>       |                               |   |                               |            |
| 2                               | SM10                          | 1"  | \$117.75                      |            |
|                                 | SM15                          | 1½"   | \$160.50                      |            |
|                                 | ????                          | Other - please specify                        | on inquiry                    |            |
| <b>Nominal pressure rating</b>  |                               |   | <b>Multiplier for Field 2</b> |            |
| 3                               | 1                             | Class 150                                     | 1.00                          |            |
|                                 | 2                             | Class 300                                     | 1.30                          |            |
|                                 | ?                             | Other - please specify                        | on inquiry                    |            |
| <b>Sealing face</b>             |                               |   |                               |            |
| 4                               | 1B                            | Raised Face (RF) 125 ... 250 RMS              | \$151.70                      |            |
|                                 | 1F                            | Ring (Type) Joint (RTJ / RJF)                 | \$185.90                      |            |
|                                 | SF                            | Raised Face Smooth Finish (RFSF) <sup>1</sup> | \$151.70                      |            |
|                                 | ??                            | Other - please specify                        | on inquiry                    |            |
| <b>Upper housing material</b>   |                               |   |                               |            |
| 5                               | CS                            | Carbon steel 1018 nickel-plated               | N/C                           |            |
|                                 | C2                            | 316L SS (1.4435)                              | \$95.90                       |            |
|                                 | ??                            | Other - please specify                        | on inquiry                    |            |
| <b>Diaphragm material</b>       |                               |   |                               |            |
| 6                               | C2                            | 316L SS (1.4435)                              | N/C                           |            |
|                                 | H3                            | Hastelloy® B2 (2.4617)                        | \$40.40                       |            |
|                                 | H2                            | Hastelloy® C276 (2.4819)                      | \$40.40                       |            |
|                                 | M1                            | Monel® 400 (2.4360)                           | \$24.10                       |            |
|                                 | I1                            | Inconel® 600 (2.4816)                         | \$32.95                       |            |
|                                 | I2                            | Incoloy 825 (2.4858)                          | \$32.95                       |            |
|                                 | TL                            | Tantalum                                      | \$97.45                       |            |
|                                 | NL                            | Nickel 200                                    | \$31.55                       |            |
|                                 | T1                            | Titanium grade 2 (3.7035)                     | \$48.10                       |            |
|                                 | C0                            | Carpenter 20                                  | \$32.95                       |            |
|                                 | V1                            | Viton® (FPM) max 400 °F                       | \$29.30                       |            |
|                                 | CP                            | 316 SS with virgin PTFE-lining                | \$51.05                       |            |
|                                 | CF                            | 316 SS with PFA-coating                       | \$33.10                       |            |
|                                 | ??                            | Other - please specify                        | on inquiry                    |            |
|                                 | <b>Lower housing material</b> |   | <b>1"</b>                     | <b>1½"</b> |
|                                 | CS                            | Carbon steel 1018 nickel-plated               | N/C                           | \$151.05   |
|                                 | C2                            | 316L SS (1.4435)                              | \$176.60                      | \$185.40   |
| H3                              | Hastelloy® B2 (2.4617)        | on inquiry                                    |                               |            |
| H4                              | Hastelloy® B3 (2.4600)        | on inquiry                                    |                               |            |
| H2                              | Hastelloy® C276 (2.4819)      | \$726.00                                      | 1,351.00                      |            |
| M1                              | Monel® 400 (2.4360)           | \$451.00                                      | \$839.00                      |            |
| I1                              | Inconel® 600 (2.4816)         | on inquiry                                    |                               |            |
| I2                              | Incoloy 825 (2.4858)          | on inquiry                                    |                               |            |
| TL                              | Tantalum lining <sup>1</sup>  | on inquiry                                    |                               |            |
| NL                              | Nickel                        | on inquiry                                    |                               |            |
| T1                              | Titanium grade 2 (3.7035)     | on inquiry                                    |                               |            |

| 990.FD Smart Code Configuration                      |      |   |                                 |
|--|------|---|---------------------------------|
| Field no.  | Code | List price                                    |                                 |
| 7  | C0   | Carpenter 20                                  | on inquiry                      |
|  | CW   | 316 SS with virgin PTFE-lining <sup>1,2</sup> | on inquiry                      |
|  | CF   | 316 SS with PFA-coating <sup>1,2</sup>        | on inquiry                      |
|  | ??   | Other - please specify                        | on inquiry                      |
| <b>Gasket material</b>                               |      |   |                                 |
| 8  | N    | BUNA-N (NBR) max. 212 °F                      | N/C                             |
|  | V    | Viton® (FPM) max. 400 °F                      | N/C                             |
|  | P    | Teflon® (PTFE) max. 500 °F                    | \$18.25                         |
|  | ?    | Other - please specify                        | on inquiry                      |
| <b>Fastening parts (retainer flange &amp; bolts)</b> |      |   |                                 |
| 9  | G    | Galvanized steel                              | N/C                             |
|  | P    | Stainless steel                               | \$104.95                        |
|  | ?    | Other - please specify                        | N/C                             |
| <b>Flushing connection</b>                           |      |   |                                 |
| 10   | Z    | Without                                       | N/C                             |
|  | 1    | 1 x 1/8" NPT                                  | 79.60 120.05 161.20 on inquiry  |
|  | 2    | 1 x 1/4" NPT                                  | 79.60 120.05 161.20 on inquiry  |
|  | 4    | 2 x 1/8" NPT                                  | 157.65 240.15 336.35 on inquiry |
|  | 5    | 2 x 1/4" NPT                                  | 157.65 240.15 336.35 on inquiry |
|  | ?    | Other - please specify                        | on inquiry                      |

<sup>1</sup> RFSF sealing face required for lined / coated lower housings  
<sup>2</sup> No Flushing ports available



DIAPHRAGM SEALS

Order Code:      1      2      3      4      5      6      7      8      9      10

**990.FD -**           **ZZZ ZZZ**

\*Additional order details \_\_\_\_\_  
 (see Page 229)

# FLANGED SEALS

Diaphragm Seals > Flanged Seals > 990.FB

DIAPHRAGM SEALS

| 990.FB Smart Code Configuration |                                |  |                               |            |
|---------------------------------|--------------------------------|--|-------------------------------|------------|
| Field no.                       | Code                           | List price                             |                               |            |
| 1                               | <b>Process connection type</b> |  |                               |            |
|                                 | A                              | ASME B16.5                             | N/C                           |            |
|                                 | ?                              | Other - please specify                 | on inquiry                    |            |
|                                 | <b>Process connection</b>      |  |                               |            |
|                                 | SM05                           | ½"                                     | \$119.30                      |            |
|                                 | SM07                           | ¾"                                     | \$119.30                      |            |
|                                 | SM10                           | 1"                                     | \$142.05                      |            |
| 2                               | SM15                           | 1½"                                    | \$193.10                      |            |
|                                 | SM20                           | 2"                                     | \$336.55                      |            |
|                                 | ????                           | Other - please specify                 | on inquiry                    |            |
|                                 | <b>Nominal pressure rating</b> |  | <b>Multiplier for Field 2</b> |            |
|                                 | 1                              | Class 150                              | 1.00                          |            |
| 3                               | 2                              | Class 300                              | 1.30                          |            |
|                                 | 4                              | Class 600                              | 1.60                          |            |
|                                 | 5                              | Class 900                              | 2.30                          |            |
|                                 | 6                              | Class 1500                             | 2.80                          |            |
|                                 | ?                              | Other - please specify                 | on inquiry                    |            |
|                                 | <b>Sealing face style</b>      |  |                               |            |
| 4                               | 1B                             | Raised Face (RF) 125 ... 250 RMS       | \$151.75                      |            |
|                                 | 1F                             | Ring (Type) Joint (RTJ / RJF)          | \$185.90                      |            |
|                                 | ??                             | Other - please specify                 | on inquiry                    |            |
| <b>Upper housing material</b>   |                                |  |                               |            |
| 5                               | C2                             | 316L SS (1.4435)                       | \$183.55                      |            |
|                                 | T1                             | Titanium grade 2 (3.7035) <sup>1</sup> | \$684.85                      |            |
|                                 | ??                             | Other - please specify                 | on inquiry                    |            |
| <b>Diaphragm material</b>       |                                |  |                               |            |
| 6                               | C2                             | 316L SS (1.4435)                       | N/C                           |            |
|                                 | H3                             | Hastelloy® B2 (2.4617)                 | \$40.40                       |            |
|                                 | H4                             | Hastelloy® B3 (2.4600)                 | \$40.40                       |            |
|                                 | H2                             | Hastelloy® C276 (2.4819)               | \$40.40                       |            |
|                                 | M1                             | Monel® 400 (2.4360)                    | \$24.10                       |            |
|                                 | I1                             | Inconel® 600 (2.4816)                  | \$32.95                       |            |
|                                 | I2                             | Incoloy 825 (2.4858)                   | \$32.95                       |            |
|                                 | NL                             | Nickel                                 | \$31.55                       |            |
|                                 | T1                             | Titanium grade 2 (3.7035) <sup>1</sup> | \$48.15                       |            |
|                                 | C0                             | Carpenter 20                           | \$32.95                       |            |
|                                 | ??                             | Other - please specify                 | on inquiry                    |            |
|                                 | <b>Lower housing material</b>  |  | <b>1"</b>                     | <b>1½"</b> |
|                                 | C2                             | 316L SS (1.4435)                       | 265.95                        | 277.15     |
| H3                              | Hastelloy® B2 (2.46017)        | on inquiry                             |                               |            |
| H4                              | Hastelloy® B3 (2.4600)         | on inquiry                             |                               |            |
| H2                              | Hastelloy® C276 (2.4819)       | 2,567.00                               | 4,463.00                      |            |
| M1                              | Monel® 400 (2.4360)            | on inquiry                             |                               |            |
| I1                              | Inconel® 600 (2.4816)          | on inquiry                             |                               |            |
| I2                              | Incoloy 825 (2.4858)           | on inquiry                             |                               |            |
| NL                              | Nickel                         | on inquiry                             |                               |            |
| T1                              | Titanium grade 2 (3.7035)      | on inquiry                             |                               |            |
| C0                              | Carpenter 20                   | on inquiry                             |                               |            |
| 7                               | ??                             | Other - please specify                 | on inquiry                    |            |

| 990.FB Smart Code Configuration |                            |                        |            |           |           |              |
|---------------------------------|----------------------------|------------------------|------------|-----------|-----------|--------------|
| Field no.                       | Code                       | List Price             |            |           |           |              |
| 8                               | <b>Flushing connection</b> |                        | <b>C2</b>  | <b>M1</b> | <b>H2</b> | <b>other</b> |
|                                 | Z                          | Without                | N/C        |           |           |              |
|                                 | 1                          | 1 x ½" NPT female      | 79.60      | 120.05    | 161.20    | on inquiry   |
|                                 | 2                          | 1 x ¼" NPT female      | 79.60      | 120.05    | 161.20    | on inquiry   |
|                                 | 4                          | 2 x ½" NPT female      | 157.65     | 240.15    | 336.35    | on inquiry   |
|                                 | 5                          | 2 x ¼" NPT female      | 157.65     | 240.15    | 336.35    | on inquiry   |
| 8                               | ?                          | Other - please specify | on inquiry |           |           |              |

<sup>1</sup> All titanium design, only threaded instrument connections available



Order Code:      1      2      3      4      5      6      7      8

**990.FB -**         **ZZZ ZZZ**

\*Additional order details \_\_\_\_\_  
(see Page 229)

# FLANGED SEALS

Diaphragm Seals > Flanged Seals > 990.26

| 990.26 Smart Code Configuration |   |   |
|---------------------------------|---|---|
| Field no.                       | Code  | List price                                    |
| 1                               | <b>Process connection type</b>              |   |
|                                 | A   | ASME B16.5                                    |
|                                 | ?   | Other - please specify                        |
| 2                               | <b>Process connection</b>                   |   |
|                                 | SM05  | 1/2"  |
|                                 | SM07  | 3/4"  |
|                                 | SM10  | 1"  |
|                                 | ????  | Other - please specify                        |
| 3                               | <b>Nominal pressure rating</b>              |   |
|                                 | 1   | Class 150                                     |
|                                 | 2   | Class 300                                     |
|                                 | ?   | Other - please specify                        |
| 4                               | <b>Sealing face style</b>                   |   |
|                                 | 1B  | Raised face (RF) 125 ... 250 RMS              |
|                                 | 2B  | Raised face (RF) 64 ... 125 RMS               |
|                                 | 1F  | Ring (Type) Joint (RTJ / RJF)                 |
|                                 | SF  | Raised Face Smooth Finish (RFSF) <sup>1</sup> |
| ??                              | Other - please specify                      |   |
| 5                               | <b>Flange body material</b>                 |   |
|                                 | C2  | 316L SS (1.4435)                              |
|                                 | T1  | Titanium grade 2 (3.7035) <sup>2</sup>        |
|                                 | ??  | Other - please specify                        |
| 6                               | <b>Diaphragm and lower housing material</b> |   |
|                                 | C2-C2                                       | 316L SS (1.4435)                              |
|                                 | H3-H3                                       | Hastelloy® B2 / B3 (2.4617 / 2.4600)          |
|                                 | H4-H4                                       | Hastelloy® C4 (2.4610)                        |
|                                 | H2-H2                                       | Hastelloy® C276 (2.4819)                      |
|                                 | M1-M1                                       | Monel® 400 (2.4360)                           |
|                                 | I1-I1                                       | Inconel® 600 (2.4816 )                        |
|                                 | I2-I2                                       | Incoloy 825 (2.4858)                          |
|                                 | TL-TL                                       | Tantalum <sup>1</sup>                         |
|                                 | NL-NL                                       | Nickel  |
|                                 | T1-T1                                       | Titanium grade 2 (3.7035) <sup>2</sup>        |
|                                 | C0-C0                                       | Carpenter 20                                  |
|                                 | CW-CW                                       | 316L SS with virgin PTFE-lining <sup>1</sup>  |
|                                 | ??-??                                       | Other - please specify                        |



DIAPHRAGM SEALS

<sup>1</sup> RFSF sealing face required for lined / coated lower housings  
<sup>2</sup> All titanium design, only threaded instrument connections available

Order Code:      1      2      3      4      5      6

**990.26** -       -  **Z ZZZ**

\*Additional order details \_\_\_\_\_  
 (see Page 229)

# FLANGED SEALS

Diaphragm Seals > Flanged Seals > 990.27

## 990.27 Smart Code Configuration

| Field no.                                  | Code                   | List price                                     |
|--|------------------------|--|
| <b>Process connection type</b>             |                        |  |
| 1  | A                      | ASME B16.5                                     |
|  | ?                      | Other - please specify                         |
| <b>Process connection</b>                  |                        |  |
| 2  | SM15                   | 1½"  |
|  | SM20                   | 2"   |
|  | SM30                   | 3"   |
|  | SM40                   | 4"   |
|  | SM50                   | 5"   |
|  | ??                     | Other - please specify                         |
| <b>Nominal pressure rating</b>             |                        | <b>Multiplier for Field 2</b>                  |
| 3  | 1                      | Class 150                                      |
|  | 2                      | Class 300                                      |
|  | 4                      | Class 600                                      |
|  | 5                      | Class 900                                      |
|  | 6                      | Class 1500                                     |
|  | ?                      | Other - please specify                         |
| <b>Sealing face style</b>                  |                        |  |
| 4  | 1B                     | Raised Face (RF) 125 ... 250 RMS               |
|  | 2B                     | Raised Face (RF) 64 ... 125 RMS                |
|  | 1F                     | Ring (Type) Joint (RTJ / RJF)                  |
|  | SF                     | Raised Face Smooth Finish (RFSF) <sup>1</sup>  |
|  | ??                     | Other - please specify                         |
| <b>Flange body material</b>                |                        |  |
| 5  | C2                     | 316L SS (1.4435)                               |
|  | T1                     | Titanium grade 2 (3.7035) <sup>2</sup>         |
|  | ??                     | Other - please specify                         |
| <b>Sealing face and Diaphragm material</b> |                        |  |
| 6  | C2-C2                  | 316L SS (1.4435)                               |
|  | H3-H3                  | Hastelloy® B2 (2.4617) <sup>1</sup>            |
|  | H4-H4                  | Hastelloy® B3 (2.4600) <sup>1</sup>            |
|  | H2-H2                  | Hastelloy® C276 (2.4819) <sup>1</sup>          |
|  | M1-M1                  | Monel® 400 (2.4360) <sup>1</sup>               |
|  | I1-I1                  | Inconel® 600 (2.4816) <sup>1</sup>             |
|  | I2-I2                  | Incoloy 825 (2.4858) <sup>1</sup>              |
|  | TL-TL                  | Tantalum <sup>1</sup>                          |
|  | NL-NL                  | Nickel <sup>1</sup>                            |
|  | T1-T1                  | Titanium grade 2 (3.7035) <sup>1,2</sup>       |
|  | CW-CW                  | 316L SS with virgin PTFE-lining <sup>1,3</sup> |
|  | CP-CP                  | 316L SS with black PFA-lining <sup>1,3</sup>   |
|  | CF-CF                  | 316L SS with PFA-coating <sup>1,3</sup>        |
|  | CG-CG                  | 316L SS with gold-plating <sup>1,4</sup>       |
| ??-??                                      | Other - please specify |  |



DIAPHRAGM SEALS

<sup>1</sup> RFSF sealing face required for lined / coated lower housings

<sup>2</sup> 316L SS flange body available for titanium sealing face and diaphragm (max. temp 300 °F). All titanium design required for higher temperature applications

<sup>3</sup> For polymer lined/coated 316L SS, virgin PTFE (max. temp 300 °F), black PTFE (temp 500 °F), PFA (max. temp 500 °F)

<sup>4</sup> Gold plated 50 micro-inches

Order Code:      1      2      3      4      5      6

**990.27** -       -  **ZZZ**

\*Additional order details \_\_\_\_\_  
(see Page 229)



# FLANGED SEALS

Diaphragm Seals > Flanged Seals > 990.FR

| 990.FR Smart Code Configuration |  |   |
|---------------------------------|--|---|
| Field no.                       | Code                                       | List price                                    |
| 1                               | <b>Process connection type</b>             |   |
|                                 | A  | ASME B16.5                                    |
|                                 | ?  | Other - please specify                        |
| 2                               | <b>Process connection</b>                  |   |
|                                 | SM20                                       | 2"  |
|                                 | SM30                                       | 3"  |
|                                 | SM40                                       | 4"  |
|                                 | SM50                                       | 5"  |
|                                 | ??   | Other - please specify                        |
| 3                               | <b>Nominal pressure rating</b>             |   |
|                                 | <b>Multiplier for Field 2</b>              |   |
|                                 | 1  | Class 150                                     |
|                                 | 2  | Class 300                                     |
|                                 | 4  | Class 600                                     |
|                                 | 5  | Class 900                                     |
|                                 | 6  | Class 1500                                    |
| ?                               | Other - please specify                     |   |
| 4                               | <b>Sealing face style</b>                  |   |
|                                 | 1B   | Raised Face (RF) 125 ... 250 RMS              |
|                                 | 1F   | Ring (Type) Joint (RTJ / RJF)                 |
|                                 | SF   | Raised Face Smooth Finish (RFSF) <sup>1</sup> |
|                                 | ??   | Other - please specify                        |
| 5                               | <b>Flange body material</b>                |   |
|                                 | C2   | 316L SS (1.4435)                              |
|                                 | <b>Sealing face and Diaphragm material</b> |   |
|                                 | C2-C2                                      | 316L SS (1.4435)                              |
|                                 | H3-H3                                      | Hastelloy® B2 (2.4617)                        |
|                                 | H4-H4                                      | Hastelloy® B3 (2.4600)                        |
|                                 | H2-H2                                      | Hastelloy® C276 (2.4819)                      |
|                                 | M1-M1                                      | Monel® 400 (2.4360)                           |
|                                 | I1-I1                                      | Inconel® 600 (2.4816 )                        |
|                                 | I2-I2                                      | Incoloy 825 (2.4858)                          |
|                                 | NL-NL                                      | Nickel <sup>1</sup>                           |
|                                 | T1-T1                                      | Titanium grade 2 (3.7035)                     |
|                                 | CF-CF                                      | 316L SS with PFA-coating <sup>1</sup>         |
|                                 | CG-CG                                      | 316L SS with gold-plating <sup>1,2</sup>      |
|                                 | ??-??                                      | Other - please specify                        |
| 6                               |  |   |



DIAPHRAGM SEALS

<sup>1</sup> RFSF sealing face required for lined / coated lower housings

<sup>2</sup> Gold plated 50 micro-inches

Order Code:      1          2          3          4          5          6

**990.FR** -       -  **ZZZ**

\*Additional order details \_\_\_\_\_  
(see Page 229)

# FLANGED SEALS

Diaphragm Seals > Flanged Seals > 990.28

| 990.28 Smart Code Configuration |   |   |                     |
|---------------------------------|---|---|---------------------|
| Field no.                       | Code  |   | List price          |
| 1                               | <b>Process connection type</b>                          |   |                     |
|                                 | A   | ASME B16.5                                    | N/C                 |
|                                 | ?   | Other - please specify                        | on inquiry          |
| 2                               | <b>Process connection</b>                               |   |                     |
|                                 | SM15Z   | 1½"   | \$649.55            |
|                                 | SM20Z   | 2"  | \$649.55            |
|                                 | SM30Z   | 3"  | \$684.25            |
|                                 | SM40Z   | 4"  | \$890.80            |
|                                 | SM50Z   | 5"  | on inquiry          |
| 2                               | ?????   | Other - please specify                        | on inquiry          |
| 3                               | <b>Sealing face style</b>                               |   |                     |
|                                 | 1B  | Raised Face (RF) 125 ... 250 RMS              | N/C                 |
|                                 | 2B  | Raised Face (RF) 64 ... 125 RMS               | \$58.10             |
|                                 | 1F  | Ring (Type) Joint (RTJ / RJF) <sup>1</sup>    | \$69.20             |
|                                 | SF  | Raised Face Smooth Finish (RFSF) <sup>2</sup> | \$58.10             |
| 3                               | ??  | Other - please specify                        | on inquiry          |
| 4                               | <b>Flange body material</b>                             |   |                     |
|                                 | C2  | 316L SS (1.4435)                              | N/C                 |
| 4                               | ??  | Other - please specify                        | on inquiry          |
| 5                               | <b>Sealing face and Diaphragm material</b> <sup>3</sup> |   | Up to 4"   5"       |
|                                 | C2-C2   | 316L SS (1.4435)                              | N/C                 |
|                                 | H3-H3   | Hastelloy® B2 (2.4617) <sup>2</sup>           | on inquiry          |
|                                 | H4-H4   | Hastelloy® B3 (2.4600) <sup>2</sup>           | on inquiry          |
|                                 | H2-H2   | Hastelloy® C276 (2.4819) <sup>2</sup>         | \$241.15 on inquiry |
|                                 | M1-M1   | Monel® 400 (2.4360) <sup>2</sup>              | \$175.80 on inquiry |
|                                 | I1-I1   | Inconel® 600 (2.4816) <sup>2</sup>            | on inquiry          |
|                                 | I2-I2   | Incoloy 825 (2.4858) <sup>2</sup>             | on inquiry          |
|                                 | TL-TL   | Tantalum <sup>2</sup>                         | \$347.50 on inquiry |
|                                 | NL-NL   | Nickel <sup>2</sup>                           | on inquiry          |
|                                 | T1-T1   | Titanium grade 2 (3.7035) <sup>2</sup>        | on inquiry          |
|                                 | CW-CW   | 316L SS with virgin PFA-lining <sup>2,4</sup> | \$515.30 on inquiry |
|                                 | CP-CP   | 316L SS with black PFA-lining <sup>2,4</sup>  | on inquiry          |
|                                 | CF-CF   | 316L SS with PFA-coating <sup>2,4</sup>       | on inquiry          |
|                                 | CG-CG   | 316L SS with gold-plating <sup>2,3</sup>      | on inquiry          |
| C0-C0                           | Carpenter 20 <sup>2</sup>                               | on inquiry                                    |                     |
| 5                               | ??-??   | Other - please specify                        | on inquiry          |



990.28 (see chart on left)



990.41 (see charts on right)

DIAPHRAGM SEALS

<sup>1</sup> For RTJ / RJF faces, please provide the flange pressure class for the diaphragm seal connection site  
<sup>2</sup> RFSF sealing face required for for all materials except for 316L SS  
<sup>3</sup> All material offered except for 316L SS are bonded to the flange body material  
<sup>4</sup> For polymer lined/coated 316L SS, virgin PTFE (max. temp 300 °F), black PTFE (temp 500 °F), PFA (max. temp 500 °F)  
<sup>5</sup> Gold plated 50 micro-inches

Order Code:    1    2    3    4    5

**990.28** -      -  **ZZZ**

\*Additional order details \_\_\_\_\_  
 (see Page 229)



# SANITARY SEALS

Diaphragm Seals > Sanitary Seals > 990.22

| 990.22 Smart Code Configuration              |                          |                                      |            |
|--|--------------------------|--------------------------------------|------------|
| Field no.                                    | Code                     | List price                           |            |
| <b>Process connection</b>                    |                          |                                      |            |
| 1  | TB115                    | 1½" Tri-Clamp®                       | \$268.90   |
|  | TB120                    | 2" Tri-Clamp®                        | \$268.90   |
|  | TB125                    | 2½" Tri-Clamp®                       | \$369.25   |
|  | TB130                    | 3" Tri-Clamp®                        | \$394.90   |
|  | TB140                    | 4" Tri-Clamp®                        | \$428.75   |
|  | ????                     | Other - please specify               | on inquiry |
| <b>Housing and Diaphragm material</b>        |                          |                                      |            |
| 2  | C2-C2                    | 316L SS (1.4435)                     | N/C        |
|  | CT-CT                    | 316L SS (1.4435) electropolished     | \$36.95    |
|  | H2-H2                    | Hastelloy® C276 (2.4819)             | on inquiry |
|  | ??-??                    | Other - please specify               | on inquiry |
|  | <b>Surface roughness</b> |                                      |            |
| 3  | A                        | Ra ≤ 30 micro-inches                 | N/C        |
| <b>Gasket material</b>                       |                          |                                      |            |
| 4  | Z                        | Without                              | N/C        |
| <b>Clamp diameter for process connection</b> |                          |                                      |            |
| 5  | 025                      | 0.98" (25 mm) - ¾" Tri-Clamp®        | N/C        |
|  | 505                      | 1.99" (50.5 mm) - 1", 1½" Tri-Clamp® | N/C        |
|  | 064                      | 2.50" (64 mm) - 2" Tri-Clamp®        | N/C        |
|  | 775                      | 3.10" (77.5 mm) - 2½" Tri-Clamp®     | N/C        |
|  | 091                      | 3.58" (91 mm) - 3" Tri-Clamp®        | N/C        |
|  | 119                      | 4.70" (119 mm) - 4" Tri-Clamp®       | N/C        |



DIAPHRAGM SEALS

Order Code:                    1                    2                    3                    4                    5

**990.22 -**                   

\*Additional order details \_\_\_\_\_  
(see Page 229)

# PLASTIC SEALS

Diaphragm Seals > Plastic Seals > 990.31

| 990.31 Smart Code Configuration <sup>1</sup> |  |            |
|--|--|------------|
| Field no.                                    | Code   | List price |
| <b>Process connection</b>                    |  |            |
| 1  | P4F ¼" NPT female                                    | \$173.25   |
|  | P2F ½" NPT female                                    | \$198.75   |
| <b>Upper housing material</b>                |  |            |
| 2  | PP PP (polypropylene) blue, RAL 5022                 | N/C        |
| <b>Diaphragm material</b>                    |  |            |
| 3  | PT CSM, with PTFE foil on the medium side            | N/C        |
| <b>Lower housing material</b>                |  |            |
| 4  | PC Polyvinyl chloride (PVC) grey, RAL 7011           | N/C        |
|  | PP Polypropylene (PP) grey, RL 7032                  | \$19.00    |
|  | PD Polyvinylidene flouride (PVDF), translucent white | \$111.50   |
|  | ?? Other - please specify                            | on inquiry |



<sup>1</sup> Material (MTR) certificate per EN 10201 3.1 is not available

Order Code:            1            2            3            4

**990.31** -     **ZZZ**

\*Additional order details \_\_\_\_\_  
(see Page 229)

DIAPHRAGM SEALS

# InLine SEALS

Diaphragm Seals > InLine Seals > 981.10

## 981.10 Smart Code Configuration

| Field no.                                       | Code                   | List price                                    |
|---|------------------------|---|
| <b>Process connection type</b>                  |                        |   |
| 1   | A                      | ASME B16.5                                    |
|   | ?                      | Other - please specify                        |
| <b>Process conn. (nominal size)</b>             |                        | <b>Add. price</b>                             |
| 1   | SM10                   | 1"  |
|   | SM15                   | 1½"   |
|   | SM20                   | 2"  |
|   | SM30                   | 3"  |
|   | SM40                   | 4"  |
| 2   | ????                   | Other - please specify                        |
| <b>Sealing face</b>                             |                        |   |
| 3   | 1B                     | Raised Face (RF) 125 ... 250 RMS              |
|   | 2B                     | Raised Face (RF) 64 ... 125 RMS               |
|   | 1F                     | Ring (Type) Joint (RTJ / RJF) <sup>1</sup>    |
|   | SF                     | Raised Face Smooth Finish (RFSF) <sup>2</sup> |
|   | ??                     | Other - please specify                        |
| <b>Body material</b>                            |                        |   |
| 4   | C2                     | 316L SS (1.4435)                              |
|   | ??                     | Other - please specify                        |
| <b>Sealing face and Diaphragm material</b>      |                        |   |
| 5   | C2-C2                  | 316L SS (1.4435)                              |
|   | H3-H3                  | Hastelloy® B2 (2.4617) <sup>2</sup>           |
|   | H2-H2                  | Hastelloy® C276 (2.4819) <sup>2</sup>         |
|   | M1-M1                  | Monel® 400 (2.4360) <sup>2</sup>              |
|   | TI-TL                  | Tantalum <sup>2</sup>                         |
|   | T1-T1                  | Titanium grade 2(3.7035) <sup>2,3</sup>       |
|   | CF-CF                  | 316L SS with PFA-coating <sup>2,4</sup>       |
| ??  | Other - please specify |   |
| <b>Internal diameter for process connection</b> |                        |   |
| 6   | 0285                   | 1.122" (28.5 mm) - 1" process                 |
|   | 0430                   | 1.692" (43 mm) - 1½" process                  |
|   | 0545                   | 2.145" (54.5 mm) - 2" process                 |
|   | 0825                   | 3.248" (82.5 mm) - 3" process                 |
|   | 1070                   | 4.212" (107 mm) - 4" process                  |
|   | ????                   | Other - please specify                        |
| <b>Overall length</b>                           |                        |   |
| 7   | 060                    | 2.36" (60 mm) - standard                      |
|   | 100                    | 3.94" (100 mm)                                |
|   | ???                    | Other - please specify                        |
| <b>Zero point stabilization</b>                 |                        |   |
| 8   | Z                      | Without                                       |
|   | Y                      | With zero point stabilization                 |



DIAPHRAGM SEALS

<sup>1</sup> For RTJ / RJF faces, please provide the flange pressure class for the diaphragm seal connection site  
<sup>2</sup> RFSF sealing face required for for all materials except for 316L SS  
<sup>3</sup> 316L SS flange body available for titanium sealing face and diaphragm (max. temp 300 °F). All titanium design required for higher temperature applications  
<sup>4</sup> For polymer lined/coated 316L SS, virgin PTFE (max. temp 300 °F), black PTFE (temp 500 °F), PFA (max. temp 500 °F)

Order Code:    1        2        3        4        5        6        7        8

**981.10 -**         **ZZZ**

\*Additional order details \_\_\_\_\_  
 (see Page 229)

# InLine SEALS

Diaphragm Seals > InLine Seals > 981.22

| 981.22 Smart Code Configuration                 |       |   |            |
|---|-------|---|------------|
| Field no.                                       | Code  | List price                                    |            |
| <b>Process connection type</b>                  |       |   |            |
| 1   | TB107 | 3/4" Tri-Clamp®                               | \$1,168.00 |
|   | TB110 | 1" Tri-Clamp®                                 | \$1,137.00 |
|   | TB115 | 1½" Tri-Clamp®                                | \$1,267.00 |
|   | TB120 | 2" Tri-Clamp®                                 | \$1,487.00 |
|   | TB125 | 2½" Tri-Clamp®                                | \$1,569.00 |
|   | TB130 | 3" Tri-Clamp®                                 | \$1,794.00 |
|   | TB140 | 4" Tri-Clamp®                                 | \$2,326.00 |
| 1   | ????  | Other - please specify                        | on inquiry |
| <b>Body and diaphragm material</b>              |       |   |            |
| 2   | C2-C2 | 316L SS (1.4435) <sup>1</sup>                 | N/C        |
|   | CT-CT | 316L SS (1.4435) electropolished <sup>2</sup> | \$71.95    |
|   | H2-H2 | Hastelloy® C276( 2.4819) <sup>1</sup>         | on inquiry |
|   | ??-?? | Other - please specify                        | on inquiry |
| <b>Surface roughness</b>                        |       |   |            |
| 3   | A     | Ra ≤ 30 micro-inches <sup>1</sup>             | N/C        |
|   | B     | Ra ≤ 15 micro-inches <sup>2</sup>             | N/C        |
| <b>Gasket</b>                                   |       |   |            |
| 4   | Z     | Without                                       | N/C        |
| <b>Internal diameter for process connection</b> |       |   |            |
| 5   | 0157  | 0.618" (15.7 mm) - ¾" Tri-Clamp®              | N/C        |
|   | 0221  | 0.870" (22.1 mm) - 1" Tri-Clamp®              | N/C        |
|   | 0348  | 1.370" (34.8 mm) - 1½" Tri-Clamp®             | N/C        |
|   | 0475  | 1.870" (47.5 mm) - 2" Tri-Clamp®              | N/C        |
|   | 0602  | 2.370" (60.2 mm) - 2½" Tri-Clamp®             | N/C        |
|   | 0729  | 2.870" (72.9 mm) - 3" Tri-Clamp®              | N/C        |
|   | 0976  | 3.843" (97.6 mm) - 4" Tri-Clamp®              | N/C        |
|   | ????  | Other - please specify                        | on inquiry |
| <b>Overall length for process connection</b>    |       |   |            |
| 6   | 100   | 3.94" (100 mm) - ¾" Tri-Clamp®                | N/C        |
|   | 114   | 4.49" (114 mm) - 1" Tri-Clamp®                | N/C        |
|   | 146   | 5.75" (146 mm) - 1½" Tri-Clamp®               | N/C        |
|   | 156   | 6.14" (156 mm) - 2" & larger Tri-Clamp®       | N/C        |
|   | ???   | Other - please specify                        | on inquiry |
| <b>Clamp diameter for process connection</b>    |       |   |            |
| 7   | 025   | 0.98" (25 mm) - ¾" Tri-Clamp®                 | N/C        |
|   | 505   | 1.99" (50.5 mm) - 1", 1½" Tri-Clamp®          | N/C        |
|   | 064   | 2.50" (64 mm) - 2" Tri-Clamp®                 | N/C        |
|   | 775   | 3.10" (77.5 mm) - 2½" Tri-Clamp®              | N/C        |
|   | 091   | 3.58" (91 mm) - 3" Tri-Clamp®                 | N/C        |
|   | 119   | 4.70" (119 mm) - 4" Tri-Clamp®                | N/C        |
| <b>Zero point stabilization</b>                 |       |   |            |
| 8   | Z     | Without                                       | N/C        |
|   | Y     | With zero point stabilization                 | on inquiry |



DIAPHRAGM SEALS

<sup>1</sup> Surface roughness for 316L SS and Hastelloy® C276 is ≤ 30 micro-inches  
<sup>2</sup> Surface roughness for 316L SS electropolished is ≤ 15 micro-inches

Order Code:                    1                    2                    3 4                    5                    6                    7                    8

**981.22** - 

|  |  |  |  |  |  |  |  |
|--|--|--|--|--|--|--|--|
|  |  |  |  |  |  |  |  |
|--|--|--|--|--|--|--|--|

**ZZZ**

\*Additional order details \_\_\_\_\_  
 (see Page 229)

# InLine SEALS

Diaphragm Seals > InLine Seals > 981.27

DIAPHRAGM SEALS

| 981.27 Smart Code Configuration |  |                               |
|---------------------------------|--|-------------------------------|
| Field no.                       | Code   | List price                    |
| <b>Process connection type</b>  |  |                               |
| 1                               | A ASME B16.5                                     | \$2,239.00                    |
|                                 | ? Other - please specify                         | on inquiry                    |
| <b>Process connection</b>       |  | <b>Add. price</b>             |
|                                 | SM10 1"  | N/C                           |
|                                 | SM15 1½"   | \$173.80                      |
|                                 | SM20 2"  | \$326,10                      |
|                                 | SM30 3"  | \$565.95                      |
|                                 | SM40 4"  | \$1,026.85                    |
| 2                               | ???? Other - please specify                      | on inquiry                    |
| <b>Nominal pressure rating</b>  |  | <b>Multiplier for Field 2</b> |
|                                 | 1 Class 150                                      | 1.00                          |
|                                 | 2 Class 300                                      | 1.30                          |
|                                 | 4 Class 600                                      | 1.60                          |
| 3                               | ? Other - please specify                         | on inquiry                    |
| <b>Sealing face</b>             |  |                               |
|                                 | 1B Raised Face (RF) 125 ... 250 RMS              | N/C                           |
|                                 | 2B Raised Face (RF) 64 ... 125 RMS               | \$58.15                       |
|                                 | 1F Ring (Type) Joint (RTJ / RJF)                 | on inquiry                    |
|                                 | SF Raised Face Smooth Finish (RFSF) <sup>1</sup> | \$56.80                       |
| 4                               | ?? Other - please specify                        | on inquiry                    |
| <b>Flange body material</b>     |  |                               |
|                                 | C2 316L SS (1.4435)                              | N/C                           |
|                                 | T1 Titanium grade 2 (3.7035)                     | \$58.15                       |
| 5                               | ?? Other - please specify                        | on inquiry                    |
| <b>Material of wetted parts</b> |  |                               |
|                                 | C2-C2 316L SS (1.4435)                           | N/C                           |
|                                 | H3-H3 Hastelloy® B2 (2.4617)                     | on inquiry                    |
|                                 | H2-H2 Hastelloy® C276 (2.4819)                   | on inquiry                    |
|                                 | M1-M1 Monel® 400 (2.4360)                        | on inquiry                    |
|                                 | TL-TL Tantalum                                   | on inquiry                    |
|                                 | T1-T1 Titanium grade 2 (3.7035) <sup>2</sup>     | on inquiry                    |
|                                 | CF-CF 316L SS with PFA-coating <sup>1,3</sup>    | on inquiry                    |
| 6                               | ???? Other - please specify                      | on inquiry                    |

| 981.27 Smart Code Configuration                 |                                     |            |
|---|-------------------------------------|------------|
| Field no.                                       | Code                                | List price |
| <b>Internal diameter for process connection</b> |                                     |            |
|   | 0266 1.047" (26.6 mm) - 1" process  | N/C        |
|   | 0430 1.692" (43 mm) - 1½" process   | N/C        |
|   | 0525 2.067" (52.5 mm) - 2" process  | N/C        |
|   | 0780 3.070" (78 mm) - 3" process    | N/C        |
|   | 1023 4.027" (102.3 mm) - 4" process | N/C        |
| 7   | ???? Other - please specify         | on inquiry |
| <b>Overall length for process connection</b>    |                                     |            |
|   | 114 4.49" (114 mm) - 1" process     | N/C        |
|   | 146 5.75" (146 mm) - 1½" process    | N/C        |
|   | 156 6.14" (156 mm) - 2" process     | N/C        |
|   | 166 6.54" (166 mm) - 3", 4" process | N/C        |
| 8   | ???? Other - please specify process | on inquiry |

<sup>1</sup> RFSF sealing face required for all materials except for 316L SS

<sup>2</sup> 316L SS flange body available for titanium sealing face and diaphragm

(max. temp 300 °F). All titanium design required for higher temperature applications

<sup>3</sup> For polymer lined/coated 316L SS, PFA (max. temp 500 °F)

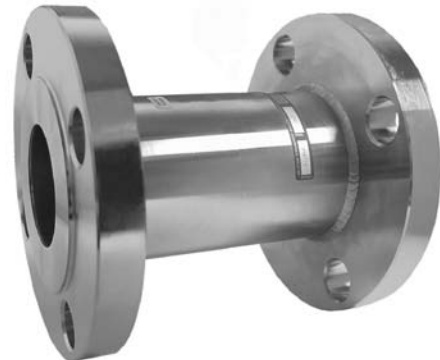

Order Code:      1            2            3            4            5            6            7            8

**981.27 -**         **ZZZ**

\*Additional order details \_\_\_\_\_  
(see Page 229)



# InLine SEALS

Diaphragm Seals > InLine Seals > 981.31

| 981.31 Smart Code Configuration <sup>1</sup> |                                       |                                  |                               |                   |
|--|---------------------------------------|----------------------------------|-------------------------------|-------------------|
| Field no.                                    | Code                                  |                                  | List price                    |                   |
| 1  | A                                     | <b>Process connection type</b>   |                               |                   |
|  |                                       | ASME B16.5                       | \$1,053.00                    |                   |
|  | SM20                                  | <b>Process connection</b>        |                               | <b>Add. price</b> |
|  |                                       | 2"                               |                               | N/C               |
|  |                                       | 3"                               |                               | \$167.10          |
|  |                                       | 4"                               |                               | \$332.90          |
|  |                                       | 5"                               |                               | \$505.25          |
| SM60   | 6"                                    |                                  | \$653.75                      |                   |
| 2  | ????                                  | Other - please specify           | on inquiry                    |                   |
| 3  | <b>Nominal pressure rating</b>        |                                  | <b>Multiplier for Field 2</b> |                   |
|  | 1                                     | Class 150                        | 1.00                          |                   |
|  | 2                                     | Class 300                        | 1.30                          |                   |
|  | ?                                     | Other - please specify           | on inquiry                    |                   |
| 4  | <b>Sealing face</b>                   |                                  |                               |                   |
|  | SF                                    | Raised Face Smooth Finish (RFSF) | N/C                           |                   |
|  | ??                                    | Other - please specify           | on inquiry                    |                   |
| 5  | <b>Body and sealing face material</b> |                                  |                               |                   |
|  | CB-CB                                 | Carbon steel, painted black      | N/C                           |                   |
|  | C2-C2                                 | 316 SS (1.4435)                  | on inquiry                    |                   |
|  | ??-??                                 | Other - please specify           | on inquiry                    |                   |
| 6  | <b>Diaphragm material</b>             |                                  |                               |                   |
|  | PU                                    | Polyurethane                     | N/C                           |                   |
|  | ??                                    | Other - please specify           | on inquiry                    |                   |



DIAPHRAGM SEALS

<sup>1</sup> Material (MTR) certificate per EN 10201 3.1 is not available

Order Code:      1      2      3      4      5      6

**981.31 -**

\*Additional order details \_\_\_\_\_  
(see Page 229)

# SEAL ACCESSORIES

Diaphragm Seals > Seal Accessories > 910.27

| 910.27 Smart Code Configuration |   |  |
|---------------------------------|---|--|
| Field no.                       | Code  | List price                                 |
| 1                               | <b>Process connection type</b>              |  |
|                                 | A   | ASME B16.5                                 |
|                                 | <b>Process connection</b>                   |  |
|                                 | SM15  | 1½"  |
|                                 | SM20  | 2"   |
|                                 | SM30  | 3"   |
| 2                               | SM40  | 4"   |
|                                 | ??  | Other - please specify                     |
| 3                               | <b>Nominal pressure rating <sup>1</sup></b> |  |
|                                 | <b>Multiplier for Field 2</b>               |  |
|                                 | z   | Class 150 ... 2,500 <sup>2,3</sup>         |
|                                 | 1   | Class150 (flange design)                   |
|                                 | 2   | Class 300 (flange design)                  |
|                                 | 4   | Class 600 (flange design)                  |
| 4                               | 6   | Class1500 (flange design)                  |
|                                 | <b>Sealing face</b>                         |  |
|                                 | 1B  | Raised Face (RF) 125 ... 250 RMS           |
|                                 | 2B  | Raised Face (RF) 64 ... 125 RMS            |
|                                 | 1F  | Ring (Type) Joint (RTJ / RJF) <sup>3</sup> |
| 5                               | SF  | Raised Face Smooth Finish (RFSF)           |
|                                 | ??  | Other - please specify                     |
| 6                               | <b>Wetted material</b>                      |  |
|                                 | C2  | 316L SS (1.4435)                           |
|                                 | H2  | Hastelloy® C276 (2.4819)                   |
|                                 | M1  | Monel® 400 (2.4360)                        |
|                                 | ??  | Other - please specify                     |
| 7                               | <b>Flushing connection</b>                  |  |
|                                 | 5   | 2 x ¼" NPT female                          |
|                                 | 6   | 2 x ½" NPT female                          |
| 8                               | ?   | Other - please specify                     |
|                                 | <b>Flushing connection sealing screws</b>   |  |
| 9                               | Z   | Without                                    |
|                                 | 1   | With sealing screw(s)                      |



DIAPHRAGM SEALS

<sup>1</sup> Options 1 through 6 represent flange design with bolt holes  
<sup>2</sup> Traditional ring design - covers 'RF' area; alignment required  
<sup>3</sup> For RTJ/RJF sealing faces, please provide the flange pressure class for the diaphragm seal connection site

Order Code:    1        2        3        4        5        6        7

**910.27 -**

|  |  |  |  |  |  |  |
|--|--|--|--|--|--|--|
|  |  |  |  |  |  |  |
|--|--|--|--|--|--|--|

**ZZZ**

\*Additional order details \_\_\_\_\_  
 (see Page 229)

# SEAL ACCESSORIES

Diaphragm Seals > Seal Accessories > 910.ZA

| 910.ZA Smart Code Configuration <sup>1</sup> |  |  |            |
|--|--|--|------------|
| Field no.                                    | Code   | List price                             |            |
| 1  | <b>Process connection (piping radius)</b>            |  |            |
|  | SP025  | 2½" (radius 1.496")                    | \$211.05   |
|  | SP030  | 3" (radius 1.772")                     | \$211.05   |
|  | SP040  | 4" (radius 2.244")                     | \$211.05   |
|  | SP050  | 5" (radius 2.756")                     | \$211.05   |
|  | SP060  | 6" (radius 3.346")                     | \$211.05   |
|  | SP080  | 8" (radius 3.976")                     | \$211.05   |
|  | SP100  | 10" (radius 5.000")                    | \$211.05   |
|  | SP120  | 12" (radius 5.984")                    | \$211.05   |
| 2  | <b>Upper housing (insert) material</b>               |  |            |
|  | CS   | Carbon steel 1018 nickel-plated        | \$265.45   |
|  | C2   | 316L SS (1.4435)                       | \$211.05   |
|  | T1   | Titanium grade 2 (3.7035)              | \$677.75   |
|  | ??   | Other - please specify                 | on inquiry |
| 3  | <b>Diaphragm (insert) material</b>                   |  |            |
|  | C2   | 316L SS (1.4435)                       | N/C        |
|  | H3   | Hastelloy® B2 (2.4617)                 | \$40.40    |
|  | H2   | Hastelloy® C276 (2.4819)               | \$40.40    |
|  | M1   | Monel® 400 (2.4360)                    | \$24.10    |
|  | I1   | Inconel® 600 (2.4816)                  | \$32.95    |
|  | I2   | Incoloy 825 (2.4858)                   | \$32.95    |
|  | TL   | Tantalum                               | \$97.45    |
|  | NL   | Nickel                                 | \$31.55    |
|  | T1   | Titanium grade 2 (3.7035) <sup>2</sup> | \$48.10    |
|  | C0   | Carpenter 20                           | \$32.95    |
|  | D1   | Duplex 2205 (1.4462)                   | \$40.55    |
|  | CP   | 316L SS with PTFE-lining               | \$51.05    |
|  | CF   | 316L SS with PFA-coating               | \$33.10    |
|  | ??   | Other - please specify                 | on inquiry |
| 4  | <b>Lower housing (saddle material)</b>               |  |            |
|  | CS   | Carbon steel 1018, nickel-plated       | \$165.80   |
|  | C2   | 316L SS (1.4435)                       | \$236.00   |
|  | H2   | Hastelloy® C276 (2.4819)               | on inquiry |
|  | ??   | Other - please specify                 | on inquiry |
| 5  | <b>Gasket material</b>                               |  |            |
|  | V  | Viton® (FPM) - max. 400°F              | N/C        |
|  | P  | Teflon® (PTFE) max. 500°F              | \$10.55    |
| ?  | Other - please specify                               | on inquiry                             |            |
| 6  | <b>Fastening parts (retainer flange &amp; bolts)</b> |  |            |
|  | G  | Galvanized steel                       | N/C        |
|  | P  | Stainless steel                        | \$120.75   |
|  | ?  | Other - please specify                 | on inquiry |



DIAPHRAGM SEALS

<sup>1</sup> 910.ZA configuration includes insert and saddle - consult factory to order separately

<sup>2</sup> Titanium diaphragm requires a titanium upper housing

Order Code:                    1                    2                    3                    4                    5                    6

**910.ZA -**       **ZZZ**

\*Additional order details \_\_\_\_\_  
(see Page 229)

# GENERAL SEAL INFORMATION

Diaphragm Seals > General Seal Information > Request For Quote Form

## Request For Quote Form

This form contains spaces for all pertinent information when selecting the proper diaphragm seal. Please make a copy of this form and fill in as much information as you have available when requesting quotations or technical help from the factory.

Contact name: \_\_\_\_\_ Date: \_\_\_\_\_  
 \_\_\_\_\_

Company name: \_\_\_\_\_





Telephone # \_\_\_\_\_ Fax #: \_\_\_\_\_

E-mail Address \_\_\_\_\_



Please choose one of the three possible instruments below:

### SECTION 1

**Gauge**  Type # \_\_\_\_\_  
 Case size (inches): [ 2" ] [ 2½" ] [ 3½" ] [ 4" ] [ 4½" ] [ 6" ]  
 Range: \_\_\_\_\_ to \_\_\_\_\_ [ psi ] [ bar ] Other \_\_\_\_\_

-or- Location of instrument connection: [ LM ]  [ LBM ]  [ CBM ]   
 Instrument connection size and type: [ ¼" NPT ] [ ½" NPT ] [ female ]  [ male ]  Other \_\_\_\_\_

**Transmitter**  Type# \_\_\_\_\_  
 Range: \_\_\_\_\_ to \_\_\_\_\_ [ psi ] [ bar ] Other \_\_\_\_\_

Instrument connection size and type: [ ¼" NPT ] [ ½" NPT ] [ female ]  [ male ]  Other \_\_\_\_\_

**Switch**  Please provide specifics \_\_\_\_\_  
 \_\_\_\_\_

Pressure switch point (upscale): \_\_\_\_\_ [ psi ] [ bar ] Other \_\_\_\_\_

Pressure switch point (downscale): \_\_\_\_\_ [ psi ] [ bar ] Other \_\_\_\_\_

### SECTION 2

#### Process Media

Common Name / Description: Example: Sulfuric Acid 90% Conc. \_\_\_\_\_

Temperature (°C): Process @ max. pressure: min. \_\_\_\_\_ normal \_\_\_\_\_ max. \_\_\_\_\_

Transmitter/gauge: min. \_\_\_\_\_ normal \_\_\_\_\_ max. \_\_\_\_\_

Ambient: min. \_\_\_\_\_ normal \_\_\_\_\_ max. \_\_\_\_\_

Pressure (psi): Static (working press.): min. \_\_\_\_\_ normal \_\_\_\_\_ max. \_\_\_\_\_

Vacuum (psia @ °C): normal \_\_\_\_\_ @ \_\_\_\_\_ °C

max. \_\_\_\_\_ @ \_\_\_\_\_ °C

DIAPHRAGM SEALS

# GENERAL SEAL INFORMATION



Diaphragm Seals > General Seal Information > Request For Quote Form

## Request For Quote Form continued

### SECTION 3

#### Diaphragm Seal

Type number: \_\_\_\_\_

Process connection: Threaded: [ 1/8" NPT ] [ 1/4" NPT ] [ 1/2" NPT ] [ 3/4" NPT ] [ 1" NPT ]; [ male ]  [ female ] 

Sanitary: [ 3/4" ] [ 1" ] [ 1 1/2" ] [ 2" ] [ 3" ] [ 4" ] Other \_\_\_\_\_ ; [ Tri-clover ] or Other \_\_\_\_\_

Pipe/flange size: [ 1/2" ] [ 3/4" ] [ 1" ] [ 1 1/2" ] [ 2" ] [ 3" ] [ 4" ] Other \_\_\_\_\_

ASME pressure classification: [ 150# ] [ 300# ] [ 600# ] [ 900# ] Other \_\_\_\_\_

Instrument connection: [ 1/4" NPT ] [ 1/2" NPT ] [ male ]  [ female ]  [ Capillary ]

Flushing connection: [ Yes ] [ No ] If Yes; [ 1/8" NPT ] [ 1/4" NPT ] [ 1/2" NPT ]

Diaphragm: [ Clamped ] [ Welded ]

Type # 990.29 & 990.35 Extension Length: [ 2" ] [ 3" ] [ 4" ] [ 6" ] Other \_\_\_\_\_

### SECTION 4

#### Materials for Diaphragm Seal

Diaphragm: [ 316SS ] [ HastC276 ] Other \_\_\_\_\_

Additional wetted: [ CS/Nickel ] [ 316SS ] [ HastB2 ] [ HastC276 ] [ Monel® ] [ Tant. ] Other \_\_\_\_\_  
[ Teflon® ]

Non-wetted (flange and support ring): [ CS/Nickel ] [ SS ] Other \_\_\_\_\_

Gasket: [ Viton® ] [ Teflon® ] [ 316SS/Ag ] [ Buna-N ] Other \_\_\_\_\_

Nuts and bolts: [ CS ] [ SS ] Other \_\_\_\_\_

### SECTION 5

#### Instrument Mounting

Type: [ Direct ] [ Cooling element ] [ Capillary ]

Length of capillary: \_\_\_\_\_ Feet (5 feet increments, 50 feet max. limit)

Type of capillary: [ Armor ] [ No armor ] [ PVC coated armor ]

Height difference: \_\_\_\_\_ ft. [ Instrument below seal ] [ Seal below instrument ]

Connection: [ 1/4" NPT ] [ 1/2" NPT ] [ male ]  [ female ]  [ welded ]

System fill fluid [ Glycerine ] [ Silicone ] [ Halocarbon® ] [ Mineral oil ] [ Food grade silicone ]  
[ High temp. oil ] [ Fluorolube® ] [ DC200-10 ] Other \_\_\_\_\_

Special requirements Please specify  
Sanitary - Autoclave [ Yes ] [ No ]

Technical assistance Is technical assistance, collaboration or simulation required for the above diaphragm seal application?  
[ Yes ] [ No ]

# GENERAL SEAL INFORMATION

Diaphragm Seals > General Seal Information > Assembly for Diaphragm Seals

## Assembly for Diaphragm Seals

Assembly of the diaphragm seal and capillary or cooling element to the pressure instrumentation includes filling liquid, sealing, securing the displacement system and calibration at room temperature.

Extra charges apply to instrument mounting brackets, calibration other than room temperature, calibration certifications, additional modifications, transmitter assembly and for “at level” differences between the instrument and the diaphragm seal. Consult factory for more information.

For the following assemblies:

| Diaphragm Seal Assembly<br>For Use with Pressure Gauges and Pressure Switches |                              |               |                           |                  |                              |  |                           |                           |                         |
|---|------------------------------|---------------|---------------------------|------------------|------------------------------|--|---------------------------|---------------------------|-------------------------|
| Application   | Fill fluid <sup>1</sup>      | Code no.      | Temp min/max <sup>6</sup> | Mini seal direct | Direct mounting <sup>2</sup> | With cooling element or capillary up to 9' | With capillary 10' to 19' | With capillary 20' to 29' | With capillary over 29' |
| Standard  | Silicone oil                 | KN2           | -4 to +392°F              | \$44.10          | \$106.40                     | \$141.70                                   | \$177.45                  | \$195.70                  | \$219.80                |
|   |                              |               |                           | 281              | 219                          | 220  | 221                       | 222                       | 223                     |
| Low temp.   | Silicone oil                 | KN17          | -130 to +176°F            | \$44.10          | \$106.40                     | \$141.70                                   | \$177.45                  | \$195.70                  | \$219.80                |
|   |                              |               |                           | 370              | 238                          | 296  | 269                       | 273                       | 349                     |
| Food application  | Glycerine <sup>3</sup>       | KN7           | +60 to +462°F             | \$31.35          | \$62.60                      |  | N/A                       | N/A                       | N/A                     |
|   |                              |               |                           | 280              | 215                          |  |                           |                           |                         |
|   | Glycerine/water <sup>3</sup> | KN12          | +14 to +248°F             | \$31.35          | \$62.60                      | \$93.65                                    | \$106.65                  | \$130.25                  | \$177.45                |
|   |                              |               |                           |                  | 216                          | 298  |                           | 308                       |                         |
| Medicinal White Mineral oil   | KN92                         | +14 to +400°F | \$36.60                   | \$72.90          | \$103.20                     | \$123.65                                   | \$152.35                  | \$207.34                  |                         |
|   |                              |               | 4231                      | 2621             | 2951                         | 3511                                       | 3441                      | 425                       |                         |
| Food grade Silicone oil   | KN93                         | 0 to 372°F    | \$44.10                   | \$106.40         | \$141.70                     | \$177.45                                   | \$195.70                  | \$219.80                  |                         |
|   |                              |               | 363                       | 263              | 264                          | 309  |                           |                           |                         |
| High temp   | High temp oil <sup>4,5</sup> | KN32          | -4 to +750°F              | N/A              | \$286.45                     | \$370.25                                   | \$443.85                  | \$594.45                  | \$767.05                |
|   |                              |               |                           |                  | 335                          | 348  | 328                       | 345                       | 364                     |
| Inert   | Halocarbon <sup>®</sup> 6.3  | KN21          | -40 to +347°F             | \$49.65          | \$130.25                     | \$164.60                                   | \$201.55                  | \$224.15                  | \$293.60                |
|   |                              |               |                           | 283              | 212                          | 213  | 247                       | 248                       | 249                     |
|   | Fluorolube <sup>®</sup> FS-5 | KN 8          | -40 to +392°F             | \$49.65          | \$130.25                     | \$164.60                                   | \$201.55                  | \$224.15                  | \$293.60                |
|   |                              |               |                           | 369              | 240                          | 365  | 329                       |                           | 366                     |

<sup>1</sup> Contact factory for additional system fill fluids

<sup>2</sup> Not available for Type 990.28

<sup>3</sup> Not recommended for vacuum or compound ranges

<sup>4</sup> All threads welded during assembly

<sup>5</sup> +14°F when used with transmitters

<sup>6</sup> Temperature ranges atmospheric gauge pressure & up

# GENERAL SEAL INFORMATION

Diaphragm Seals > General Seal Information > Diaphragm Seal Additional Requirement Coding

| <b>Instrument Mounting Options (please select one)</b>   | <b>Code</b>             | <b>List Price</b> |
|--|-------------------------|-------------------|
| No pressure instrument   | DSZZZ                   | on inquiry        |
| Direct assembly  | DZZZZ                   | N/C               |
| Stainless steel cooling element, 4" length   | KZSZZ (connection)      | \$312.90          |
| Stainless steel unarmored capillary <sup>1</sup>   | MK0 (length,connection) |                   |
| 5' length, 1/4" NPT female to instrument   | MK0F1 (1/4NPTF)         | \$128.95          |
| 5' length, 1/2" NPT female to instrument   | MK0F1 (1/2NPTF)         | \$144.60          |
| Additional cost for lengths over 5'  |                         | \$13.20 per ft.   |
| Stainless steel armored capillary <sup>1</sup>   | MK1 (length,connection) |                   |
| 5' length, 1/4" NPT female to instrument   | MK1 F1 (1/4NPTF)        | \$138.30          |
| 5' length, 1/2" NPT female to instrument   | MK1 F1 (1/2NPTF)        | \$144.60          |
| Additional cost for lengths over 5'  |                         | \$18.25 per ft.   |
| Additional cost for PVC coating  | MK2 (length,connection) | \$6.65 per ft.    |
| <b>Connection To Seal (please select one)</b>  | <b>Code</b>             | <b>List Price</b> |
| 1/4" NPT female  | N4                      | N/C               |
| 1/2" NPT female  | N2                      | N/C               |
| Weld-in connection <sup>2</sup>  | WI                      | N/C               |
| Other - please specify   | ??                      | on inquiry        |
| <b>Additional Options (multiple selections available)</b>  | <b>Code</b>             | <b>List Price</b> |
| None required  | ZZZZ                    | N/C               |
| Vacuum service   | VACU                    | on inquiry        |
| Tack-weld instrument to seal (stainless steel only)  | SSTW                    | \$19.80           |
| Back-weld instrument to seal (stainless steel only)  | SSBW                    | \$59.00           |
| Gauge support - 4" overhang with stainless steel adapter   |                         |                   |
| Aluminum support, 1/4" NPT adapter   | ALMT (4380866)          | \$120.40          |
| Aluminum support, 1/2" NPT adapter   | ALMT (4295898)          | \$120.40          |
| Stainless steel support, 1/4" NPT adapter  | SSMT (4380857)          | \$195.35          |
| Stainless steel support, 1/2" NPT adapter  | SSMT (4384046)          | \$195.35          |
| <b>Quality Certifications (multiple selections available)</b>  | <b>Code</b>             | <b>List Price</b> |
| None required  | ZZZ                     | N/C               |
| Certificate of Compliance to Industry Standards  | COC                     | N/C               |
| Certificate of Origin  | COO                     | N/C               |
| Certificate of Oxygen Cleanliness to ASME B40.100 Level IV   | OXY                     | \$60.65           |
| N.I.S.T. Certificate of Calibration For Seal System  | NIST                    | see page 262      |
| Material Certificate 3.1 (MTR) per EN 10201  | MTR                     | see page 262      |
| Certificate of Compliance to NACE MR-0175/MR-0103  | NACE                    | see page 262      |
| Hydrostatic Test 3.1 per EN 10201 - 1.3X FS, 5 minutes   | HYD13                   | see page 262      |
| Hydrostatic Test 3.1 per EN 10201 - 2.0X FS, 15 minutes  | HYD20                   | see page 262      |
| <sup>1</sup> Standard I.D. is 0.079"; others available. Refer to Datasheet ACS 90.MO for additional options.<br><sup>2</sup> Only offered for cooling element or capillary line mounting to seals with 316L SS upper housings. |                         |                   |
| <b>Diaphragm Seal Assembly Ordering Format</b>   |                         |                   |
| Instrument   | _____                   |                   |
| Diaphragm  | _____                   |                   |
| Additional Requirements  | _____                   |                   |
| Quality Certifications   | _____                   |                   |

DIAPHRAGM SEALS

# BIMETAL THERMOMETERS

Mechanical Temperature > Bimetal Thermometers > TI.1005, TI.ST, TI.20

|             |                                |
|-------------|--------------------------------|
| Type        | <b>TI.1005</b>                 |
| Category    | <b>Pocket Test Thermometer</b> |
| Connection  | Plain                          |
| Dial size   | <b>1"</b>                      |
| Stem length | 5"                             |
| Scale       | °F                             |
| List price  | <b>\$27.25</b>                 |
| -40/160 °F  | <b>1005219D</b>                |
| 0-220 °F    | <b>1005223D</b>                |
| 50/550 °F   | <b>1005216D</b>                |



|             |                                  |
|-------------|----------------------------------|
| Type        | <b>TI.ST</b>                     |
| Category    | <b>Surface Mount Thermometer</b> |
| Connection  | Surface                          |
| Dial size   | <b>2"</b>                        |
| Stem length | N/A                              |
| Scale       | °F or °C                         |
| List price  | <b>\$29.50</b>                   |
| 0/250 °F    | <b>ST206MW</b>                   |
| 0/500 °F    | <b>ST228MW</b>                   |
| -20/120 °C  | <b>ST106MW</b>                   |
| -70/70 °C   | <b>ST101MW</b>                   |



|                            |                               |
|----------------------------|-------------------------------|
| Type                       | <b>TI.20</b>                  |
| Category                   | <b>Industrial Thermometer</b> |
| Connection                 | ¼" NPT Back                   |
| Dial size                  | <b>2"</b>                     |
| Stem length <sup>1</sup>   | 2½"                           |
| Scale                      | °F & °C                       |
| List price                 | <b>\$49.35</b>                |
| 0/250 °F & °C <sup>2</sup> | <b>20025D006G2</b>            |



1) Stem length available from 2½" to 24"

2) Ranges from -100 °F (-70 °C) to 1,000 °F (550 °C)

Factory stocked items shown in **bold print**. Items without part numbers are available - consult factory.



# BIMETAL THERMOMETERS

Mechanical Temperature > Bimetal Thermometers > TI.T20/TI.T17

## Type TI.T20 / TI.T17

Sample Part Number: T20 050 2 24 D0 G 0 S C

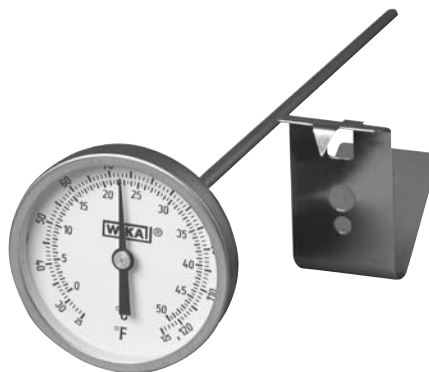
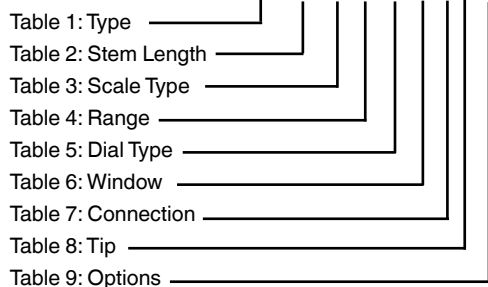

| Table 1 & 2 - Type and stem length  |         |         |         |         |         |         |
|-------------------------------------|---------|---------|---------|---------|---------|---------|
| Type TI.T17 - 1 3/4" Back connected |         |         |         |         |         |         |
| List price                          | \$35.55 | \$35.55 | \$35.55 | \$41.15 | \$51.20 | \$60.25 |
| Stem length                         | 2.5"    | 5"      | 8"      | 12"     | 15"     | 18"     |
| Code                                | 025     | 050     | 080     | 120     | 150     | 180     |
| Type TI.T20 - 2" Back connected     |         |         |         |         |         |         |
| List price                          | \$39.75 | \$39.75 | \$39.75 | \$50.65 | \$58.85 | \$65.20 |
| Stem length                         | 2.5"    | 5"      | 8"      | 12"     | 15"     | 18"     |
| Code                                | 025     | 050     | 080     | 120     | 150     | 180     |

| Table 3 - Scale type |                    |            |
|----------------------|--------------------|------------|
| Code                 | Description        | List price |
| 0                    | Dual scale °F & °C | N/C        |
| 1                    | °C Only            | N/C        |
| 2                    | °F Only            | N/C        |

| Table 4 - Standard ranges |                      |           |           |
|---------------------------|----------------------|-----------|-----------|
| Code                      | Description          | °C Only   | °F Only   |
| 03 <sup>1)</sup>          | 25/125°F & -5/50°C   | 0/50°C    | 25/125°F  |
| 04 <sup>2)</sup>          | 0/140°F & -20/60°C   | N/A       | 0/140°F   |
| 05 <sup>2)</sup>          | 0/200°F & -15/90°C   | 0/100°C   | 0/200°F   |
| 08                        | 50/300°F & 10/150°C  | 0/150°C   | 50/300°F  |
| 10 <sup>2)</sup>          | 50/500°F & 10/260°C  | 0/250°C   | 50/500°F  |
| 11                        | 150/750°F & 65/400°C | 0/300°C   | 150/750°F |
| 19 <sup>2)</sup>          | -40/160°F & -40/70°C | -40/70°C  | -40/160°F |
| 24 <sup>2)</sup>          | 0/220°F & -10/110°C  | -10/110°C | 0/220°F   |
| 34 <sup>2)</sup>          | 0/180°F & -18/82°C   | -18/82°C  | 0/180°F   |

1) Minimum 3" stem - all connectors

2) Minimum 3" stem threaded connections

| Table 5 - Dial type |               |            |
|---------------------|---------------|------------|
| Code                | Description   | List price |
| D0                  | WIKA standard | N/C        |

| Table 6 - Window |             |            |
|------------------|-------------|------------|
| Code             | Description | List price |
| G                | Glass       | N/C        |
| L                | Lexan®      | N/C        |

| Table 7 - Connection |             |            |
|----------------------|-------------|------------|
| Code                 | Description | List price |
| 0                    | Plain       | N/C        |
| 1                    | 1/8" NPT*   | \$11.55    |
| 2                    | 1/4" NPT*   | \$9.60     |

\* No external adjustment

| Table 8 - Tip |             |            |
|---------------|-------------|------------|
| Code          | Description | List price |
| S             | Sharp       | N/C        |
| B             | Blunt       | N/C        |

| Table 9 - Options |             |            |
|-------------------|-------------|------------|
| Code              | Description | List price |
| C                 | Beaker clip | N/C        |
| 0                 | None        | N/C        |

Factory stocked items shown in **bold print**. Items without part numbers are available - consult factory.

# BIMETAL THERMOMETERS

Mechanical Temperature > Bimetal Thermometers > TI.30/TI.50, TI.31/TI.51

## Type TI.30 / TI.50

| Type            | TI.30                                 |                    |                    |             |             |
|-----------------|---------------------------------------|--------------------|--------------------|-------------|-------------|
| Category        | Process Grade Thermometer, Resettable |                    |                    |             |             |
| Connection      | ½" NPT back                           |                    |                    |             |             |
| Dial size       | 3"                                    |                    |                    |             |             |
| Stem length     | 2½"                                   | 4"                 | 6"                 | 9"          | 12"         |
| List price      | \$60.00                               | \$60.00            | \$60.00            | \$60.00     | \$67.20     |
| -40/120 °F      | 30025D202G4                           | 30040D202G4        | 30060D202G4        | 30090D202G4 | 30120D202G4 |
| 0/250 °F        | <b>30025D206G4</b>                    | <b>30040D206G4</b> | <b>30060D206G4</b> | 30090D206G4 | 30120D206G4 |
| 50/550 °F       | <b>30025D216G4</b>                    | <b>30040D216G4</b> | 30060D216G4        | 30090D216G4 | 30120D216G4 |
| -40/120 °F & °C | 30025D002G4                           | 30040D002G4        | 30060D002G4        | 30090D002G4 | 30120D002G4 |
| 0/250 °F & °C   | <b>30025D006G4</b>                    | <b>30040D006G4</b> | <b>30060D006G4</b> | 30090D006G4 | 30120D006G4 |
| 50/500 °F & °C  | 30025D010G4                           | 30040D010G4        | 30060D010G4        | 30090D010G4 | 30120D010G4 |



| Type            | TI.50                                 |             |             |             |
|-----------------|---------------------------------------|-------------|-------------|-------------|
| Category        | Process Grade Thermometer, Resettable |             |             |             |
| Connection      | ½" NPT back                           |             |             |             |
| Dial size       | 5"                                    |             |             |             |
| Stem length     | 2½"                                   | 4"          | 6"          | 9"          |
| List price      | \$88.60                               | \$88.60     | \$88.60     | \$88.60     |
| -40/120 °F      | 50025D202G4                           | 50040D202G4 | 50060D202G4 | 50090D202G4 |
| 0/250 °F        | 50025D206G4                           | 50040D206G4 | 50060D206G4 | 50090D206G4 |
| 50/550 °F       | 50025D216G4                           | 50040D216G4 | 50060D216G4 | 50090D216G4 |
| -40/120 °F & °C | 50025D002G4                           | 50040D002G4 | 50060D002G4 | 50090D002G4 |
| 0/250 °F & °C   | 50025D006G4                           | 50040D006G4 | 50060D006G4 | 50090D006G4 |
| 50/500 °F & °C  | 50025D010G4                           | 50040D010G4 | 50060D010G4 | 50090D010G4 |



MECHANICAL TEMP

## Type TI.31 / TI.51

| Type        | TI.31                                 |             |             |
|-------------|---------------------------------------|-------------|-------------|
| Category    | Process Grade Thermometer, Resettable |             |             |
| Connection  | ½" NPT lower                          |             |             |
| Dial size   | 3"                                    |             |             |
| Stem length | 2½"                                   | 4"          | 6"          |
| List price  | \$101.60                              | \$101.60    | \$101.60    |
| -40/120 °F  | 31025D202G4                           | 31040D202G4 | 31060D202G4 |
| 0/250 °F    | 31025D206G4                           | 31040D206G4 | 31060D206G4 |
| 50/550 °F   | 31025D216G4                           | 31040D216G4 | 31060D216G4 |



TI.51 5" dial thermometer also available - consult factory for details.

Factory stocked items shown in **bold print**.  
Items without part numbers are available - consult factory.

# BIMETAL THERMOMETERS

Mechanical Temperature > Bimetal Thermometers > TI.32/TI.52, TI.33/TI.53

## Type TI.32 / TI.52

| Type        | TI.32                     |                    |             |             |             |
|-------------|---------------------------|--------------------|-------------|-------------|-------------|
| Category    | Process Grade Thermometer |                    |             |             |             |
| Connection  | ½" NPT all angle          |                    |             |             |             |
| Dial size   | 3"                        |                    |             |             |             |
| Stem length | 2½"                       | 4"                 | 6"          | 9"          | 12"         |
| List price  | \$118.30                  | \$118.30           | \$118.30    | \$118.30    | \$129.60    |
| -40/120 °F  | 32025D202G4               | 32040D202G4        | 32060D202G4 | 32090D202G4 | 32120D202G4 |
| 0/250 °F    | <b>32025D206G4</b>        | <b>32040D206G4</b> | 32060D206G4 | 32090D206G4 | 32120D206G4 |
| 50/550 °F   | 32025D216G4               | <b>32040D216G4</b> | 32060D216G4 | 32090D216G4 | 32120D216G4 |



| Type            | TI.52                     |                    |                    |             |             |
|-----------------|---------------------------|--------------------|--------------------|-------------|-------------|
| Category        | Process Grade Thermometer |                    |                    |             |             |
| Connection      | ½" NPT all angle          |                    |                    |             |             |
| Dial size       | 5"                        |                    |                    |             |             |
| Stem length     | 2½"                       | 4"                 | 6"                 | 9"          | 12"         |
| List price      | \$138.20                  | \$138.20           | \$138.20           | \$138.20    | \$152.25    |
| -40/120 °F      | 52025D202G4               | <b>52040D202G4</b> | <b>52060D202G4</b> | 52090D202G4 | 52120D202G4 |
| 0/250 °F        | 52025D206G4               | 52040D206G4        | 52060D206G4        | 52090D206G4 | 52120D206G4 |
| 50/550 °F       | 52025D216G4               | 52040D216G4        | <b>52060D216G4</b> | 52090D216G4 | 52120D216G4 |
| -40/120 °F & °C | 52025D002G4               | 52040D002G4        | 52060D002G4        | 52090D002G4 | 52120D002G4 |
| 0/250 °F & °C   | 52025D006G4               | <b>52040D006G4</b> | 52060D006G4        | 52090D006G4 | 52120D006G4 |
| 50/500 °F & °C  | 52025D010G4               | 52040D010G4        | 52060D010G4        | 52090D010G4 | 52120D010G4 |



## Type TI.33 / TI.53

| Type        | TI.33                        |                    |                    |             |
|-------------|------------------------------|--------------------|--------------------|-------------|
| Category    | Industrial Grade Thermometer |                    |                    |             |
| Connection  | ½" NPT back                  |                    |                    |             |
| Dial size   | 3"                           |                    |                    |             |
| Stem length | 2½"                          | 4"                 | 6"                 | 9"          |
| List price  | \$49.65                      | \$49.65            | \$49.65            | \$49.65     |
| 0/250 °F    | <b>33025D206G4</b>           | <b>33040D206G4</b> | <b>33060D206G4</b> | 33090D206G4 |
| 50/550 °F   | <b>33025D216G4</b>           | 33040D216G4        | <b>33060D216G4</b> | 33090D216G4 |

TI.53 5" dial thermometer also available - consult factory for details.

### Type Descriptions

- Type 33 (TI.33) = 3" back connection
- Type 34 (TI.34) = 3" bottom connection
- Type 53 (TI.53) = 5" back connection
- Type 54 (TI.54) = 5" bottom connection

Factory stocked items shown in **bold print**.  
Items without part numbers are available - consult factory.



MECHANICAL TEMP

# BIMETAL THERMOMETERS

Mechanical Temperature > Bimetal Thermometers > Ordering Bimetal Thermometers

Sample Part Number: 30 025 D 2 06 G 4 XX X X

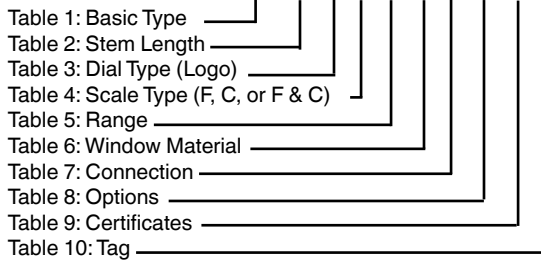

| Process grade - resettable |                     | Industrial grade - non-resettable |                     |
|----------------------------|---------------------|-----------------------------------|---------------------|
| Type                       | Description         | Type                              | Description         |
| 30                         | 3" Back connected   | 20                                | 2" Back connected   |
| 31                         | 3" Bottom connected | 33                                | 3" Back connected   |
| 32                         | 3" Adjustable angle | 34                                | 3" Bottom connected |
| 50                         | 5" Back connected   | 53                                | 5" Back connected   |
| 51                         | 5" Bottom connected | 54                                | 5" Bottom connected |
| 52                         | 5" Adjustable angle |                                   |                     |

Stem lengths above 24" are not available with non-resettable models

| Stem length                     | 2.5" - 9" | 12"      | 15"      | 18"      | 24"      | 30"      | 36"   | 42"      | 48"      | 54"      | 60"      | 66"      | 72"      |          |
|---------------------------------|-----------|----------|----------|----------|----------|----------|---|----------|----------|----------|----------|----------|----------|----------|
| Code                            | 025-090   | 120      | 150      | 180      | 240      | 300      | 360   | 420      | 480      | 540      | 600      | 660      | 720      |          |
| Process grade resettable        | 30        | \$60.00  | \$67.20  | \$72.80  | \$80.50  | \$97.35  | \$112.40  | \$127.45 | \$142.45 | \$157.55 | \$175.60 | \$193.50 | \$232.35 | \$263.10 |
|                                 | 31        | \$101.60 | \$113.75 | \$126.65 | \$140.30 | \$147.30 | \$162.35  | \$177.40 | \$192.45 | \$207.55 | \$225.80 | \$243.70 | \$295.55 | \$313.05 |
|                                 | 32        | \$118.35 | \$129.45 | \$135.50 | \$141.20 | \$149.60 | \$164.65  | \$179.70 | \$194.75 | \$209.80 | \$227.75 | \$245.85 | \$285.85 | \$315.20 |
|                                 | 50        | \$88.60  | \$98.75  | \$105.55 | \$114.80 | \$132.10 | \$147.15  | \$162.25 | \$177.30 | \$192.35 | \$210.45 | \$228.50 | \$268.55 | \$297.90 |
|                                 | 51        | \$126.30 | \$139.20 | \$148.80 | \$154.90 | \$162.70 | \$177.85  | \$192.85 | \$207.90 | \$222.95 | \$240.70 | \$259.05 | \$299.05 | \$327.15 |
|                                 | 52        | \$138.20 | \$152.25 | \$159.70 | \$167.95 | \$176.15 | \$191.20  | \$206.25 | \$221.35 | \$236.35 | \$254.35 | \$272.45 | \$312.45 | \$341.80 |
| Industrial grade non-resettable | 20        | \$49.35  | \$56.05  | \$62.75  | \$68.70  | \$85.20  | Stem lengths above 24" are not available with non-resettable models |          |          |          |          |          |          |          |
|                                 | 33        | \$49.65  | \$57.20  | \$63.80  | \$72.10  | \$88.60  |   |          |          |          |          |          |          |          |
|                                 | 34        | \$88.50  | \$96.35  | \$102.75 | \$112.50 | \$121.65 |   |          |          |          |          |          |          |          |
|                                 | 53        | \$80.40  | \$88.25  | \$94.65  | \$103.05 | \$113.65 |   |          |          |          |          |          |          |          |
|                                 | 54        | \$111.35 | \$119.00 | \$122.40 | \$133.90 | \$144.65 |   |          |          |          |          |          |          |          |

| Code | Description        |
|------|--------------------|
| D    | WIKA standard logo |
| X    | Special            |
| A    | TREND              |

| Code | Description        |
|------|--------------------|
| 0    | Dual scale °F & °C |
| 1    | Single scale °C    |
| 2    | Single scale °F    |

| Code              | Dual Scale |             |      |           |             |      | Single Scale |           |
|-------------------|------------|-------------|------|-----------|-------------|------|--------------|-----------|
|                   | °F Range   | Figure Int. | Div. | °C range  | Figure Int. | Div. | °F Range     | °C Range  |
| 01 <sup>3</sup>   | -100/150°F | 20°         | 2°   | -70/70°C  | 10°         | 1°   | -100/150°F   | -70/70°C  |
| 13                | -80/120°F  | 20°         | 2°   | -60/50°C  | 10°         | 1°   | -80/120°F    | -60/50°C  |
| 02                | -40/120°F  | 20°         | 2°   | -40/50°C  | 10°         | 1°   | -40/120°F    | -50/50°C  |
| 14                | -20/120°F  | 20°         | 2°   | -30/50°C  | 10°         | 1°   | -20/120°F    | -30/50°C  |
| 19                | -40/160°F  | 20°         | 2°   | -40/70°   | 10°         | 1°   | -40/160°F    | -40/70°C  |
| 23 <sup>1</sup>   | 0/100°F    | 10°         | 1°   | -20/40°C  | 5°          | ½°   | 0/100°F      | -20/40°C  |
| 03 <sup>1</sup>   | 25/125°F   | 10°         | 1°   | -5/50°C   | 5°          | ½°   | 25/125°F     | 0/50°C    |
| 15 <sup>1</sup>   | 30/130°F   | 10°         | 1°   | 0/55°C    | 5°          | ½°   | 30/130°F     | 0/55°C    |
| 04                | 0/140°F    | 10°         | 1°   | -20/60°C  | 5°          | ½°   | 0/140°F      | -20/60°C  |
| 05                | 0/200°F    | 20°         | 2°   | -15/90°C  | 10°         | 1°   | 0/200°F      | 0/100°C   |
| 06                | 0/250°F    | 20°         | 2°   | -20/120°C | 10°         | 1°   | 0/250°F      | -20/120°C |
| 07                | 20/240°F   | 20°         | 2°   | -5/115°C  | 10°         | 1°   | 20/240°F     | -10/110°C |
| 08                | 50/300°F   | 20°         | 2°   | 10°/150°C | 10°         | 1°   | 50/300°F     | 0/150°C   |
| 09                | 50/400°F   | 50°         | 5°   | 10/200°C  | 20°         | 2°   | 50/400°F     | 0/200°C   |
| 10                | 50/500°F   | 50°         | 5°   | 10/260°C  | 20°         | 2°   | 50/500°F     | 0/250°C   |
| 16 <sup>3</sup>   | 50/550°F   | 50°         | 5°   | 10/290°C  | 20°         | 2°   | 50/550°F     | 10/290°C  |
| 17 <sup>3</sup>   | 0/600°F    | 100°        | 10°  | -20/315°C | 50°         | 5°   | 0/600°F      | -20/315°C |
| 11 <sup>3</sup>   | 150/750°F  | 100°        | 10°  | 65/400°C  | 50°         | 5°   | 150/750°F    | 0/300°C   |
| 18 <sup>3</sup>   | 100/800°F  | 100°        | 10°  | 40/425°C  | 50°         | 5°   | 100/800°F    | 0/450°C   |
| 12 <sup>2,3</sup> | 200/1000°F | 100°        | 10°  | 100/540°C | 50°         | 5°   | 200/1000°F   | 100/550°C |

(1) Not available with 2½" stem  
 (2) Not recommended for continued use over 800°F  
 (3) Silicone fill not available

MECHANICAL TEMP

# BIMETAL THERMOMETERS

Mechanical Temperature > Bimetal Thermometers > Ordering Bimetal Thermometers

| Code           | Description       | Process grade - resettable |        |        |         |         |         | Industrial grade - non-resettable |        |        |         |         |
|----------------|-------------------|----------------------------|--------|--------|---------|---------|---------|-----------------------------------|--------|--------|---------|---------|
|                |                   | 30                         | 31     | 32     | 50      | 51      | 52      | 20                                | 33     | 34     | 53      | 54      |
| A              | Acrylic lens      | \$3.55                     | \$3.55 | \$3.55 | \$5.70  | \$5.70  | \$5.70  | N/A                               | \$3.55 | \$3.55 | \$5.70  | \$5.70  |
| L              | Lexan® lens       | \$7.75                     | \$7.75 | \$7.75 | N/A     | N/A     | N/A     | \$3.80                            | \$7.75 | \$7.75 | N/A     | N/A     |
| S <sup>1</sup> | Shatterproof lens | \$7.75                     | \$7.75 | \$7.75 | \$11.15 | \$11.15 | \$11.15 | N/A                               | \$7.75 | \$7.75 | \$11.15 | \$11.15 |
| G <sup>1</sup> | Glass             | Standard                   |        |        |         |         |         | Standard                          |        |        |         |         |

<sup>1</sup> not available with silicone fill

| Code | Description | Process grade - resettable |         |         |         |         |         | Industrial grade - non-resettable |          |        |        |        |  |
|------|-------------|----------------------------|---------|---------|---------|---------|---------|-----------------------------------|----------|--------|--------|--------|--|
|      |             | 30                         | 31      | 32      | 50      | 51      | 52      | 20                                | 33       | 34     | 53     | 54     |  |
| 0    | Plain conn. | \$3.80                     | \$3.80  | \$3.80  | \$3.80  | \$3.80  | \$3.80  | \$3.80                            | N/A      | \$3.80 | \$3.80 | \$3.80 |  |
| 1    | 1/8 NPT     | N/A                        | N/A     | N/A     | N/A     | N/A     | N/A     | \$3.80                            | N/A      | N/A    | N/A    | N/A    |  |
| 2    | 1/4 NPT     | \$3.80                     | \$3.80  | \$3.80  | \$3.80  | \$3.80  | \$3.80  | Std                               | \$3.80   | \$3.80 | \$3.80 | \$3.80 |  |
| 3    | 3/8 NPT     | \$6.85                     | N/A     | N/A     | \$6.85  | N/A     | N/A     | \$6.85                            | \$6.85   | N/A    | \$6.85 | N/A    |  |
| 4    | 1/2 NPT     | Standard                   |         |         |         |         |         | \$3.80                            | Standard |        |        |        |  |
| 5    | G 1/2 B     | \$11.10                    | \$20.15 | \$20.15 | \$11.10 | \$20.15 | \$20.15 | N/A                               | N/A      | N/A    | N/A    | N/A    |  |
| 7    | Union conn. | N/A                        | N/A     | \$30.70 | N/A     | N/A     | \$30.70 | N/A                               | N/A      | N/A    | N/A    | N/A    |  |

| Code            | Description       | Process grade - resettable |         |         |         |         |         | Industrial grade - non-resettable |        |        |        |        |
|-----------------|-------------------|----------------------------|---------|---------|---------|---------|---------|-----------------------------------|--------|--------|--------|--------|
|                 |                   | 30                         | 31      | 32      | 50      | 51      | 52      | 20                                | 33     | 34     | 53     | 54     |
| DM              | Dampened movement | \$14.50                    | \$14.50 | \$14.50 | \$14.50 | \$14.50 | \$14.50 | N/A                               | N/A    | N/A    | N/A    | N/A    |
| SF              | Silicone fill     | \$36.10                    | \$43.20 | \$43.20 | \$43.20 | \$50.25 | \$50.25 | N/A                               | N/A    | N/A    | N/A    | N/A    |
| ST              | Sharp tip         | \$4.60                     | \$4.60  | \$4.60  | \$4.60  | \$4.60  | \$4.60  | \$4.60                            | \$4.60 | \$4.60 | \$4.60 | \$4.60 |
| MM              | Min/Max pointer   | \$46.90                    | N/A     | N/A     | \$47.55 | N/A     | N/A     | N/A                               | N/A    | N/A    | N/A    | N/A    |
| LS              | Left side         | N/A                        | N/C     | N/A     | N/A     | N/C     | N/A     | N/A                               | N/A    | N/A    | N/A    | N/A    |
| RS              | Right side        | N/A                        | N/C     | N/A     | N/A     | N/C     | N/A     | N/A                               | N/A    | N/A    | N/A    | N/A    |
| TS              | Top side          | N/A                        | N/C     | N/A     | N/A     | N/C     | N/A     | N/A                               | N/A    | N/A    | N/A    | N/A    |
| DF <sup>2</sup> | Dry w/plug        | \$3.55                     | \$3.55  | \$3.55  | \$3.55  | \$3.55  | \$3.55  | N/A                               | N/A    | N/A    | N/A    | N/A    |

<sup>2</sup> Prepares unit for liquid case filling and shipped dry.

| Code | Description         | 2.5" - 9" | 12"     | 15"     | 18"     | 24"     | 30"     | 36"     | 42"     | 48"     | 54"      | 60"      | 66"      | 72"      |
|------|---------------------|-----------|---------|---------|---------|---------|---------|---------|---------|---------|----------|----------|----------|----------|
| HA   | Full length         | \$41.25   | \$49.35 | \$56.60 | \$60.35 | \$64.15 | \$71.85 | \$79.60 | \$87.20 | \$94.90 | \$102.65 | \$110.25 | \$117.95 | \$125.50 |
| HD   | Reduced tip         | \$41.25   | \$49.35 | \$56.60 | \$60.35 | \$64.15 | \$71.85 | \$79.60 | \$87.20 | \$94.90 | \$102.65 | \$110.25 | \$117.95 | \$125.50 |
| HS   | Reduced w/sharp tip | \$41.25   | \$49.35 | \$56.60 | \$60.35 | \$64.15 | \$71.85 | \$79.60 | \$87.20 | \$94.90 | \$102.65 | \$110.25 | \$117.95 | \$125.50 |

| Code | Description         | 2.5" - 9" | 12"     | 15"     | 18"     | 24"     | 30"     | 36"     | 42"     | 48"     | 54"     | 60"      | 66"      | 72"      |
|------|---------------------|-----------|---------|---------|---------|---------|---------|---------|---------|---------|---------|----------|----------|----------|
| SS   | 316 SS wetted parts | \$39.40   | \$39.40 | \$39.40 | \$39.40 | \$52.55 | \$52.55 | \$52.55 | \$91.90 | \$91.90 | \$91.90 | \$131.20 | \$131.20 | \$131.20 |

| Description                          | Code | List price |
|--------------------------------------|------|------------|
| NIST Factory Certificate of Accuracy | I    | \$151.00   |

| Part number | Description  | List price |
|-------------|--|------------|
| UL          | 1/2" Union locknut   | \$13.90    |
| 85          | T-85 Conv. kit   | \$29.75    |
| ND          | 1/2" NPT Duct flange                                       | \$18.25    |
| 2256045     | 5.3 oz. tube heat transfer compound for use in thermowells | \$39.25    |

| Description         | Code | List price |
|---------------------|------|------------|
| Without             | Z    | N/C        |
| Paper tag           | P    | \$4.00     |
| Stainless steel tag | 2    | \$10.00    |

Certificate of compliance available at no charge

#### ABBREVIATIONS

N/A - this option is not available  
Std - this option comes standard

# DIGITAL THERMOMETERS

Mechanical Temperature > Digital Thermometers > TI.80, TI.82

| Type        | TI.80                     |                 |                 |                 |                 |                 |                 |                 |
|-------------|---------------------------|-----------------|-----------------|-----------------|-----------------|-----------------|-----------------|-----------------|
| Category    | Solar Digital Thermometer |                 |                 |                 |                 |                 |                 |                 |
| Connection  | 1/2" NPT back             |                 |                 |                 |                 |                 |                 |                 |
| Dial size   | 3"                        |                 |                 |                 |                 |                 |                 |                 |
| Stem length | 2 1/2"                    | 4"              | 6"              | 9"              | 12"             | 15"             | 18"             | 24"             |
| List price  | <b>\$226.75</b>           | <b>\$226.75</b> | <b>\$226.75</b> | <b>\$226.75</b> | <b>\$226.75</b> | <b>\$253.00</b> | <b>\$253.00</b> | <b>\$253.00</b> |
| -50/300 °F  | 80025D2G4                 | 80040D2G4       | 80060D2G4       | 80090D2G4       | 80120D2G4       | 80150D2G4       | 80180D2G4       | 80240D2G4       |
| -50/150°C   | 80025D1G4                 | 80040D1G4       | 80060D1G4       | 80090D1G4       | 80120D1G4       | 80150D1G4       | 80180D1G4       | 80240D1G4       |

| Type        | TI.82                         |                 |                 |                 |                 |                 |                 |                 |
|-------------|-------------------------------|-----------------|-----------------|-----------------|-----------------|-----------------|-----------------|-----------------|
| Category    | Solar Digital Thermometer     |                 |                 |                 |                 |                 |                 |                 |
| Connection  | 1/2" NPT All angle adjustable |                 |                 |                 |                 |                 |                 |                 |
| Dial size   | 3"                            |                 |                 |                 |                 |                 |                 |                 |
| Stem length | 2 1/2"                        | 4"              | 6"              | 9"              | 12"             | 15"             | 18"             | 24"             |
| List price  | <b>\$287.90</b>               | <b>\$287.90</b> | <b>\$287.90</b> | <b>\$287.90</b> | <b>\$287.90</b> | <b>\$314.05</b> | <b>\$314.05</b> | <b>\$314.05</b> |
| -50/300 °F  | 82025D2G4                     | 82040D2G4       | 82060D2G4       | 82090D2G4       | 82120D2G4       | 82150D2G4       | 82180D2G4       | 82240D2G4       |
| -50/150°C   | 82025D1G4                     | 82040D1G4       | 82060D1G4       | 82090D1G4       | 82120D1G4       | 82150D1G4       | 82180D1G4       | 82240D1G4       |

| Options     |      |  |  |
|-------------|------|--|--|
|             | Code | Description                                      | List price   |
| Connection  | 0    | Plain  | <b>\$3.80</b>  |
|             | 2    | 1/4" NPT   | <b>\$3.80</b>  |
|             | 3    | 3/8" NPT (TI.80 only)                            | <b>\$6.85</b>  |
| Window      | A    | Acrylic  | <b>\$3.55</b>  |
| Accessories | ST   | Sharp tip  | <b>\$3.55</b>  |
|             | SS   | 316 SS wetted parts                              | <b>\$4.60</b>  |
| Stem        | HD   | 3/8" dia. stem w/ 2 1/2" L x 1/4" dia. tip       | <b>\$41.25 for 1st 6" length; \$7.65 for each add'l 6" (or less)</b> |
|             | HS   | 3/8" dia. stem w/ 2 1/2" L x 1/4" dia. sharp tip | <b>\$41.25 for 1st 6" length; \$7.65 for each add'l 6" (or less)</b> |



TI.80



TI.82

Factory stocked items shown in **bold print**.  
Items without part numbers are available - consult factory.

MECHANICAL TEMP

# TWIN-TEMP THERMOMETERS

Mechanical Temperature > Twin-Temp Thermometers > Ordering Twin-Temp Thermometers

## Type TT.30, TT.32, TT.50, TT.52

Sample Part Number: 30 060 D 0 01 G 4 R1 A R

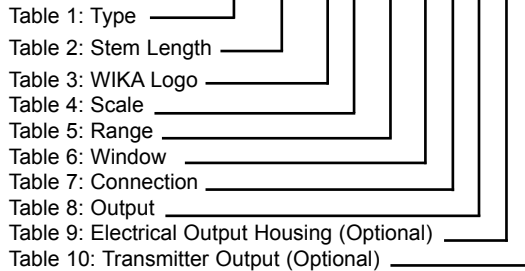

### HOW TO ORDER:

Select the appropriate codes and combine to complete thermometer part number.



TT.52 shown

| Code | Description                    |
|------|--------------------------------|
| 30   | 3" Back connected (with reset) |
| 32   | 3" All angle (with reset)      |
| 50   | 5" Back connected (with reset) |
| 52   | 5" All angle (with reset)      |

| Code | Description  |
|------|--|
| XXX  | Length in inches with one decimal place (XX.X) RTD available only in 4" to 48" (040-480) stem length. Thermocouple available 2½" to 48" (025-480). |

| Stem length | 2.5" | 4"       | 6"       | 9"       | 12"      | 15"      | 18"      | 24"      | 30"      | 36"      | 42"      | 48"      |          |
|-------------|------|----------|----------|----------|----------|----------|----------|----------|----------|----------|----------|----------|----------|
| Code        | 025  | 040      | 060      | 090      | 120      | 150      | 180      | 240      | 300      | 360      | 420      | 480      |          |
| Type        | 30   | \$309.00 | \$309.00 | \$309.00 | \$309.00 | \$309.00 | \$368.00 | \$368.00 | \$368.00 | \$428.00 | \$428.00 | \$488.00 | \$488.00 |
|             | 32   | \$403.00 | \$403.00 | \$403.00 | \$403.00 | \$403.00 | \$462.00 | \$462.00 | \$462.00 | \$522.00 | \$522.00 | \$583.00 | \$583.00 |
|             | 50   | \$360.00 | \$360.00 | \$360.00 | \$360.00 | \$360.00 | \$419.00 | \$419.00 | \$419.00 | \$480.00 | \$480.00 | \$540.00 | \$540.00 |
|             | 52   | \$428.00 | \$428.00 | \$428.00 | \$428.00 | \$428.00 | \$488.00 | \$488.00 | \$488.00 | \$548.00 | \$548.00 | \$608.00 | \$608.00 |

Note: Thermocouple junction is welded to tip of stem

or

| Stem length | 2.5" | 4"  | 6"       | 9"       | 12"      | 15"      | 18"      | 24"      | 30"      | 36"      | 42"      | 48"      |          |
|-------------|------|-----|----------|----------|----------|----------|----------|----------|----------|----------|----------|----------|----------|
| Code        | 025  | 040 | 060      | 090      | 120      | 150      | 180      | 240      | 300      | 360      | 420      | 480      |          |
| Type        | 30   | N/A | \$343.00 | \$343.00 | \$343.00 | \$343.00 | \$403.00 | \$403.00 | \$403.00 | \$462.00 | \$462.00 | \$522.00 | \$522.00 |
|             | 32   | N/A | \$437.00 | \$437.00 | \$437.00 | \$437.00 | \$497.00 | \$497.00 | \$497.00 | \$556.00 | \$556.00 | \$616.00 | \$616.00 |
|             | 50   | N/A | \$394.00 | \$394.00 | \$394.00 | \$394.00 | \$454.00 | \$454.00 | \$454.00 | \$514.00 | \$514.00 | \$574.00 | \$574.00 |
|             | 52   | N/A | \$440.00 | \$440.00 | \$440.00 | \$440.00 | \$522.00 | \$522.00 | \$522.00 | \$583.00 | \$583.00 | \$642.00 | \$642.00 |

Note: RTD is placed in stem above bimetal helix (requires minimum 3½" insertion)

| Code | Description   |
|------|---------------|
| D    | WIKA standard |
| X    | Special       |

| Code | Description        |
|------|--------------------|
| 0    | Dual scale °F & °C |
| 1    | Single scale °C    |
| 2    | Single scale °F    |

### ABBREVIATIONS

N/A - this option is not available

| Code | Dual scale           |                 |                 |
|------|----------------------|-----------------|-----------------|
|      | Dual scale °F & °C   | Single scale °C | Single scale °F |
| 02*  | -40/120°F & -40/50°C | -50/50°C        | -40/120°F       |
| 03*  | 25/125°F & -5/50°C   | 0/50°C          | 25/125°F        |
| 04*  | 0/140°F & -20/60°C   | -20/60°C        | 0/140°F         |
| 05   | 0/200°F & -15/90°C   | 0/100°C         | 0/200°F         |
| 06   | 0/250°F & -20/120°C  | -20/120°C       | 0/250°F         |
| 07   | 20/240°F & -5/115°C  | -10/110°C       | 20/240°F        |
| 08   | 50/300°F & 10/150°C  | 0/150°C         | 50/300°F        |
| 09   | 50/400°F & 10/200°C  | 0/200°C         | 50/400°F        |
| 10   | 50/500°F & 10/260°C  | 0/250°C         | 50/500°F        |
| 16   | 50/550°F & 10/260°C  | 10/290°C        | 50/550°F        |

\* Not available with 2½" stem

# TWIN-TEMP THERMOMETERS

Mechanical Temperature > Twin-Temp Thermometers > Ordering Twin-Temp Thermometers

## Type TT.30, TT.32, TT.50, TT.52 continued

| Code | Description  | 30              | 32            | 50             | 52             |
|------|--------------|-----------------|---------------|----------------|----------------|
| G    | Plain glass  | <b>Standard</b> |               |                |                |
| A    | Acrylic      | <b>\$3.55</b>   | <b>\$3.55</b> | <b>\$6.05</b>  | <b>\$6.05</b>  |
| L    | Lexan®       | <b>\$7.75</b>   | <b>\$7.75</b> | <b>N/A</b>     | <b>N/A</b>     |
| S    | Shatterproof | <b>\$7.75</b>   | <b>\$7.75</b> | <b>\$11.15</b> | <b>\$11.15</b> |

| Code | Description | 30              | 32 | 50 | 52 |
|------|-------------|-----------------|----|----|----|
| 2    | ¼" NPT      | <b>\$3.80</b>   |    |    |    |
| 4    | ½" NPT      | <b>Standard</b> |    |    |    |

Choose an electrical output configuration from either the left column only or right column only.

| Code | Description                                 | List price |
|------|---|------------|
| TJ   | Thermocouple output, Type J (female plug)   | <b>Std</b> |
| TK   | Thermocouple output, Type K (female plug)   | <b>Std</b> |
| TE   | Thermocouple output, Type E (female plug)   | <b>Std</b> |
| TT   | Thermocouple output, Type T (female plug)   | <b>Std</b> |
| RA   | 100 Ohm RTD output, 3-wire (terminal block) | <b>Std</b> |

| Code | Description                 | List price     |
|------|-----------------------------|----------------|
| J1   | Thermocouple output, Type J | <b>\$85.15</b> |
| K1   | Thermocouple output, Type K | <b>\$85.15</b> |
| E1   | Thermocouple output, Type E | <b>\$85.15</b> |
| T1   | Thermocouple output, Type T | <b>\$85.15</b> |
| R1   | 100 Ohm RTD output, 3-wire  | <b>\$85.15</b> |

| Code | Description  | List price     |
|------|--|----------------|
| X    | None   | <b>N/C</b>     |
| J    | Straight barrel weather proof housing (7/8-20 UNEF) & plug | <b>\$61.65</b> |
| K    | Straight barrel weather proof housing (7/8-20 UNEF) & plug | <b>\$61.65</b> |
| E    | Straight barrel weather proof housing (7/8-20 UNEF) & plug | <b>\$61.65</b> |
| T    | Straight barrel weather proof housing (7/8-20 UNEF) & plug | <b>\$61.65</b> |
| R    | Straight barrel weather proof housing (7/8-20 UNEF)        | <b>\$61.65</b> |

| Code | Description                  | List price     |
|------|------------------------------|----------------|
| X    | None                         | <b>N/C</b>     |
| A    | *Std aluminum head enclosure | <b>\$45.25</b> |
| H    | *Exp. Proof Head             | <b>\$77.35</b> |

| Code | Description  | List price |
|------|--|------------|
| X    | None (mandatory on all non-transmitter models, must use this code "X" for all TJ/TK/TE/TT/RA from Table 8) | <b>N/C</b> |

| Code | Description   | List price      |
|------|---|-----------------|
| X    | None (mandatory on all non-transmitter models; must use this code "X" for all TJ/TE/TT/RA from Table 8) | <b>N/C</b>      |
| T    | <sup>1,3</sup> 4-20mA transmitter for all Thermocouple output   | <b>\$228.00</b> |
| R    | <sup>2,3</sup> 4-20mA transmitter for all "R1" RTD output (from Table 8)                                | <b>\$183.00</b> |
| B    | <sup>3</sup> Terminal Block (for field wiring termination, when transmitter not used)                   | <b>\$19.60</b>  |

<sup>1</sup> only compatible with codes J1/K1/E1/T1  
<sup>2</sup> only compatible with code R1  
<sup>3</sup> must use code A or H from Table 9 for enclosure

**ABBREVIATIONS**  
 N/A - this option is not available  
 N/C - there is no charge for this option  
 STD - this option comes standard

|                   |
|-------------------|
| XX/JX/KX/EX/TX/RX |
| AX/AT/AR/AB       |

MECHANICAL TEMP



# TWIN-TEMP THERMOMETERS

Mechanical Temperature > Twin-Temp Thermometers > Ordering Twin-Temp Thermometers

## Type TT.80, TT.82

Sample Part Number: 80 040 D 6 G 4 R1 A R

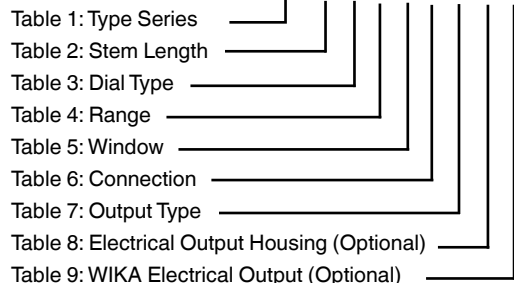

| Table 1 - Basic type |                   |
|----------------------|-------------------|
| Code                 | Description       |
| 80                   | 3" Back connected |
| 82                   | 3" All angle      |

| Table 2 - Stem length |             |                 |                 |
|-----------------------|-------------|-----------------|-----------------|
| Code                  | Description | List price      |                 |
|                       |             | TT.80           | TT.82           |
| 025                   | 2.5"        | <b>\$226.75</b> | <b>\$287.90</b> |
| 040                   | 4"          | <b>\$226.75</b> | <b>\$287.90</b> |
| 060                   | 6"          | <b>\$226.75</b> | <b>\$287.90</b> |
| 090                   | 9"          | <b>\$226.75</b> | <b>\$287.90</b> |
| 120                   | 12"         | <b>\$226.75</b> | <b>\$287.90</b> |
| 150                   | 15"         | <b>\$253.00</b> | <b>\$314.05</b> |
| 180                   | 18"         | <b>\$253.00</b> | <b>\$314.05</b> |
| 240                   | 24"         | <b>\$253.00</b> | <b>\$314.05</b> |

| Table 3 - Dial type |               |
|---------------------|---------------|
| Code                | Description   |
| D                   | WIKA standard |

| Table 4 - ranges |             |
|------------------|-------------|
| Code             | Description |
| 1                | -50/300 °F  |
| 2                | -50/150 °C  |

| Table 5 - Window material |             |               |
|---------------------------|-------------|---------------|
| Code                      | Description | List price    |
| G                         | Plain glass | <b>Std</b>    |
| A                         | Acrylic     | <b>\$3.55</b> |

| Table 6 - Process connection |             |            |
|------------------------------|-------------|------------|
| Code                         | Description | List price |
| 4                            | ½" NPT      | <b>Std</b> |

### HOW TO ORDER:

Select the appropriate codes and combine to complete thermometer part number.



| Table 7 - Electrical output |                             |                |
|-----------------------------|-----------------------------|----------------|
| Code                        | Description                 | List price     |
| J1                          | Thermocouple output, Type J | <b>\$85.15</b> |
| K1                          | Thermocouple output, Type K | <b>\$85.15</b> |
| E1                          | Thermocouple output, Type E | <b>\$85.15</b> |
| T1                          | Thermocouple output, Type T | <b>\$85.15</b> |
| R1                          | 100 Ohm RTD output, 3-wire  | <b>\$85.15</b> |

| Table 8 - Electrical output housing options |                             |                |
|---|-----------------------------|----------------|
| Code  | Description                 | List price     |
| X   | None                        | <b>N/C</b>     |
| A   | Std aluminum head enclosure | <b>\$45.45</b> |

| Table 9 - Transmitter output |   |                 |
|------------------------------|---|-----------------|
| Code                         | Description   | List price      |
| X                            | None  | <b>N/C</b>      |
| T                            | <sup>1,3</sup> 4-20mA transmitter for all Thermocouple output                         | <b>\$228.00</b> |
| R                            | <sup>2,3</sup> 4-20mA transmitter for all "R1" RTD output (from Table 8)              | <b>\$183.00</b> |
| B                            | <sup>3</sup> Terminal Block (for field wiring termination, when transmitter not used) | <b>\$19.60</b>  |

<sup>1</sup> only compatible with codes J1/K1/E1/T1  
<sup>2</sup> only compatible with code R1  
<sup>3</sup> must use code A from Table 8 for enclosure

| Spare parts                           |             |                 |
|---------------------------------------|-------------|-----------------|
| Description                           | Part number | List price      |
| Std aluminum head                     | 102-02      | <b>\$43.95</b>  |
| Terminal block                        | 2246228     | <b>\$19.00</b>  |
| Thermocouple transmitter <sup>1</sup> | 4310853     | <b>\$222.00</b> |
| RTD transmitter <sup>1</sup>          | 4363295     | <b>\$222.00</b> |
| Weather-proof housing                 | TA6S0-0608  | <b>\$56.90</b>  |

<sup>1</sup> When order separate of a Twin-Temp, range must be specified

Factory stocked items shown in **bold print**.  
 Items without part numbers are available - consult factory.

MECHANICAL TEMP

# GAS ACTUATED THERMOMETERS

Mechanical Temperature > Gas Actuated Thermometers > Ordering Gas Actuated Thermometers

## Type TI.R45, TI.R60

Sample Part Number: R45 E L 3 8 7 10 004 00 WI

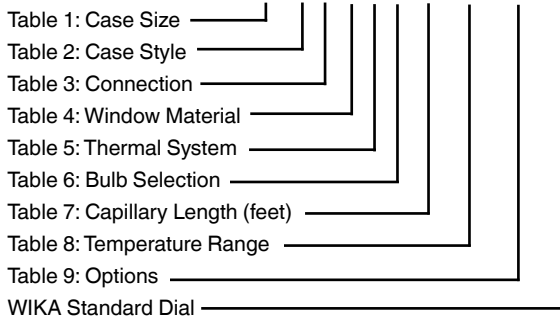

### HOW TO ORDER:

Select the appropriate codes and combine to complete thermometer part number.



| Code | Description | List price |
|------|-------------|------------|
| R45  | 4½" Case    | \$557.00   |
| R60  | 6" Case     | \$743.00   |

| Code | Description                           | Material | Dial size | List price |
|------|---------------------------------------|----------|-----------|------------|
| K    | Back flange, bayonet ring             | SS       | 4½", 6"   | \$104.10   |
| B    | Back flange, bayonet ring             | Aluminum | 4½", 6"   | \$32.15    |
| E    | Turret, threaded ring                 | Phenolic | 4½"       | N/C        |
| F    | Front flange, hinged ring             | Aluminum | 4½", 6"   | \$45.45    |
| S    | Semi-flush front flange, bayonet ring | SS       | 4½", 6"   | \$111.90   |
| U    | U-clamp, bayonet ring                 | SS       | 4½"       | \$155.30   |
|      |                                       |          | 6"        | \$170.30   |
| *V   | Justrite, adjustable angle            | SS       | 4½"       | \$100.65   |
|      |                                       |          | 6"        | \$103.90   |

\* Capillary is not available. Fixed stem length only as specified in Table 6.

| Code | Description      | Case size | Case type                  | List price |
|------|------------------|-----------|----------------------------|------------|
| B    | Back connection  | 4½", 6"   | All                        | N/C        |
| L    | Lower connection | 4½", 6"   | 4½" (K, B, E); 6" (K only) | N/C        |
| *A   | Adjustable angle | 4½", 6"   | V only                     | \$161.75   |

\* Capillary is not available. Fixed stem length only as specified in Table 6.

| Code | Description         | Case size | Case type     | List price |
|------|---------------------|-----------|---------------|------------|
| 3    | Acrylic             | 4½"       | B, E          | \$8.85     |
| 4    | Glass               | 4½", 6"   | All           | N/C        |
| 5    | Shatter-proof glass | 4½"       | E, K, E, U, V | \$23.95    |

### ABBREVIATIONS

N/C - there is no charge for this option

# GAS ACTUATED THERMOMETERS

Mechanical Temperature > Gas Actuated Thermometers > Ordering Gas Actuated Thermometers

## Type TI.R45, TI.R60 continued

| Code | Bulb type                 | Bulb material | Capillary material | Capillary protection | Price w/5' capillary | Per add'l ft |
|------|---------------------------|---------------|--------------------|----------------------|----------------------|--------------|
| 0    | Adjustable angle 1/2" NPT | 316 SS        | N/A                | N/A**                | N/C                  | N/C          |
| 1    | Plain                     | 316 SS        | 316 SS             | Spring armor*        | \$43.15              | \$11.20      |
| 8    | Sliding union 1/2" NPT    | 316 SS        | 316 SS             | Spring armor*        | \$113.55             | \$11.20      |

\* For systems up to 40 ft.; Spiral interlock required on all systems over 40 ft. (see "SI" options, Table 9)  
 \*\* Capillary is not available; fixed stem length only as indicated in Table 6.

| Code   | Description  | To fit thermowells with: |                       | List price |
|--|--|--------------------------|-----------------------|------------|
|  |  | OA length                | Thermowell insertion  |            |
| <b>Adjustable angle</b>                                    |  |                          |                       |            |
| 4  | 3/8" Dia. x 3" length (active), total 4"                 | 4 1/4"                   | U = 2 1/2"            | N/C        |
| 6  | 3/8" Dia. x 3" length (active), total 6"                 | 6 1/4"                   | U = 4 1/2"            | \$23.95    |
| 9  | 3/8" Dia. x 3" length (active), total 9"                 | 9 1/4"                   | U = 7 1/2"            | \$42.80    |
| X  | 3/8" Dia. x 3" length (active), total 12"                | 12 1/4"                  | U = 10 1/2"           | \$76.75    |
| <b>Plain bulb - remote</b>                                 |  |                          |                       |            |
| 1  | 3/8" Dia. x 3" length (active) + 12" rigid extension     |                          |                       | \$30.80    |
| <b>Sliding union (1/2" NPSM) bulb w/bendable extension</b> |  |                          |                       |            |
|  |  | Union                    | Thermowell insertion  |            |
| 7  | 3/8" Dia. x 3" length (active) w/ 12" bendable extension | 3 to 12"                 | U = 2 1/2" to 10 1/2" | N/C        |
| 8  | 3/8" Dia. x 3" length (active) w/ 18" bendable extension | 3 to 18"                 | U = 2 1/2" to 16 1/2" | \$26.55    |

**Special Table 5 & 6 Note:**  
 The only possible thermal system/bulb combinations are as follows:  
 Plain Bulb: (11)  
 Adjustable Angle: (04), (06), (09), (0X)  
 Sliding Union: (87), (88)

Note: Gas-actuated thermometers use standard process type 3/8" bore thermowells, if required. Order separately.

| Code | Description           | List price  |
|------|-----------------------|-------------|
| 05   | 5 feet                | N/C         |
| 10   | 10 feet               | See Table 5 |
| 20   | 20 feet               | See Table 5 |
| 30   | 30 feet               | See Table 5 |
| 40   | 40 feet               | See Table 5 |
| *50  | 50 feet               | See Table 5 |
| *80  | 80 feet               | See Table 5 |
| XX   | Adjustable angle case | N/C         |

\* Requires "SI" option, see Table 9

**Note:**  
 Capillary can be configured to any whole foot, 99' and below. I.E. - 08 = 8' capillary

| Code  | Dual scale °F & °C |           | List price  |
|-------|--------------------|-----------|-------------|
| *001  | -320/100°F         | -200/40°C | See Table 9 |
| 002   | -120/120°F         | -80/50°C  | N/C         |
| 003   | 0/120°F            | -20/50°C  | N/C         |
| 004   | 0/160°F            | -20/70°C  | N/C         |
| 005   | -40/180°F          | -40/80°C  | N/C         |
| 006   | 20/240°F           | -10/115°C | N/C         |
| 007   | 0/300°F            | -20/150°C | N/C         |
| 008   | 50/550°F           | 0/300°C   | N/C         |
| 009   | 50/750°F           | 0/400°C   | N/C         |
| **010 | 400/1200°F         | 200/650°C | See Table 9 |
| 11    | 50/400°F           | 0/200°C   | N/C         |

\* Requires "LT" option, See Table 9  
 \*\* Requires "HT" option, See Table 9

**Note:**  
 Ranges marked with an asterisk indicated in Table 8 reference Table 9 and require additional cost as indicated.

| Code  | Description                        | Case size | Case type | List price  |
|-------|------------------------------------|-----------|-----------|---|
| 00    | Without accessories                | All       | All       | N/C   |
| FR    | Flush mounting ring                | 4 1/2"    | E         | \$74.70   |
| *LT   | Low temperature (Cryogenic -320°F) | All       | All       | \$52.15 per unit<br>+ \$535.00 setup charge per lot |
| **HT  | High temperature (1200°F)          | All       | All       | \$74.70   |
| ***SI | 316 SS interlocking armor          | All       | All       | \$14.85/ft  |
| DP    | Dampened movement                  | All       | All       | \$16.50   |

\* Requires Temperature Range Code "001", See Table 8; \*\* Requires Temperature Range Code "010", See Table 8  
 \*\*\* Required for all systems over 40 feet

| Code | Description | List price |
|------|-------------|------------|
| WI   | WIKA        | N/C        |
| BL   | Blank       | N/C        |

**ABBREVIATIONS**  
 N/C - there is no charge for this option

# GAS ACTUATED THERMOMETERS

Mechanical Temperature > Gas Actuated Thermometers > Ordering Gas Actuated Thermometers

## Type TI.TSG60

Sample Part Number: TSG60 03 2 A2 X7 05 SG WI

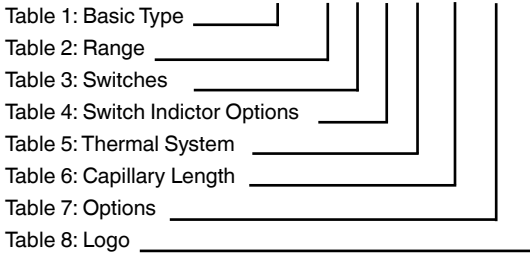

### HOW TO ORDER:

Select the appropriate codes and combine to complete thermometer part number.



| Table 1 - Basic type |  |            |
|----------------------|--|------------|
| Code                 | Description  | List price |
| TSG60                | 6" Back flange temperature switch gauge with conxall connector harness<br>5" wire length | \$1,454.00 |

| Table 2 - Range |             |            |      |             |            |
|-----------------|-------------|------------|------|-------------|------------|
| Code            | Description | List price | Code | Description | List price |
| 01*             | -450/50°F   | \$50.90    | 07   | 0/1000°F    | \$74.70    |
| 02*             | -320/200°F  | \$50.90    | 08   | -20/120°C   | N/C        |
| 03              | 0/250°F     | N/C        | 09   | -20/160°C   | N/C        |
| 04              | -50/350°F   | N/C        | 10   | -20/180°C   | N/C        |
| 05              | 50/550°F    | N/C        | 11   | -20/200°C   | N/C        |
| 06              | 50/750°F    | \$43.50    |      |             |            |

\* Setup charge per lot, refer to price list.

| Table 3 - Switches |  |            |
|--------------------|--|------------|
| Code               | Description                                    | List price |
| 1                  | One adjustable switch (amphenol connector)     | \$87.75    |
| 2                  | Two adjustable switches (amphenol connector)   | \$168.85   |
| 3                  | Three adjustable switches (amphenol connector) | \$401.35   |
| 4                  | Four adjustable switches (amphenol connector)  | \$488.45   |

| Table 4 - Standard switch indicator options |  |
|---|--|
| Code  | Description  |
| A1  | Center switch indicator (1 switch)                     |
| A2  | Right and left switch indicators (2 switches)          |
| A3*   | Right, left and center switch indicators (3 switches)  |
| A4*   | Right, left, right, left switch indicator (4 switches) |

\* For adjacent switches, right and left side indicators will allow for closest proximity of switch settings

| Table 5 - Thermal system |  |            |
|--------------------------|--|------------|
| Code                     | Description  | List price |
| X7                       | 3/8" x 3" bulb w/12" bendable extension,<br>1/2" NPT one-time adjustable compression fitting | \$257.00   |
| X8                       | 3/8" x 3" bulb w/18" bendable extension,<br>1/2" NPT one-time adjustable compression fitting | \$268.00   |

| Table 6 - Capillary length |                          |            |
|----------------------------|--------------------------|------------|
| Code                       | Description              | List price |
| XX                         | Capillary length in feet | \$16.75/ft |

| Table 7 - Options |                 |            |
|-------------------|-----------------|------------|
| Code              | Description     | List price |
| SG                | Safety glass    | \$79.45    |
| EX                | Explosion proof | \$2,024.00 |

| Table 8 - Logo |             |
|----------------|-------------|
| Code           | Description |
| EH WI          | WIKA        |
| EH BL          | Blank       |

ABBREVIATIONS  
N/C - there is no charge for this option

# VAPOR ACTUATED THERMOMETERS

Mechanical Temperature > Vapor Actuated Thermometers > Ordering Vapor Actuated Thermometers

## Type TI.V20 / TI.V25 / TI.V35 / TI.V45

Sample Model No: V25 UB3 5331 05 04 WI

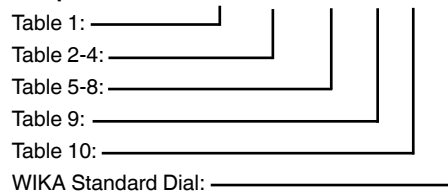

### HOW TO ORDER:

Select the appropriate codes and combine to complete thermometer part number.



| Code | Description | List price |
|------|-------------|------------|
| V20  | 2"          | \$36.75    |
| V25  | 2½"         | \$42.90    |
| V35  | 3½"         | \$58.25    |
| V45  | 4½"         | \$71.40    |

| Code | Case type                | Material | Case size | Case conn. | List price |
|------|--------------------------|----------|-----------|------------|------------|
| F    | Front flange             | SS       | 2", 2½"   | B          | N/C        |
| U    | U-clamp                  | SS       | 2", 2½"   | B          | \$4.15     |
| Q    | U-clamp                  | SS       | 3½"       | B          | \$5.00     |
| B    | Back flange              | SS       | 3½", 4½"  | B, L       | \$30.60    |
| R    | Front flange, semi-flush | SS       | 3½", 4½"  | B          | \$15.35    |

| Code | Description      | Case size | Type | List price |
|------|------------------|-----------|------|------------|
| B    | Back connection  | All       | All  | N/C        |
| L    | Lower connection | 3½", 4½"  | B    | N/C        |

| Code | Description                                | Case size | Case type | List price |
|------|--|-----------|-----------|------------|
| 3    | Lexan® snap-in lens                        | All       | All       | N/C        |
| 4    | Glass lens w/ SS ring                      | 2", 2½"   | F, U      | \$20.50    |
| 5    | Glass lens w/ chrome-plated brass ring     | 3½"       | All       | \$25.60    |
| 7    | Glass lens w/ rubber ring                  | 4½"       | B, R      | \$25.60    |
| 8    | Glass lens w/ crimped SS ring, water-proof | 2", 2½"   | U         | \$18.40    |
| 9    | Lexan® threaded lens                       | 2" 2½"    | F, U, Q   | \$7.65     |

| Code | Bulb type | Bulb mat'l | Capillary mat'l | Cap protection  | List price | Per add'l ft |
|------|-----------|------------|-----------------|-----------------|------------|--------------|
| 1    | Plain     | Copper     | Copper          | None            | \$21.50    | \$2.60       |
| 2    | Plain     | Copper     | Copper          | Cu. braid       | \$24.45    | \$4.00       |
| 3    | Plain     | 316 SS     | 316 SS          | None            | \$53.10    | \$9.00       |
| 4    | Union     | Copper     | Copper          | None            | \$24.45    | \$2.60       |
| 5    | Union     | Copper     | Copper          | Cu. braid       | \$25.60    | \$4.00       |
| 8    | Union     | 316 SS     | 316 SS          | Interlock armor | \$74.55    | \$14.05      |
| 9    | Union     | 316 SS     | 316 SS          | None            | \$65.35    | \$9.00       |

### ABBREVIATIONS

N/C - there is no charge for this option

# VAPOR THERMOMETERS

Mechanical Temperature > Vapor Actuated Thermometers > Ordering Vapor Actuated Thermometers

## Type TI.V20 / TI.V25 / TI.V35 / TI.V45 continued

| Table 6 - Bulb selection  |          |        |                  |            |
|---|----------|--------|------------------|------------|
| Use codes below for plain bulb for non-threaded process connection (Codes 1-3 in Table 5) |          |        |                  |            |
| Code  | Diameter | Length | Max. sys. length | List price |
| 2   | 3/8"     | 3.4"   | 25 feet          | N/C        |
| 3   | 3/8"     | 4.9"   | 50 feet          | \$21.95    |
| 4   | 3/8"     | 7.9"   | 99 feet          | \$33.75    |
| 5   | 3/8"     | 9.4"   | 99 feet          | \$48.05    |
| 6   | 3/8"     | 2.5"   | 5 feet           | N/C        |
| Use codes below for union bulb for threaded process connection (Codes 4-9 in Table 5)     |          |        |                  |            |
| 1   | 7/16"    | 2.5"   | 10 Feet          | N/C        |
| 2   | 7/16"    | 3.4"   | 25 feet          | N/C        |
| 3 <sup>1</sup>  | 7/16"    | 5.4"   | 50 feet          | \$21.95    |
| 4   | 7/16"    | 7.4"   | 99 feet          | \$33.75    |
| 5   | 7/16"    | 9.4"   | 99 feet          | \$48.05    |

<sup>1</sup> Required for lagging extension thermowell, see Table 7

**Note: Available combinations for Thermal System (Table 5) and Bulb Selection (Table 6):**  
**Plain: 12, 13, 14, 15, 16, 22, 23, 24, 25, 26, 32, 33, 34, 35, 36**  
  
**Union: 41, 42, 43, 44, 45, 51, 52, 53, 54, 55, 81, 82, 83, 84, 85, 91, 92, 93, 94, 95**  
  
**Also must consider Capillary Length (Table 9).**

| Table 7 - Process connection fitting |  |            |
|--------------------------------------|--|------------|
| Code                                 | Description  | List price |
| 1                                    | Union 1/2" NPT   | \$13.95    |
| 2                                    | Union 3/4" NPT   | \$16.35    |
| 3                                    | Thermowell 1/2" NPT  | \$20.50    |
| 4                                    | Thermowell 3/4" NPT  | \$23.55    |
| 5*                                   | Thermowell 1/2" NPT with 2" lag ext.                             | \$46.30    |
| 6*                                   | Thermowell 3/4" NPT with 2" lag ext.                             | \$49.0     |
| 7                                    | Aluminum air duct flange (union only)                            | \$26.10    |
| 9                                    | Plain bulb (always select "plain bulb" - table 5; codes 1, 2, 3) | N/C        |

\* Lag only available with #3 bulb

| Table 8 - Process connection material |  |            |
|---------------------------------------|--|------------|
| Code                                  | Description  | List price |
| 0                                     | None (plain bulb only, always select for Codes 1-3 in Table 5) | N/C        |
| 1                                     | Brass  | N/C        |
| 2                                     | 304 SS   | \$42.30    |
| 3                                     | 316 SS   | \$71.40    |
| 5                                     | Aluminum (air duct flange only)                                | N/C        |

| Table 9 - Capillary length |             |                                  |
|----------------------------|-------------|----------------------------------|
| Code                       | Description | List price                       |
| 05                         | 5 feet      | N/C                              |
| 10                         | 10 feet     | See Table 5 for add'l foot adder |
| 15                         | 15 feet     |                                  |
| 20                         | 20 feet     |                                  |
| 30                         | 30 feet     |                                  |
| 50                         | 50 feet     |                                  |
| 80                         | 80 feet     |                                  |

**Note:**  
 Capillary can be configured to any whole foot, 99' and below. I.E. - 08 = 8' capillary

| Table 10 - Range |               |            |
|------------------|---------------|------------|
| Code             | Description   | List price |
| 01               | -40/60 °F&°C  | N/C        |
| 02               | -40/110 °F&°C | N/C        |
| 03               | -20/100 °F&°C | N/C        |
| 04               | 0/150 °F&°C   | N/C        |
| 05               | 0/180 °F&°C   | N/C        |
| 06               | 20/220 °F&°C  | N/C        |
| 07               | 40/240 °F&°C  | N/C        |
| 08               | 30/300 °F&°C  | N/C        |
| 09               | 100/350 °F&°C | N/C        |
| 11               | 150/450 °F&°C | N/C        |

| Table 11 - Logo |             |            |
|-----------------|-------------|------------|
| Code            | Description | List price |
| WI              | WIKA        | N/C        |
| BL              | Blank       | N/C        |

ABBREVIATIONS  
 N/C - there is no charge for this option

# INDUSTRIAL GLASS THERMOMETERS

Mechanical Temperature > Industrial Glass Thermometers > Ordering Industrial Glass Thermometers

## Type TI.61102 / TI.61104 / TI.62102 / TI.62104

Sample Part No: **6210206 213 P WI**

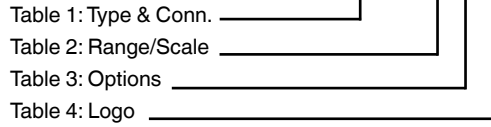

### HOW TO ORDER:

Select the appropriate codes and combine to complete thermometer part number.



| Description           | Stem length | Connection               | Code    | List price |
|-----------------------|-------------|--------------------------|---------|------------|
| Straight with 2" stem | 1.31"       | None-swivel nut          | 6110200 | \$74.80    |
|                       |             | 1/2" and 3/4" brass well | 6110206 | \$87.10    |
| Back with 2" stem     | 1.31"       | None-swivel nut          | 6210200 | \$74.80    |
|                       |             | 1/2" and 3/4" brass well | 6210206 | \$89.45    |
| Straight with 4" stem | 3.31"       | None-swivel nut          | 6110400 | \$112.50   |
|                       |             | 1/2" and 3/4" brass well | 6110406 | \$143.65   |
| Back with 4" stem     | 3.31"       | None-swivel nut          | 6210400 | \$112.50   |
|                       |             | 1/2" and 3/4" brass well | 6210406 | \$147.40   |

| °F only |         |            | °C only |        |            | Dual scale °F & °C |                    |            |
|---------|---------|------------|---------|--------|------------|--------------------|--------------------|------------|
| Code    | °F      | Scale div. | Code    | °C     | Scale div. | Code               | °F & °C            | Scale div. |
| 201     | -40/110 | 2          | 115     | -40/45 | 1          | 001                | -40/110 (-45/45 C) | 2/1        |
| 203     | 20/120  | 2          | 102     | -5/50  | 1          | 003                | 20/120 (0/50 C)    | 2/1        |
| 213     | 20/180  | 2          | 118     | 0/110  | 2          | 013                | 20/180 (0/80 C)    | 2/2        |
| 207     | 30/240  | 2          | 108     | 0/150  | 2          | 007                | 30/240 (5/110 C)   | 2/2        |
| 208     | 30/300  | 5          | 106     | 10/200 | 5          | 008                | 30/300 (0/150 C)   | 5/2        |
| 209     | 50/400  | 5          | n/a     | n/a    | n/a        | 009                | 50/400 (10/200 C)  | 5/5        |

| Code | Description    | List price |
|------|----------------|------------|
| P    | Plastic window | \$7.00     |

| Code | Description | List price |
|------|-------------|------------|
| WI   | WIKA        | N/C        |

ABBREVIATIONS  
N/C - there is no charge for this option.

Replacement 1/2" x 3/4" NPT dual threaded thermowell for 2" stem length only, order part number TA800-6206-BR; list price \$14.00

# INDUSTRIAL GLASS THERMOMETERS

Mechanical Temperature > Industrial Glass Thermometers > Ordering Industrial Glass Thermometers

## Type TI.701 / TI.901

Sample Part No: 901 03 01 004 P WI

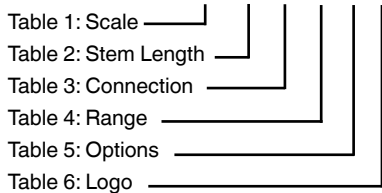

### HOW TO ORDER:

Select the appropriate codes and combine to complete thermometer part number.



| Code | Description                     | List Price |
|------|---------------------------------|------------|
| 701  | 7" scale, swivel-nut connection | \$71.40    |
| 901  | 9" scale, swivel-nut connection | \$71.40    |

| Code | Description | List Price |
|------|-------------|------------|
| 03   | 3½" stem    | \$0.00     |
| 06   | 6" stem     | \$28.85    |
| 09   | 9" stem     | \$88.10    |
| 12   | 12" stem    | \$106.60   |

| Code | Description  | List price             |         |         |          |
|------|--|------------------------|---------|---------|----------|
|      |  | 3½" Stem               | 6" Stem | 9" Stem | 12" Stem |
| 00   | Swivel-nut connection (no thermowell)                | \$0.00                 | \$0.00  | \$0.00  | \$0.00   |
| 01   | ¾" NPT brass, thermowell                             | \$8.30                 | \$8.30  | \$96.70 | \$125.80 |
| 02   | ¾" NPT brass with lagging extension                  | \$8.30                 | \$8.30  | \$96.70 | \$125.80 |
| 03   | ¾" NPT brass union hub                               | <i>Consult factory</i> |         |         |          |
| 04   | Duct flange, reversible with or without lagging ext. | <i>Consult factory</i> |         |         |          |

| Code | °F      | °F Scale div. | Code | °C     | °C Scale div. |
|------|---------|---------------|------|--------|---------------|
| 201  | -40/110 | 2             | 101  | -40/50 | 1             |
| 204  | 0/120   | 1             | 104  | 0/100  | 1             |
| 205  | 0/160   | 2             | 105  | 0/160  | 2             |
| 206  | 30/180  | 2             |      |        |               |
| 207  | 30/240  | 2             |      |        |               |
| 208  | 30/300  | 5             |      |        |               |
| *210 | 50/550  | 5             |      |        |               |

\* Requires aluminum case

| Code | Description   | List price |
|------|---|------------|
| P    | 7" Plastic window                                   | \$7.95     |
| P    | 9" Plastic window                                   | \$9.10     |
| A*   | 7" or 9" aluminum case (required above 300°F/160°C) | \$24.00    |

| Code | Description |
|------|-------------|
| WI   | WIKA        |

| Code | °F      | °C     | °F Scale div. | °C Scale div. |
|------|---------|--------|---------------|---------------|
| 001  | -40/110 | -40/43 | 2             | 1             |
| 004  | 0/120   | -17/49 | 1             | 1             |
| 005  | 0/160   | -15/70 | 2             | 1             |
| 006  | 30/180  | 0/80   | 2             | 1             |
| 007  | 30/240  | 0/115  | 2             | 1             |
| 008  | 30/300  | 0/150  | 5             | 2             |
| *010 | 50/550  | 10/290 | 5             | 5             |

\* Requires aluminum case

MECHANICAL TEMP



# INDUSTRIAL GLASS THERMOMETERS

Mechanical Temperature > Industrial Glass Thermometers > Ordering Industrial Glass Thermometers

## Type TI.701 / TI.901 continued

| Factory stock |   |                 |
|---------------|---|-----------------|
| Part number   | Description   | List price      |
| 9010300004WI  | 9" scale, 3½" stem, 0/120°F & °C                          | <b>\$71.40</b>  |
| 9010300007WI  | 9" scale, 3½" stem, 30/240°F & °C                         | <b>\$71.40</b>  |
| 9010300204WI  | 9" scale, 3½" stem, 0/120°F                               | <b>\$71.40</b>  |
| 9010300205WI  | 9" scale, 3½" stem, 0/160°F                               | <b>\$71.40</b>  |
| 9010300206WI  | 9" scale, 3½" stem, 30/180°F                              | <b>\$71.40</b>  |
| 9010300207WI  | 9" scale, 3½" stem, 30/240°F                              | <b>\$71.40</b>  |
| 9010301204WI  | 9" scale, 3½" stem, with ¾" NPT brass thermowell 0/120°F  | <b>\$79.90</b>  |
| 9010301207WI  | 9" scale, 3½" stem, with ¾" NPT brass thermowell 30/240°F | <b>\$79.90</b>  |
| 9010300005WI  | 9" scale, 3½" stem, 0/160°F & °C                          | <b>\$71.40</b>  |
| 9010600204WI  | 9" scale, 6" stem, 0/120°F                                | <b>\$100.95</b> |
| 9010600208WI  | 9" scale, 6" stem, 30/300°F                               | <b>\$100.95</b> |
| 9010601208WI  | 9" scale, 6" stem, with ¾" NPT brass thermowell 30/300°F  | <b>\$100.95</b> |

| T-85 Thermowell conversion kit |   |                |
|--------------------------------|---|----------------|
| Part number                    | Description   | List price     |
| TA800-0T85                     | This conversion kit offers an easy, inexpensive way to install a WIKA bimetal thermometer in a glass industrial thermometer's thermowell. For more information, please consult factory. | <b>\$30.35</b> |

# SOLAR INDUSTRIAL GLASS THERMOMETERS

Mechanical Temperature > Solar Industrial Glass Thermometers > TI.D01

## Type TI.D01

| Factory stock    |                           |                 |
|------------------|---------------------------|-----------------|
| Part number      | Description               | List price      |
| <b>D010300WI</b> | 3½" Stem, no thermowell   | <b>\$93.80</b>  |
| <b>D010600WI</b> | 6" Stem, no thermowell    | <b>\$105.70</b> |
| <b>D010301WI</b> | 3½" Stem, with thermowell | <b>\$113.30</b> |
| <b>D010601WI</b> | 6" Stem, with thermowell  | <b>\$132.75</b> |

| Non-stocked items |  |            |
|-------------------|--|------------|
| Part number       | Description                                    | List price |
| D010304WI         | 3½" Stem, with reversible flange air duct stem | \$126.05   |
| D010604WI         | 6" Stem, with reversible flange air duct stem  | \$144.35   |
| D010901WI         | 9" Stem with thermowell                        | \$276.15   |

| Accessories |                                |            |
|-------------|--------------------------------|------------|
| Part number | Description                    | List price |
| TA600-0216  | Clear plastic protective cover | \$8.70     |



Factory stocked items shown in **bold print**.

# THERMOWELLS

Mechanical Temperature > Thermowells > Threaded (TH) Connection

## Thermowells Threaded (TH) Configuration

| Model | Type     | Bore Dia. | Lag          | Shank Design      |
|-------|----------|-----------|--------------|-------------------|
| TH2R  | Threaded | 0.260     | No lag       | Stepped (Reduced) |
| TH2S  | Threaded | 0.260     | No lag       | Straight          |
| TH2LR | Threaded | 0.260     | Standard lag | Stepped (Reduced) |
| TH3S  | Threaded | 0.385     | No lag       | Straight          |
| TH3LS | Threaded | 0.385     | Standard lag | Straight          |
| TH2T  | Threaded | 0.260     | No lag       | Tapered           |
| TH2LT | Threaded | 0.260     | Standard lag | Tapered           |
| TH3T  | Threaded | 0.385     | No lag       | Tapered           |
| TH3LT | Threaded | 0.385     | Standard lag | Tapered           |



| Threaded thermowells - special configuration  |       |                  |               |        |        |                             |                              |                              |                                  |
|---|-------|------------------|---------------|--------|--------|-----------------------------|------------------------------|------------------------------|----------------------------------|
| Models TH2 (.260 Bore) and TH3 (.385) bore, tapered, stepped (reduced) or straight shank, with or without lag |       |                  |               |        |        |                             |                              |                              |                                  |
| Process conn.   | Model | No lag<br>U dim. | With lag      |        | S dim. | Brass<br>list price<br>(BR) | 304 SS<br>list price<br>(CC) | 316 SS<br>list price<br>(SS) | Carbon St.<br>list price<br>(CS) |
|   |       |                  | U dim.        | T dim. |        |                             |                              |                              |                                  |
| 50 (1/2")<br>or<br>75 (3/4")  | TH2R  | 015 (1 5/8)      | --            | --     | 2 1/2  | \$52.70                     | \$50.45                      | \$52.70                      | \$45.40                          |
|   | TH2S  | 025 (2 1/2)      | --            | --     | 4      | \$52.70                     | \$50.45                      | \$52.70                      | \$45.40                          |
|   | TH2LR | 045 (4 1/2)      | 025 (2 1/2)   | 2      | 6      | \$111.15                    | \$106.10                     | \$111.15                     | \$95.50                          |
|   | TH3S  | 075 (7 1/2)      | 045 (4 1/2)   | 3      | 9      | \$111.15                    | \$106.10                     | \$111.15                     | \$95.50                          |
|   | TH3LS | 105 (10 1/2)     | 075 (7 1/2)   | 3      | 12     | \$146.40                    | \$139.80                     | \$146.40                     | \$125.80                         |
|   | TH2T  | 135 (13 1/2)     | 105 (10 1/2)  | 3      | 15     |                             | \$206.95                     |                              |                                  |
|   | TH2LT | 165 (16 1/2)     | 135 (13 1/2)  | 3      | 18     |                             | \$197.10                     |                              |                                  |
|   | TH3T  | 225 (22 1/2)     | 195 (19 1/2") | 3      | 24     |                             | \$290.10                     |                              |                                  |
|   | TH3LT |                  |               |        |        |                             |                              |                              |                                  |
| 10 (1")   | TH2R  | 015 (1 5/8)      | --            | --     | 2 1/2  | \$62.80                     | \$60.20                      | \$62.80                      | \$54.20                          |
|   | TH2S  | 025 (2 1/2)      | --            | --     | 4      | \$62.80                     | \$60.20                      | \$62.80                      | \$54.20                          |
|   | TH2LR | 045 (4 1/2)      | 025 (2 1/2)   | 2      | 6      | \$90.90                     | \$86.95                      | \$90.90                      | \$78.30                          |
|   | TH3S  | 075 (7 1/2)      | 045 (4 1/2)   | 3      | 9      | \$132.80                    | \$126.80                     | \$132.80                     | \$114.20                         |
|   | TH3LS | 105 (10 1/2)     | 075 (7 1/2)   | 3      | 12     | \$174.60                    | \$167.10                     | \$174.60                     | \$150.45                         |
|   | TH2T  | 135 (13 1/2)     | 105 (10 1/2)  | 3      | 15     |                             | \$207.15                     |                              |                                  |
|   | TH2LT | 165 (16 1/2)     | 135 (13 1/2)  | 3      | 18     |                             | \$246.50                     |                              |                                  |
|   | TH3T  | 225 (22 1/2)     | 195 (19 1/2") | 3      | 24     |                             | \$290.10                     |                              |                                  |
|   | TH3LT |                  |               |        |        |                             |                              |                              |                                  |

| Accessories                         |             |        |            |
|-------------------------------------|-------------|--------|------------|
| Description                         | Part number | Code   | List price |
| Stainless steel cap and chain       | 50146149    | Code 2 | \$29.65    |
| Stamping on well                    | STAMP       | --     | \$12.30    |
| 5.3 oz. tube heat transfer compound | 2256045     | --     | \$41.70    |
| Stainless steel tag                 | TAG         | --     | \$10.00    |
| Paper tag                           | PTAG        | --     | \$4.00     |

MECHANICAL TEMP

# THERMOWELLS

Mechanical Temperature > Thermowells > Threaded (TH) Connection

## Thermowells Threaded (TH) Configuration

| Accessories                         |             |        |                |
|-------------------------------------|-------------|--------|----------------|
| Description                         | Part number | Code   | List price     |
| Stainless steel cap and chain       |             | Code 2 | <b>\$29.65</b> |
| Stamping on well                    |             | --     | <b>\$12.30</b> |
| 5.3 oz. tube heat transfer compound | 2256045     | --     | <b>\$41.70</b> |
| Stainless steel tag                 | TAG         | --     | <b>\$10.00</b> |
| Paper tag                           | PTAG        | --     | <b>\$4.00</b>  |

| Threaded thermowell<br>factory stock |          |       |       |          |                 |
|--------------------------------------|----------|-------|-------|----------|-----------------|
| Part number                          | Size     | Model | U dim | Material | List price      |
| 50TH2R010BR                          | 1/2" NPT | TH2R  | 1"    | Brass    | <b>\$52.70</b>  |
| 50TH2R010CC                          | 1/2" NPT | TH2R  | 1"    | 304 SS   | <b>\$50.45</b>  |
| 50TH2R010SS                          | 1/2" NPT | TH2R  | 1"    | 316L SS  | <b>\$52.70</b>  |
| 50TH2R025BR                          | 1/2" NPT | TH2R  | 2½"   | Brass    | <b>\$52.70</b>  |
| 50TH2R025CC                          | 1/2" NPT | TH2R  | 2½"   | 304 SS   | <b>\$50.45</b>  |
| 50TH2R025SS                          | 1/2" NPT | TH2R  | 2½"   | 316L SS  | <b>\$52.70</b>  |
| 75TH2R015BR                          | 3/4" NPT | TH2R  | 1⅝"   | Brass    | <b>\$52.70</b>  |
| 75TH2R015CC                          | 3/4" NPT | TH2R  | 1⅝"   | 304 SS   | <b>\$50.45</b>  |
| 75TH2R015SS                          | 3/4" NPT | TH2R  | 1⅝"   | 316L SS  | <b>\$52.70</b>  |
| 75TH2R025BR                          | 3/4" NPT | TH2R  | 2½"   | Brass    | <b>\$52.70</b>  |
| 75TH2R025CC                          | 3/4" NPT | TH2R  | 2½"   | 304 SS   | <b>\$50.45</b>  |
| 75TH2R025SS                          | 3/4" NPT | TH2R  | 2½"   | 316L SS  | <b>\$52.70</b>  |
| 75TH2LR025SS                         | 3/4" NPT | TH2LR | 2½"   | 316L SS  | <b>\$52.70</b>  |
| 75TH2R045BR                          | 3/4" NPT | TH2R  | 4½"   | Brass    | <b>\$111.15</b> |
| 75TH2R045CC                          | 3/4" NPT | TH2R  | 4½"   | 304 SS   | <b>\$106.10</b> |
| 75TH2R045SS                          | 3/4" NPT | TH2R  | 4½"   | 316L SS  | <b>\$111.15</b> |
| 75TH2T045CC                          | 3/4" NPT | TH2R  | 4½"   | 304 SS   | <b>\$106.10</b> |
| 75TH2T045SS                          | 3/4" NPT | TH2R  | 4½"   | 316L SS  | <b>\$76.00</b>  |
| 75TH2LR045SS                         | 3/4" NPT | TH2R  | 4½"   | 316L SS  | <b>\$111.15</b> |
| 75TH2R075CC                          | 3/4" NPT | TH2R  | 7½"   | 304 SS   | <b>\$106.10</b> |
| 75TH2R075SS                          | 3/4" NPT | TH2R  | 7½"   | 316L SS  | <b>\$111.15</b> |

Factory stocked items shown in **bold print**.

# THERMOWELLS

Mechanical Temperature > Thermowells > Flanged (FL) Connection

## Thermowells Flanged (FL) Configuration

| Model | Type    | Bore dia. | Lag    | Shank design |
|-------|---------|-----------|--------|--------------|
| FL2T  | Flanged | 0.260     | No lag | Tapered      |
| FL3T  | Flanged | 0.385     | No lag | Tapered      |

### HOW TO PRICE

Add list price from well selected in Table 1 to list price of flange selected in Table 2.

| Table 1 - Shank type                                      |              |           |        |                                  |                              |                              |
|---|--------------|-----------|--------|----------------------------------|------------------------------|------------------------------|
| Models FL2T and FL3T for flanges up to and including 300# |              |           |        |                                  |                              |                              |
| Size  | Type         | U dim.    | S dim. | Carbon st.<br>list price<br>(CS) | 304 SS<br>list price<br>(CC) | 316 SS<br>list price<br>(SS) |
| 50 (½" NPT)   | FL2T<br>FL3T | 020 (2")  | 4      | \$103.40                         | \$117.05                     | \$121.55                     |
|   |              | 040 (4")  | 6      | \$103.40                         | \$117.05                     | \$121.55                     |
|   |              | 070 (7")  | 9      | \$148.60                         | \$168.70                     | \$175.45                     |
|   |              | 100 (10") | 12     | \$208.80                         | \$237.60                     | \$247.25                     |
|   |              | 130 (13") | 15     | \$261.95                         | \$299.80                     | \$309.75                     |
|   |              | 160 (16") | 18     | \$311.65                         | \$355.75                     | \$370.00                     |
|   |              | 220 (22") | 24     | \$411.05                         | \$469.60                     | \$488.65                     |

| Table 2 - Flange type |                      |                          |                      |                      |
|-----------------------|----------------------|--------------------------|----------------------|----------------------|
| Size                  | Rating<br>and facing | Carbon st.<br>list price | 304 SS<br>list price | 316 SS<br>list price |
| 1"                    | 150# RF or FF        | \$158.00                 | \$204.25             | \$206.80             |
| 1½"                   | 150# RF or FF        | \$186.30                 | \$228.35             | \$236.05             |
| 2"                    | 150# RF or FF        | \$221.50                 | \$276.65             | \$295.70             |
| 1"                    | 150# RTJ             | Consult factory          |                      |                      |
| 1½"                   | 150# RTJ             |                          |                      |                      |
| 2"                    | 150# RTJ             |                          |                      |                      |
| 1"                    | 300# RF or FF        | \$204.10                 | \$244.55             | \$247.80             |
| 1½"                   | 300# RF or FF        | \$220.90                 | \$312.50             | \$319.40             |
| 2"                    | 300# RF or FF        | \$217.20                 | \$351.50             | \$373.10             |
| 1"                    | 300# RTJ             | Consult factory          |                      |                      |
| 1½"                   | 300# RTJ             |                          |                      |                      |
| 2"                    | 300# RTJ             |                          |                      |                      |

Raised face flange supplied as standard ANSI serrated. Specify 125 RMS smooth face if required at no extra charge.

| Accessories                         |             |        |            |
|-------------------------------------|-------------|--------|------------|
| Description                         | Part number | Code   | List price |
| Stainless steel cap and chain       | 50146149    | Code 2 | \$29.65    |
| Stamping on well                    | STAMP       | --     | \$12.30    |
| 5.3 oz. tube heat transfer compound | 2256045     | --     | \$41.70    |
| Stainless steel tag                 | TAG         | --     | \$10.00    |
| Paper tag                           | PTAG        | --     | \$4.00     |

# THERMOWELLS

Mechanical Temperature > Thermowells > Socket/Weld (SW) Connection

## Thermowells Socket/Weld (SW) Connection

| Model | Type        | Bore dia. | Lag          | Shank design |
|-------|-------------|-----------|--------------|--------------|
| SW2R  | Socket weld | 0.260     | No lag       | Stepped      |
| SW2LR | Socket weld | 0.260     | Standard lag | Stepped      |
| SW3S  | Socket weld | 0.385     | No lag       | Straight     |
| SW3LS | Socket weld | 0.385     | Standard lag | Straight     |

### Socket/Weld Thermowells - Special Configuration

SW2 (.260 Bore) and SW3 (.385) bore, stepped and straight shank, with or without lag

| Process conn. | Model                         | No lag<br>U dim. | With lag   |        | S dim. | 304 SS<br>list price<br>(CC) | 316 SS<br>list price<br>(SS) | Carbon st.<br>list price<br>(CS) |
|---------------|-------------------------------|------------------|------------|--------|--------|------------------------------|------------------------------|----------------------------------|
|               |                               |                  | U dim.     | T dim. |        |                              |                              |                                  |
| 75 (¾")       | SW2R<br>SW2LR<br>SW3S<br>SWLS | 025 (2½)         | --         | --     | 4      | \$67.25                      | \$72.30                      | Consult<br>factory               |
|               |                               | 045 (4½)         | 025 (2½)   | 2      | 6      | \$67.25                      | \$72.30                      |                                  |
|               |                               | 075 (7½)         | 045 (4½)   | 3      | 9      | \$98.05                      | \$105.55                     |                                  |
|               |                               | 105 (10½)        | 075 (7½)   | 3      | 12     | \$129.15                     | \$138.90                     |                                  |
|               |                               | 135 (13½)        | 105 (10½)  | 3      | 15     | \$159.95                     | \$172.20                     |                                  |
|               |                               | 165 (16½)        | 135 (13½)  | 3      | 18     | \$191.00                     | \$205.45                     |                                  |
|               |                               | 225 (22½)        | 195 (19½") | 3      | 24     | \$252.90                     | \$272.10                     |                                  |

| Process conn. | Model                         | No lag<br>U dim. | With lag   |        | S dim. | 304 SS<br>list price<br>(CC) | 316 SS<br>list price<br>(SS) | Carbon st.<br>list price<br>(CS) |
|---------------|-------------------------------|------------------|------------|--------|--------|------------------------------|------------------------------|----------------------------------|
|               |                               |                  | U dim.     | T dim. |        |                              |                              |                                  |
| 10 (1")       | SW2R<br>SW2LR<br>SW3S<br>SWLS | 025 (2½)         | --         | --     | 4      | \$77.00                      | \$84.95                      | Consult<br>factory               |
|               |                               | 045 (4½)         | 025 (2½)   | 2      | 6      | \$77.00                      | \$84.95                      |                                  |
|               |                               | 075 (7½)         | 045 (4½)   | 3      | 9      | \$112.55                     | \$124.20                     |                                  |
|               |                               | 105 (10½)        | 075 (7½)   | 3      | 12     | \$148.10                     | \$163.35                     |                                  |
|               |                               | 135 (13½)        | 105 (10½)  | 3      | 15     | \$183.65                     | \$201.15                     |                                  |
|               |                               | 165 (16½)        | 135 (13½)  | 3      | 18     | \$219.20                     | \$241.80                     |                                  |
|               |                               | 225 (22½)        | 195 (19½") | 3      | 24     | \$290.15                     | \$315.10                     |                                  |

### Accessories

| Description                         | Part number | Code   | List price |
|-------------------------------------|-------------|--------|------------|
| Stainless steel cap and chain       | 50146149    | Code 2 | \$29.65    |
| Stamping on well                    | STAMP       | --     | \$12.30    |
| 5.3 oz. tube heat transfer compound | 2256045     | --     | \$41.70    |
| Stainless steel tag                 | TAG         | --     | \$10.00    |
| Paper tag                           | PTAG        | --     | \$4.00     |

MECHANICAL TEMP

# THERMOWELLS

Mechanical Temperature > Thermowells > Sanitary (SC) Configuration

## Thermowells Sanitary (SC) Configuration

| Model | Type     | Bore dia. | Lag          | Shank design |
|-------|----------|-----------|--------------|--------------|
| SC2R  | Sanitary | 0.260     | No lag       | Stepped      |
| SC2LR | Sanitary | 0.260     | Standard lag | Stepped      |
| SC3S  | Sanitary | 0.385     | No lag       | Straight     |
| SC3LS | Sanitary | 0.385     | Standard lag | Straight     |

### Sanitary thermowells - Stepped or straight shank

Type SC2 (.260 Bore) and SC3 (.385) bore, stepped or straight shank, with or without lag

| Process conn.             | Model | No lag<br>U dim. | With lag  |        | S dim. | 304 SS<br>list price<br>(CC) | 316 SS<br>list price<br>(SS) |
|---------------------------|-------|------------------|-----------|--------|--------|------------------------------|------------------------------|
|                           |       |                  | U dim.    | T dim. |        |                              |                              |
| 10 (1")<br>or<br>15 (1½") | SC2R  | 025 (2½)         | --        | --     | 4      | \$272.00                     | \$292.00                     |
|                           |       | 045 (4½)         | 025 (2½") | 2      | 6      | \$312.00                     | \$332.00                     |
|                           | SC2LR | 075 (7½)         | 045 (4½") | 3      | 9      | \$374.00                     | \$392.00                     |
| 20 (2")                   | SC3S  | 025 (2½)         | --        | --     | 4      | \$282.00                     | \$304.00                     |
|                           |       | 045 (4½)         | 025 (2½") | 2      | 6      | \$322.00                     | \$345.00                     |
|                           | SC3LS | 075 (7½)         | 045 (4½") | 3      | 9      | \$381.00                     | \$402.00                     |

| Model | Type     | Bore dia. | Lag          | Shank design |
|-------|----------|-----------|--------------|--------------|
| SC2T  | Sanitary | 0.260     | No lag       | Tapered      |
| SC2LT | Sanitary | 0.260     | Standard lag | Tapered      |
| SC3T  | Sanitary | 0.385     | No lag       | Tapered      |
| SC3LT | Sanitary | 0.385     | Standard lag | Tapered      |

### Sanitary thermowells - Tapered shank

Type SC2 (.260 Bore) and SC3 (.385) bore, tapered shank, with or without lag

| Process conn.             | Model | No lag<br>U dim. | With lag  |        | S dim. | 304 SS<br>list price<br>(CC) | 316 SS<br>list price<br>(SS) |
|---------------------------|-------|------------------|-----------|--------|--------|------------------------------|------------------------------|
|                           |       |                  | U dim.    | T dim. |        |                              |                              |
| 10 (1")<br>or<br>15 (1½") | SC2T  | 025 (2½)         | --        | --     | 4      | \$279.00                     | \$299.00                     |
|                           |       | 045 (4½)         | 025 (2½") | 2      | 6      | \$319.00                     | \$340.00                     |
|                           | SC2LT | 075 (7½)         | 045 (4½") | 3      | 9      | \$381.00                     | \$401.00                     |
| 20 (2")                   | SC3T  | 025 (2½)         | --        | --     | 4      | \$288.00                     | \$312.00                     |
|                           |       | 045 (4½)         | 025 (2½") | 2      | 6      | \$329.00                     | \$336.00                     |
|                           | SC3LT | 075 (7½)         | 045 (4½") | 3      | 9      | \$390.00                     | \$415.00                     |

### Accessories

| Description                         | Part number | Code   | List price |
|-------------------------------------|-------------|--------|------------|
| Stainless steel cap and chain       | 50146149    | Code 2 | \$29.65    |
| Stamping on well                    | STAMP       | --     | \$12.30    |
| 5.3 oz. tube heat transfer compound | 2256045     | --     | \$41.70    |
| Stainless steel tag                 | TAG         | --     | \$10.00    |
| Paper tag                           | PTAG        | --     | \$4.00     |

# THERMOWELLS

Mechanical Temperature > Thermowells > For Industrial Glass Thermometers

## Thermowells For Industrial Glass Thermometers

| Model | Type     | Bore dia. | Lag          | Shank design |
|-------|----------|-----------|--------------|--------------|
| TH5R  | Threaded | 0.435     | No lag       | Stepped      |
| TH5LR | Threaded | 0.435     | Standard lag | Stepped      |

| WIKA industrial thermowell coding explanation |               |          |          |        |                     |                       |                        |                         |
|---|---------------|----------|----------|--------|---------------------|-----------------------|------------------------|-------------------------|
| Model TH5 stepped shank, with or without lag  |               |          |          |        |                     |                       |                        |                         |
| Process conn.                                 | Model         | No lag   | with lag |        | "S"                 | Brass list price (BR) | 304 SS list price (CC) | 316L SS list price (SS) |
|   |               |          | U dim.   | T dim. |                     |                       |                        |                         |
| 75 (3/4")<br>or<br>10 (1")                    | TH5R<br>TH5LR | 2-9/16"  | -----    | -----  | <b>035</b> (3 1/2") | <b>\$73.20</b>        | <b>Consult factory</b> | <b>Consult factory</b>  |
|   |               | 5-1/16"  | 2-9/16"  | 2 1/2" | <b>060</b> (6")     | <b>\$73.20</b>        |                        |                         |
|   |               | 8-1/16"  | 5-1/16"  | 3"     | <b>090</b> (9")     | <b>\$121.95</b>       |                        |                         |
|   |               | 11-1/16" | 8-1/16"  | 3"     | <b>120</b> (12")    | <b>\$150.30</b>       |                        |                         |

| Accessories                         |             |        |                |
|-------------------------------------|-------------|--------|----------------|
| Description                         | Part number | Code   | List price     |
| Stainless steel cap and chain       | 50146149    | Code 2 | <b>\$29.65</b> |
| Stamping on well                    | STAMP       | --     | <b>\$12.30</b> |
| 5.3 oz. tube heat transfer compound | 2256045     | --     | <b>\$41.70</b> |
| Stainless steel tag                 | TAG         | --     | <b>\$10.00</b> |
| Paper tag                           | PTAG        | --     | <b>\$4.00</b>  |

| Factory stock threaded thermowell for ind. glass thermometers |                |
|---|----------------|
| Part number   | List price     |
| <b>75TH5R035BR</b>  | <b>\$15.95</b> |
| <b>75TH5R060BR</b>  | <b>\$25.15</b> |
| <b>75TH5LR035BR</b>   | <b>\$18.75</b> |

Factory stocked items shown in **bold print**.



# ACCESSORIES

Accessories > 910.10, 910.11



| Type                 |              | 910.10  |               |                 |                |                |
|----------------------|--------------|---|---------------|-----------------|----------------|----------------|
| Pressure Gauge Cocks |              |   |               |                 |                |                |
| Material             | Lever type   | Connection  | Press. rating | Max temp rating | Part number    | List price     |
| Brass                | T handle     | ¼" X ¼" NPT female                                | 200 psi       | 140°F           | <b>4339631</b> | <b>\$12.95</b> |
| Brass                | T handle     | ¼" NPT female X ¼" NPT male                       | 200 psi       | 140°F           | <b>4339640</b> | <b>\$12.95</b> |
| Brass                | Lever handle | ¼" X ¼" NPT female                                | 200 psi       | 140°F           | <b>4339658</b> | <b>\$23.30</b> |
| Brass                | Lever handle | ½" X ½" NPT female                                | 200 psi       | 140°F           | <b>4339674</b> | <b>\$40.30</b> |
| Brass                | Lever handle | ¼" NPT female X ¼" NPT male with union connection | 200 psi       | 140°F           | <b>4339666</b> | <b>\$58.60</b> |

NOTE: In applications where process media leakage may result in possible personal injury or property damage, gauge cocks should not be specified as they contain no packing gland and leakage may result. For tight shut-off and prevention of leakage, use of a WIKA Needle Valve is required.

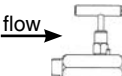

| Type   |                 | 910.11 |                |                 |                |                 |
|--|-----------------|--------|----------------|-----------------|----------------|-----------------|
| Hard Seat or Soft Seat Needle Valves   |                 |        |                |                 |                |                 |
| Connection   | Body material   | Size   | Hard seat      |                 | Soft seat      |                 |
|  |                 |        | Part number    | List price      | Part number    | List price      |
| <br>Female-Female | Carbon steel    | ¼" NPT | <b>9698838</b> | <b>\$43.35</b>  | 9698919        | <b>\$44.45</b>  |
|  |                 | ⅜" NPT | <b>4339925</b> | <b>\$48.30</b>  |                |                 |
|  |                 | ½" NPT | <b>9698846</b> | <b>\$47.10</b>  | <b>9698927</b> | <b>\$47.10</b>  |
|  |                 | ¾" NPT | <b>4339933</b> | <b>\$119.55</b> |                |                 |
|  | Stainless steel | ¼" NPT | <b>9698855</b> | <b>\$97.35</b>  | <b>9698935</b> | <b>\$96.60</b>  |
|  |                 | ⅜" NPT | <b>4339941</b> | <b>\$142.60</b> |                |                 |
| <br>Male-Female   | Carbon steel    | ¼" NPT | <b>9698871</b> | <b>\$47.10</b>  | <b>9698952</b> | <b>\$49.50</b>  |
|  |                 | ½" NPT | <b>9698889</b> | <b>\$53.35</b>  | <b>9698960</b> | <b>\$53.35</b>  |
|  | Stainless steel | ¼" NPT | <b>9698897</b> | <b>\$122.55</b> | <b>9698978</b> | <b>\$122.95</b> |
|  |                 | ½" NPT | <b>9698901</b> | <b>\$133.65</b> | <b>9698986</b> | <b>\$133.65</b> |





| Type   |                 | 910.11 |                |                 |
|--|-----------------|--------|----------------|-----------------|
| Hard Seat 90° Angle Needle Valves  |                 |        |                |                 |
| Connection   | Body material   | Size   | Part number    | List price      |
| <br>Female-Female | Carbon steel    | ¼" NPT | <b>9799295</b> | <b>\$61.20</b>  |
|  |                 | ½" NPT | 9799308        | <b>\$64.20</b>  |
|  | Stainless steel | ¼" NPT | 9799316        | <b>\$141.05</b> |
|  |                 | ½" NPT | <b>9799325</b> | <b>\$169.75</b> |
| <br>Male-Female   | Carbon steel    | ¼" NPT | <b>9799333</b> | <b>\$61.20</b>  |
|  |                 | ½" NPT | 9799341        | <b>\$64.20</b>  |
|  | Stainless steel | ¼" NPT | <b>9799359</b> | <b>\$145.30</b> |
|  |                 | ½" NPT | <b>9799367</b> | <b>\$174.75</b> |

Note: Stock items shown in bold print.

# ACCESSORIES

Accessories > 910.11.100, 910.11.200, 910.11.300

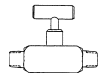
| Type   |                 | 910.11.100         |                |                |  |
|--|-----------------|--------------------|----------------|----------------|--|
|  |                 | Mini Needle Valves |                |                |  |
| Connection   | Body material   | Size               | Part number    | List price     |  |
| Female-Female<br>         | Brass           | 1/8" NPT           | 4266120        | <b>\$34.10</b> |  |
|  |                 | 1/4" NPT           | <b>4266138</b> | <b>\$34.10</b> |  |
|  | Carbon steel    | 1/8" NPT           | 4266146        | <b>\$34.90</b> |  |
|  |                 | 1/4" NPT           | <b>4266154</b> | <b>\$34.90</b> |  |
|  | Stainless steel | 1/8" NPT           | 4266162        | <b>\$84.40</b> |  |
|  |                 | 1/4" NPT           | <b>4266171</b> | <b>\$84.40</b> |  |
| Male-Female<br>flow →<br> | Brass           | 1/8" NPT           | 4266189        | <b>\$34.10</b> |  |
|  |                 | 1/4" NPT           | <b>4266197</b> | <b>\$34.10</b> |  |
|  | Carbon steel    | 1/8" NPT           | 4266201        | <b>\$34.90</b> |  |
|  |                 | 1/4" NPT           | <b>4266219</b> | <b>\$34.90</b> |  |
|  | Stainless steel | 1/8" NPT           | 4266227        | <b>\$84.40</b> |  |
|  |                 | 1/4" NPT           | <b>4266235</b> | <b>\$84.40</b> |  |
| Male-Male<br>             | Brass           | 1/8" NPT           | 4266243        | <b>\$34.10</b> |  |
|  |                 | 1/4" NPT           | 4266251        | <b>\$34.10</b> |  |
|  | Carbon steel    | 1/8" NPT           | 4266260        | <b>\$34.90</b> |  |
|  |                 | 1/4" NPT           | 4266278        | <b>\$34.90</b> |  |
|  | Stainless steel | 1/8" NPT           | 4266286        | <b>\$84.40</b> |  |
|  |                 | 1/4" NPT           | <b>4266294</b> | <b>\$84.40</b> |  |







Brass mini-valves supplied with knurled knob standard.



Carbon steel and stainless steel mini-valves supplied with T-handle.

Note: Stock items shown in bold print.

| Type   |           | 910.11.200                  |          |                |                 |  |
|--|-----------|-----------------------------|----------|----------------|-----------------|--|
|  |           | Block & Bleed Needle Valves |          |                |                 |  |
| Connection   | Seat      | Body material               | Size     | Part number    | List price      |  |
| Female-Female<br>         | Hard seat | Carbon steel                | 1/4" NPT | 4339682        | <b>\$75.35</b>  |  |
|  |           |                             | 1/2" NPT | <b>4339691</b> | <b>\$78.15</b>  |  |
|  |           | Stainless steel             | 1/4" NPT | <b>4339704</b> | <b>\$151.15</b> |  |
|  |           |                             | 1/2" NPT | <b>4339712</b> | <b>\$172.35</b> |  |
| Male-Female<br>flow →<br> |           | Carbon steel                | 1/4" NPT | 4339721        | <b>\$80.20</b>  |  |
|  |           |                             | 1/2" NPT | <b>4339739</b> | <b>\$84.80</b>  |  |
|  |           | Stainless steel             | 1/4" NPT | <b>4339747</b> | <b>\$180.15</b> |  |
|  |           |                             | 1/2" NPT | <b>4339755</b> | <b>\$192.25</b> |  |
| Female-Female<br>         | Soft seat | Carbon steel                | 1/4" NPT | 4339763        | <b>\$75.35</b>  |  |
|  |           |                             | 1/2" NPT | 4339771        | <b>\$80.40</b>  |  |
|  |           | Stainless steel             | 1/4" NPT | 4339780        | <b>\$152.45</b> |  |
|  |           |                             | 1/2" NPT | <b>4339798</b> | <b>\$163.90</b> |  |
| Male-Female<br>flow →<br> |           | Carbon steel                | 1/4" NPT | 4339801        | <b>\$81.35</b>  |  |
|  |           |                             | 1/2" NPT | <b>4339810</b> | <b>\$86.10</b>  |  |
|  |           | Stainless steel             | 1/4" NPT | <b>4339828</b> | <b>\$181.50</b> |  |
|  |           |                             | 1/2" NPT | <b>4339836</b> | <b>\$194.90</b> |  |



| Type   |           | 910.11.300               |                             |                |                 |  |
|--|-----------|--------------------------|-----------------------------|----------------|-----------------|--|
|  |           | Multi-Port Needle Valves |                             |                |                 |  |
| Connection   | Seat      | Body material            | Size                        | Part number    | List price      |  |
| Male-Female<br>flow →<br> | Hard seat | Carbon steel             | 1/2" NPT                    | <b>4339844</b> | <b>\$98.45</b>  |  |
|  |           |                          | 3/4" male X 1/2" female NPT | 4339852        | <b>\$101.95</b> |  |
|  |           | Stainless steel          | 1/2" NPT                    | <b>4339861</b> | <b>\$207.75</b> |  |
|  |           |                          | 3/4" male X 1/2" female NPT | 4339879        | <b>\$220.85</b> |  |
|  | Soft seat | Carbon steel             | 1/2" NPT                    | <b>4339887</b> | <b>\$80.65</b>  |  |
|  |           |                          | 3/4" male X 1/2" female NPT | 4339895        | <b>\$84.95</b>  |  |
|  |           | Stainless steel          | 1/2" NPT                    | <b>4339909</b> | <b>\$164.65</b> |  |
|  |           |                          | 3/4" male X 1/2" female NPT | <b>4339917</b> | <b>\$177.80</b> |  |



# ACCESSORIES

Accessories > 910.12.100, 910.12.200, 910.12.300

| Type             | 910.12.100<br>Porous Snubbers |             |                 |                 |                |
|------------------|-------------------------------|-------------|-----------------|-----------------|----------------|
| Application      | Material                      | Connection  | Pressure rating | Part number     | List price     |
| Air, steam, gas  | Brass                         | ¼" M x ¼" F | 5,000 psi       | <b>4341503</b>  | <b>\$9.80</b>  |
| Light oil, water | Brass                         | ¼" M x ¼" F | 5,000 psi       | <b>4341511</b>  | <b>\$9.80</b>  |
| Air, steam, gas  | SS                            | ¼" M x ¼" F | 15,000 psi      | <b>4001524</b>  | <b>\$35.00</b> |
| Air, steam, gas  | Brass                         | ½" M x ½" F | 5,000 psi       | <b>50409671</b> | <b>\$56.40</b> |
| Air, steam, gas  | SS                            | ½" M x ½" F | 15,000 psi      | <b>50409662</b> | <b>\$95.85</b> |



910.12.100

| Type     | 910.12.200<br>Piston Snubbers <sup>1</sup> |                 |                |                 |
|----------|--|-----------------|----------------|-----------------|
| Material | Connection                                 | Pressure rating | Part number    | List price      |
| Brass    | ¼" NPT                                     | 5,000 psi       | 4201639        | <b>\$65.00</b>  |
|          | ½" NPT                                     | 5,000 psi       | <b>4201647</b> | <b>\$75.00</b>  |
| 316 SS   | ¼" NPT                                     | 15,000 psi      | 4201655        | <b>\$145.00</b> |
|          | ½" NPT                                     | 15,000 psi      | <b>4201663</b> | <b>\$155.00</b> |



910.12.200



<sup>1</sup> Supplied with five pistons for light to heavy snubbing

| Type     | 910.12.300<br>Throttling Snubbers <sup>2</sup> |                 |                 |                 |
|----------|--|-----------------|-----------------|-----------------|
| Material | Connection                                     | Pressure rating | Part number     | List price      |
| Brass    | ¼" NPT   | 3,400 psi       | <b>50334603</b> | <b>\$95.00</b>  |
|          | ½" NPT   | 3,400 psi       | <b>50334611</b> | <b>\$105.00</b> |
| 316 SS   | ¼" NPT   | 5,800 psi       | <b>50334620</b> | <b>\$125.00</b> |
|          | ½" NPT   | 5,800 psi       | <b>50334638</b> | <b>\$135.00</b> |



910.12.300

<sup>2</sup> Includes a stainless steel needle valve

**Note:** Stock items shown in **bold print**.

# ACCESSORIES

Accessories > 910.13, 910.14.100, 910.14.200, 910.14.300

| Type                                 |             | 910.13                  |                 |
|--------------------------------------|-------------|-------------------------|-----------------|
|                                      |             | Over-pressure Protector |                 |
| Range (psi)                          | Range (bar) | Part number             | List price      |
| 6 to 35                              | 0.4 to 2.5  | <b>9091963</b>          | <b>\$467.00</b> |
| 30 to 85                             | 2 to 6      | <b>9091971</b>          | <b>\$436.00</b> |
| 85 to 365                            | 5 to 25     | <b>9091980</b>          | <b>\$436.00</b> |
| 290 to 870                           | 20 to 60    | <b>0690600</b>          | <b>\$436.00</b> |
| 725 to 3,625                         | 50 to 250   | <b>0690619</b>          | <b>\$436.00</b> |
| 3,500 to 5,800                       | 240 to 400  | <b>1615130</b>          | <b>\$436.00</b> |
| 5,800 to 8,700                       | 400 to 600  | <b>50311115</b>         | <b>\$479.00</b> |
| Factory set over-pressure protectors |             |                         |                 |
| 6 to 35                              | 0.4 to 2.5  | <b>50681222</b>         | <b>\$568.00</b> |
| 30 to 85                             | 2 to 6      | <b>50681231</b>         | <b>\$538.00</b> |
| 85 to 365                            | 5 to 25     | <b>50681249</b>         | <b>\$538.00</b> |
| 290 to 870                           | 20 to 60    | <b>50681257</b>         | <b>\$538.00</b> |
| 725 to 3,625                         | 50 to 250   | <b>50681265</b>         | <b>\$538.00</b> |
| 3,500 to 5,800                       | 240 to 400  | <b>50681273</b>         | <b>\$538.00</b> |
| 5,800 to 8,700                       | 400 to 600  | <b>50681281</b>         | <b>\$582.00</b> |

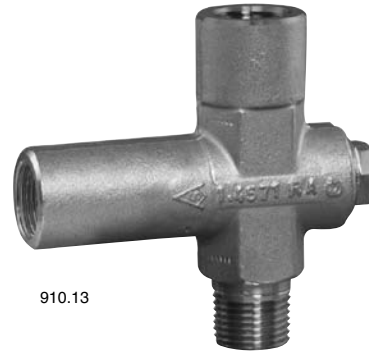

910.13

| Type     |             | 910.14.100      |           |                  |             |               |
|----------|-------------|-----------------|-----------|------------------|-------------|---------------|
|          |             | Test Port Plugs |           |                  |             |               |
| Material | Connection  | Pressure rating | Plug core | Max. temp rating | Part number | List price    |
| Brass    | ¼" NPT male | 1,000 psi       | neoprene  | 200°F            | 4339950     | <b>\$8.00</b> |
| Brass    | ½" NPT male | 1,000 psi       | neoprene  | 200°F            | 4339968     | <b>\$9.95</b> |
| Brass    | ¼" NPT male | 1,000 psi       | nordel    | 350°F            | 4343591     | <b>\$8.00</b> |
| Brass    | ½" NPT male | 1,000 psi       | nordel    | 350°F            | 4343603     | <b>\$8.80</b> |

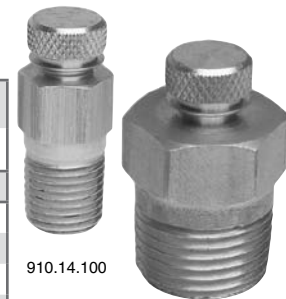

910.14.100

| Type            |                            | 910.14.200             |                |
|-----------------|----------------------------|------------------------|----------------|
|                 |                            | NPT to Metric Adaptors |                |
| Material        | Description                | Part number            | List price     |
| Brass           | ¼" NPT female to G¼ B male | 0084514                | <b>\$41.80</b> |
| Brass           | ½" NPT female to G½ B male | 0187143                | <b>\$41.80</b> |
| Stainless steel | ¼" NPT female to G¼ B male | 1247573                | <b>\$99.80</b> |
| Stainless steel | ½" NPT female to G½ B male | 0634603                | <b>\$99.80</b> |



910.14.200

| Type                  |                 | 910.14.300              |                 |  |
|-----------------------|-----------------|-------------------------|-----------------|--|
|                       |                 | Couplings (for siphons) |                 |  |
| Connection            | Body material   | Part number             | List price      |  |
| ¼" X ¼"<br>NPT female | Brass           | 1652974                 | <b>\$26.45</b>  |  |
|                       | Steel           | 1652982                 | <b>\$26.25</b>  |  |
|                       | Stainless steel | 1652990                 | <b>\$48.65</b>  |  |
| ½" X ½"<br>NPT female | Brass           | 1653008                 | <b>\$44.25</b>  |  |
|                       | Steel           | 1653016                 | <b>\$31.60</b>  |  |
|                       | Stainless steel | 1653024                 | <b>\$90.60</b>  |  |
|                       | Chr. moly       | 1601040                 | <b>\$188.40</b> |  |



910.14.300

Note: Stock items shown in bold print.

# ACCESSORIES

Accessories > 910.24, 910.15.100

| Type            |            | 910.24<br>Mini-Siphon |              |                 |                 |
|-----------------|------------|-----------------------|--------------|-----------------|-----------------|
| Body material   | Conn. size | Pressure rating       | Temp. rating | Part number     | List price      |
| Stainless steel | 1/2" NPT   | 6,164 PSI             | 840 °F       | <b>50673670</b> | <b>\$191.90</b> |

| Type  |                | 910.15.100<br>Pigtail Siphon |               |              |                |                 |
|---|----------------|------------------------------|---------------|--------------|----------------|-----------------|
| Siphon form   | Body material  | Size                         | Press. rating | Temp. rating | Part number    | List price      |
|  | Brass          | 1/4" NPT                     | 250 psi       | 400 °F       | <b>4201779</b> | <b>\$30.60</b>  |
|   | Steel, Sch 40  | 1/4" NPT                     | 500 psi       | 400 °F       | <b>4201787</b> | <b>\$14.75</b>  |
|   | 316 SS, Sch 40 | 1/4" NPT                     | 500 psi       | 400 °F       | <b>4201761</b> | <b>\$180.15</b> |
|   | 316 SS, Sch 80 | 1/2" NPT                     | 2,600 psi     | 500 °F       | <b>4362719</b> | <b>\$227.05</b> |

| Type  |                 | 910.15.200<br>Coil Siphon |               |              |                |                 |
|---|-----------------|---------------------------|---------------|--------------|----------------|-----------------|
| Siphon form   | Body material   | Size                      | Press. rating | Temp. rating | Part number    | List price      |
|  | Brass           | 1/4" NPT                  | 250 psi       | 400 °F       | 4201809        | <b>\$50.75</b>  |
|   | Steel, sch 40   | 1/4" NPT                  | 500 psi       | 400 °F       | <b>4201817</b> | <b>\$20.15</b>  |
|   | Steel, sch 80   | 1/4" NPT                  | 3,360 psi     | 400 °F       | <b>4201825</b> | <b>\$57.55</b>  |
|   | Steel, sch 80   | 1/2" NPT                  | 3,000 psi     | 400 °F       | <b>4201833</b> | <b>\$130.70</b> |
|   | Steel, sch 160  | 1/2" NPT                  | 3,620 psi     | 700 °F       | <b>4201841</b> | <b>\$140.00</b> |
|   | 316 SS, sch 80  | 1/2" NPT                  | 2,650 psi     | 500 °F       | <b>4201850</b> | <b>\$415.60</b> |
|   | 316 SS, sch 160 | 1/2" NPT                  | 5,600 psi     | 500 °F       | <b>4201795</b> | <b>\$588.05</b> |
|   | Chr. moly       | 1/2" NPT                  | 8,205 psi     | 750 °F       | 4201868        | <b>\$396.30</b> |

**Note:** Stock items shown in **bold print**.



# ACCESSORIES

Accessories > CP3000, CP4000, 904.XX

| Type  |                     | CP3000   |                 |                 |                 |
|---|---------------------|--|-----------------|-----------------|-----------------|
|   |                     | Magnetically Assisted Alarm Contacts<br>for 4½" Process Gauges |                 |                 |                 |
| Contact type                                | Contact arrangement | Installed <sup>1</sup>   |                 | Sold separately |                 |
|   |                     | Part number  | List price      | Part number     | List price      |
| 828.1                                       | N.O.                | 828.1  | <b>\$460.00</b> | 774901          | <b>\$420.00</b> |
| 828.2                                       | N.C.                | 828.2  | <b>\$460.00</b> | 774910          | <b>\$420.00</b> |
| 828.11                                      | N.O./N.O.           | 828.11   | <b>\$555.00</b> | 774928          | <b>\$515.00</b> |
| 828.12                                      | N.O./N.C.           | 828.12   | <b>\$555.00</b> | 691178          | <b>\$515.00</b> |
| 828.21                                      | N.C./N.O.           | 828.21   | <b>\$555.00</b> | 691186          | <b>\$515.00</b> |
| 828.22                                      | N.C./N.C.           | 828.22   | <b>\$555.00</b> | 774936          | <b>\$515.00</b> |
| Adder to remove Triacs for DC Service       |                     | NO TRIAC   | <b>\$20.30</b>  |                 |                 |
| Silicone fill (installed only) <sup>2</sup> |                     | SIL  | <b>\$82.90</b>  |                 |                 |



CP3000 / CP4000

<sup>1</sup> Does not include price of the process gauge; <sup>2</sup> For Lower Back Mount (LBM) - add \$13.80 List Each

NOTE: Gauge accuracy changes from 0.5% to 1.0% of Full Span when contact assembly is installed.

| Type                                       |                     | CP4000   |                 |                 |                  |
|--|---------------------|--|-----------------|-----------------|------------------|
|  |                     | Inductive Proximity Alarm Contacts<br>for 4½" Process Gauges |                 |                 |                  |
| Contact type                               | Contact arrangement | Installed <sup>1</sup>                                       |                 | Sold separately |                  |
|  |                     | Part number  | List price      | Part number     | List price       |
| 838.1                                      | N.O.                | 838.1  | <b>\$560.00</b> | 771775          | <b>\$520.00</b>  |
| 838.2                                      | N.C.                | 838.2  | <b>\$560.00</b> | 1193368         | <b>\$520.00</b>  |
| 838.11                                     | N.O./N.O.           | 838.11   | <b>\$650.00</b> | 771791          | <b>\$610.00</b>  |
| 838.12                                     | N.O./N.C.           | 838.12   | <b>\$650.00</b> | 1193376         | <b>\$610.00</b>  |
| 838.21                                     | N.C./N.O.           | 838.21   | <b>\$650.00</b> | 1193384         | <b>\$610.00</b>  |
| 838.22                                     | N.C./N.C.           | 838.22   | <b>\$650.00</b> | 1193392         | <b>\$610.00</b>  |
| Permanently attach reset knob <sup>2</sup> |                     |  |                 | 2069334         | <b>No charge</b> |

<sup>1</sup> Does not include price of the process gauge; <sup>2</sup> Reset Key Knob P/N0018147 (sold separately - **\$2.60** List Each)

NOTE: Intrinsically Safe (Type SN) with Fail/Safe Control is available as a special order option.

Gauge accuracy changes from 0.5% to 1.0% of Full Span when contact assembly is installed.

| Type                    |        | 904.XX   |                             |             |                   |
|-------------------------|--------|--|-----------------------------|-------------|-------------------|
|                         |        | Control Units for Inductive Proximity Alarm Contacts |                             |             |                   |
| Contact rating          | Type   | Use  | For use with                | Part number | List price        |
| 220 VAC, 5A,<br>1100 VA | 904.25 | General use  | Single contacts Type 838.X  | 1195298     | <b>\$285.00</b>   |
|                         | 904.26 | General use  | Double contacts Type 838.XX | 1195310     | <b>\$350.00</b>   |
| 250 VAC, 4A,<br>500 VA  | 904.15 | Intrinsically safe <sup>1</sup>                      | Single contacts Type 838.X  | 2367446     | <b>\$755.00</b>   |
|                         | 904.16 | Intrinsically safe <sup>1</sup>                      | Double contacts Type 838.XX | 2314762     | <b>\$840.00</b>   |
|                         | 904.17 | Intrinsically safe <sup>1</sup>                      | Fail safe (for one contact) | 2014548     | <b>\$1,920.00</b> |

<sup>1</sup> Intrinsically Safe (FM Approved)

Abbreviations

N.O. - Normally Open

N.C. - Normally Closed

**Note:** Stock items shown in **bold print**.

ACCESSORIES

# ACCESSORIES

Accessories > Pressure Gauge Accessories

## Pressure Gauge Accessories

| Certificate of Compliance  | "ORDER CODE" | Charge per line item or per gauge | Price                      |
|--|--------------|-----------------------------------|----------------------------|
| Certificate of Compliance (Standard)   | CoC-01       | per Line Item                     | No Charge                  |
| Gauge Accuracy (ASME B40.1 Grade 2A) Certificate of Compliance               | CoC-02       | per Line Item                     | No Charge                  |
| Gauge Accuracy (ASME B40.1 Grade 1A) Certificate of Compliance               | CoC-03       | per Line Item                     | No Charge                  |
| Gauge Accuracy (ASME B40.1 Grade A) Certificate of Compliance                | CoC-04       | per Line Item                     | No Charge                  |
| Gauge Accuracy (ASME B40.1 Grade B) Certificate of Compliance                | CoC-05       | per Line Item                     | No Charge                  |
| Bi-Metal Certificate of Compliance   | CoC-06       | per Line Item                     | No Charge                  |
| Bi-Metal Accuracy Certificate of Compliance                                  | CoC-07       | per Line Item                     | No Charge                  |
| Cleanliness Level IV ONLY Certificate of Compliance                          | CoC-08       | per Line Item                     | No Charge                  |
| Ingress Protection Rating (IP54) Certificate of Compliance                   | CoC-09       | per Line Item                     | No Charge                  |
| Ingress Protection Rating (IP65) Certificate of Compliance                   | CoC-10       | per Line Item                     | No Charge                  |
| Ingress Protection Rating (IP66) Certificate of Compliance                   | CoC-11       | per Line Item                     | No Charge                  |
| Ingress Protection Rating (IP67) Certificate of Compliance                   | CoC-12       | per Line Item                     | No Charge                  |
| Ingress Protection Rating (IP68) Certificate of Compliance                   | CoC-13       | per Line Item                     | No Charge                  |
| Material (SS) Certificate of Compliance                                      | CoC-14       | per Line Item                     | No Charge                  |
| Material (Monel®) Certificate of Compliance                                  | CoC-15       | per Line Item                     | No Charge                  |
| Mercury Free Certificate of Compliance                                       | CoC-16       | per Line Item                     | No Charge                  |
| Drinking Water System Components Certificate of Compliance                   | CoC-17       | per Line Item                     | No Charge                  |
| Sanitary Gauge Certificate of Compliance                                     | CoC-18       | per Line Item                     | No Charge                  |
| Ultra High Purity Certificate of Compliance                                  | CoC-19       | per Line Item                     | No Charge                  |
| Inspection Certificate 2.2   | "ORDER CODE" | Charge per line item or per gauge | NET Price                  |
| Certificate of Pressure & Stability (Pressure Test Up to Overpressure Limit) | 2.2-DK       | per Line Item                     | \$25.00 Net / \$40.00 Net* |
| Certificate of Class and Accuracy  | 2.2-F1       | per Line Item                     | \$25.00 Net / \$40.00 Net* |
| Certificate of Oxygen Cleanliness to ASME B40.100 Level IV                   | 2.2-S0       | per Line Item                     | \$25.00 Net / \$40.00 Net* |
| Certificate of Silicone Free Product   | 2.2-S1       | per Line Item                     | \$25.00 Net / \$40.00 Net* |
| Certificate of FDA-Conform Filling-Fluid                                     | 2.2-S2       | per Line Item                     | \$25.00 Net / \$40.00 Net* |
| Certificate of Weather Protection to IP65                                    | 2.2-S3       | per Line Item                     | \$25.00 Net / \$40.00 Net* |
| Certificate of Weather Protection to IP66                                    | 2.2-IP66     | per Line Item                     | \$25.00 Net / \$40.00 Net* |
| Certificate of Weather Protection to IP67                                    | 2.2-IP67     | per Line Item                     | \$25.00 Net / \$40.00 Net* |
| Certificate of Weather Protection to IP68                                    | 2.2-IP68     | per Line Item                     | \$25.00 Net / \$40.00 Net* |
| Certificate of Surface Roughness of Diaphragm Ra < 0.5µm                     | 2.2-S4       | per Line Item                     | \$25.00 Net / \$40.00 Net* |
| Certificate of Zone 0 flame proof throttle according ATEX                    | 2.2-S5       | per Line Item                     | \$25.00 Net / \$40.00 Net* |
| Certificate of Leak Testing (10-9)   | 2.2-S6       | per Line Item                     | \$25.00 Net / \$40.00 Net* |
| Certificate of Leak Testing (10-7)   | 2.2-10/7     | per Line Item                     | \$25.00 Net / \$40.00 Net* |
| Certificate of Leak Testing (10-6)   | 2.2-10/6     | per Line Item                     | \$25.00 Net / \$40.00 Net* |
| Certificate of Leak Testing (10-4)   | 2.2-10/4     | per Line Item                     | \$25.00 Net / \$40.00 Net* |
| Certificate of 3-A Approval  | 2.2-S7       | per Line Item                     | \$25.00 Net / \$40.00 Net* |
| Confirmation EHEDG Certification   | 2.2-S8       | per Line Item                     | \$25.00 Net / \$40.00 Net* |
| Certificate of Manufacturing According to State of the Art                   | 2.2-K1       | per Line Item                     | \$25.00 Net / \$40.00 Net* |
| Material Certificate: SS wetted parts material (metal contents)              | 2.2-A1       | per Line Item                     | \$25.00 Net / \$40.00 Net* |
| Material Certificate: Monel® wetted parts material (metal contents)          | 2.2-MMO      | per Line Item                     | \$25.00 Net / \$40.00 Net* |

\* \$25 net charge when purchased at the same time as the item(s) being certified. \$40 net charge for certificates issued after shipment of the item(s) being certified.

For datasheets and additional information, please visit [www.wika.com](http://www.wika.com) or call 1-888-945-2872.

# ACCESSORIES

Accessories > Pressure Gauge Accessories

NACE compliance, MR0175 latest edition. For 316L SS wetted parts; includes "NACE SOUR GAS SERVICE" printed on dial

## Pressure Gauge Accessories

| NACE Certificate 2.2  | "ORDER CODE" | Charge per line item or per gauge | List Price |
|---|--------------|-----------------------------------|------------|
| <b>NOTE: No charge for paper certificate. However, NACE option adder must be added to instrument options page.</b>        |              |                                   |            |
| NACE Certificate: 316L SS wetted parts material content per NACE MR0175 latest edition, add NACE charge from option pages | 2.2-N3       | per Line Item                     | No Charge  |
| NACE Certificate: MONEL® wetted parts material content per NACE MR0175 latest edition, add NACE charge from option pages  | 2.2-NMO      | per Line Item                     | No Charge  |
| Inspection Certificate 3.1  | "ORDER CODE" | Charge per line item or per gauge | List Price |
| Leak Rate Test: measuring system; leak rate < 10E-3 mbar l/s  | C3           | per Gauge                         | \$92.00    |
| Leak Rate Test: measuring system; leak rate < 10E-5 mbar l/s  | C5           | per Gauge                         | \$92.00    |
| Leak Rate Test: measuring system; leak rate < 10E-7 mbar l/s  | C7           | per Gauge                         | \$104.00   |
| Leak Rate Test: measuring system; leak rate < 10E-8 mbar l/s  | C8           | per Gauge                         | \$104.00   |
| Leak Rate Test: measuring system; leak rate < 10E-9 mbar l/s  | C9           | per Gauge                         | \$115.00   |
| Hydrostatic Test: 1.3 x full scale range; duration 5 minutes  | DA           | per Gauge                         | \$45.00    |
| Hydrostatic Test: max. static (working) pressure; duration 15 min   | DB           | per Gauge                         | \$104.00   |
| Pressurized Welding Seams carried out by a Certified Welder   | S1           | per Gauge                         | \$88.00    |
| Zone 0 Flame Proof Throttle According to Atex   | S2           | per Gauge                         | \$76.00    |
| Material Certificate 3.1: wetted parts material (metal contents) including chemical analysis                              | A3           | per Gauge                         | \$27.00    |
| Positive Material Identification  | "ORDER CODE" | Charge per line item or per gauge | List Price |
| PMI Test Report   | PMI          | per Gauge                         | \$505.00   |
| N.I.S.T. Certificates of Calibration (traceable to National Institutes of Standards and Technologies)                     | "ORDER CODE" | Charge per line item or per gauge | List Price |
| For gauges with ±3/2/3% to 0.5% of span accuracy  | CC           | per Gauge                         | \$155.00   |
| For gauges with ±0.25% of span accuracy (3XX.XX test gauges)  | CC           | per Gauge                         | \$186.00   |
| For gauges with ±0.10% of span accuracy (342.XX test gauges)  | CC           | per Gauge                         | \$248.00   |



# ACCESSORIES

Accessories > Pressure Gauge Accessories

## Pressure Gauge Accessories

| Drawings & Datasheets  | Charge per Line Item or per Instrument | List price      |
|--|--|-----------------|
| Certified Drawings<br>( <i>without</i> customer specific information)                          | per line item                          | <b>\$36.00</b>  |
| Certified Drawings<br>( <i>with</i> customer specific information)                             | per instrument                         | <b>\$108.00</b> |
| Revisions to drawings  | per drawing                            | <b>\$54.00</b>  |
| Product datasheets   | per line item                          | <b>N/C</b>      |
| Instrument tagging   | Charge per line item or per instrument | List price      |
| SS Tag with up to 4 lines, 20 character per line, attached to instrument with SS wire          | per Instrument                         | <b>\$10.00</b>  |
| Paper tag with up to 4 lines, 20 character per line, attached to instrument with cotton string | per Instrument                         | <b>\$4.00</b>   |

| Special artwork charges for pressure gauges<br>(one time charges per model and range) <sup>1</sup> | NET price             |
|--|-----------------------|
| <b>Custom Logos</b>  |                       |
| Logo, black and white only (applied to one part number)  | <b>\$215.00 NET</b>   |
| Logo, up to 3 colors (applied to one part number)  | <b>\$256.00 NET</b>   |
| Logo, up to 6 colors (applied to one part number)  | <b>\$358.00 NET</b>   |
| Charge to add existing logo to another part number   | <b>\$46.00 NET</b>    |
| <b>Special pressure scales</b> (applies to non-standard ranges & scales) *                         |                       |
| Single pressure scale<br>(eg PSI, BAR, KPA, Kg/cm <sup>2</sup> )                                   | <b>\$154.00 NET *</b> |
| Dual pressure scales<br>(eg PSI/BAR, PSI/KPA, BAR/Kg/cm <sup>2</sup> )                             | <b>\$205.00 NET *</b> |
| Calculated pressure scales<br>(eg Tons on Ram, Refrigerant scales, flow, etc.)                     | <b>\$256.00 NET</b>   |
| <b>Line imprints</b>   |                       |
| Single line imprint (30 characters max)  | <b>\$67.00 NET</b>    |
| Two line imprint (30 character max per line)   | <b>\$123.00 NET</b>   |
| <b>Color bands (no change when combined with custom logo orders)</b>                               |                       |
| Color bands, up to 3 colors (applied to one part number)   | <b>\$256.00 NET</b>   |
| Color bands, up to 6 colors (applied to one part number)   | <b>\$358.00 NET</b>   |

\* See page 264 for standard pressure ranges and scales

<sup>1</sup> Custom artwork maintained by WIKA for a maximum of 2 years from date of last shipment. New charges are required to recreate discarded artwork.

For datasheets and additional information, please visit [www.wika.com](http://www.wika.com) or call 1-888-945-2872.

# ACCESSORIES

Accessories > Pressure Gauge Accessories

## Fill liquids - sold separately

| Fill liquid  | Size (Volume)         | Part number | List price             |
|--------------|-----------------------|-------------|------------------------|
| Glycerine    | Gallon (128 oz.)      | 251         | <b>\$56.70</b>         |
|              | Squirt bottle (8 oz.) | 204         | <b>\$9.80</b>          |
| Silicone oil | Gallon (128 oz.)      | 279         | <b>\$349.20</b>        |
|              | DC 200 -1000 cst      | 207         | <b>\$35.45</b>         |
| Halocarbon®  | Squirt bottle (8 oz.) | 206         | <b>Consult factory</b> |
| Fluorolube®  | Squirt bottle (8 oz.) | 277         | <b>Consult factory</b> |

## Pressure gauge tools

| Description   | Part number | List price      |
|---|-------------|-----------------|
| Cover ring remover for Type 213.40 - 2½"                                    | 1456784     | <b>\$52.00</b>  |
| Pointer puller tool   | 9091823     | <b>\$130.65</b> |
| Spare tip for pointer puller tool   | 1400401     | <b>\$35.75</b>  |
| Threaded ring tool (for Type 2XX.34- 4½")                                   | 1031589     | <b>\$15.85</b>  |
| Pointer puller adaptor for "Long-Hub"<br>Pointers (use with #9091823 above) | 2246954     | <b>\$15.00</b>  |

# REFERENCES

References > Available Dial Artwork

## Available Dial Artwork

| Standard pressure ranges for all sizes<br>(All ranges not stocked) |           |               |                               |            |               |
|--|-----------|---------------|-------------------------------|------------|---------------|
| Single scale ranges  |           |               | Dual scale ranges (psi / ...) |            |               |
| psi  | bar       | kPa           | /kg-cm <sup>2</sup>           | /bar       | /kPa          |
| 30" Hg/0 (VAC)   | -1        | -100          | -1                            | -1         | -100          |
| 30" Hg/0/15 psi  | -1 / +1   | -100 / +100   | -1 / +1                       | -1 / +1    | -100 / +102   |
| 30" Hg/0/30 psi  | -1 / +2.5 | -100 / +250   | -1 / +2.1                     | -1 / +2    | -100 / +205   |
| 30" Hg/0/60 psi  | -1 / +4   | -100 / +400   | -1 / +4.2                     | -1 / +4    | -100 / +410   |
| 30" Hg/0/100 psi   | -1 / +6   | -100 / +600   | -1 / +7                       | -1 / +6.8  | -100 / +680   |
| 30" Hg/0/160 psi   | -1 / +10  | -100 / +1,000 | -1 / +11                      | -1 / +11   | -100 / +1,100 |
| 30" Hg/0/200 psi   | -1 / +16  | -100 / +1,600 | -1 / +14                      | -1 / +13.5 | -100 / +1,380 |
| 0/10   | 0/0.6     | 0/60          | --                            | --         | 0/69          |
| 0/15   | 0/1       | 0/100         | 0/1.04                        | 0/1.02     | 0/100         |
| 0/30   | 0/2.5     | 0/250         | 0/2.1                         | 0/2.05     | 0/200         |
| 0/60   | 0/4       | 0/400         | 0/4.2                         | 0/4.1      | 0/410         |
| 0/100  | 0/6       | 0/600         | 0/7                           | 0/6.8      | 0/690         |
| 0/160  | 0/10      | 0/1,000       | 0/11.2                        | 0/11       | 0/1,100       |
| 0/200  | 0/16      | 0/1,600       | 0/14                          | 0/13.5     | 0/1,350       |
| 0/300  | --        | --            | 0/21                          | 0/20.5     | 0/2,050       |
| 0/400  | 0/25      | 0/2,500       | 0/28                          | 0/27       | 0/2,700       |
| 0/600  | 0/40      | 0/4,000       | 0/43                          | 0/41       | 0/4,100       |
| 0/800  | --        | --            | 0/56                          | 0/55       | 0/5,400       |
| 0/1,000  | 0/60      | 0/6,000       | 0/70                          | 0/68       | 0/6,800       |
| 0/1,500  | 0/100     | 0/10,000      | 0/104                         | 0/102      | 0/10,200      |
| 0/2,000  | 0/160     | 0/16,000      | 0/140                         | 0/135      | 0/13,500      |
| 0/3,000  | 0/250     | 0/25,000      | 0/210                         | 0/205      | 0/20,500      |
| 0/5,000  | --        | --            | 0/350                         | 0/340      | 0/34,000      |
| 0/6,000  | 0/400     | 0/40,000      | 0/420                         | 0/410      | 0/41,000      |
| 0/7,500  |           |               | 0/530                         | 0/517      | 0/50,000      |
| 0/10,000   | 0/600     | 0/60,000      | 0/700                         | 0/690      | 0/68,000      |
| 0/15,000   | 0/1,000   | 0/100,000     | 0/1,050                       | 0/1,030    | 0/102,000     |
| 0/20,000   | 0/1,600   | 0/160,000     | 0/1,400                       | 0/1,380    | 0/137,000     |

| PSI / Ft. H <sub>2</sub> O dual scales<br>For type 2XX.34 - 4 1/2" |                      |
|--|----------------------|
| PSI  | Ft. H <sub>2</sub> O |
| 30/0/15  | -34/0/34             |
| 30/0/30  | -34/0/70             |
| 15   | 34                   |
| 30   | 70                   |
| 60   | 140                  |
| 100  | 230                  |
| 160  | 370                  |
| 200  | 460                  |

To order type 2XX.34 gauges with dual scale psi / ft. H<sub>2</sub>O dials, specify gauge part number + the following numbers:

XXX = psi range desired

Ex: 232.34 4 1/2" XXX psi / ft. H<sub>2</sub>O 1/2" L

There is no additional charge or minimum quantity for this option in the ranges listed above.

**NOTE:**

WIKA is capable of producing almost any type of custom artwork, including special scales, fonts and logo's. Please contact your WIKA distributor or the factory for availability and lead times.

ACCESSORIES

# REFERENCES

References > Standard Dial Layouts

## Standard Dial Layouts

**Accuracy (+/-) 3/2/3%, 2.5%, 1.5% (+/-) 2/1/2 & 1.0% F.S.**

Types 1XX.XX and 2XX.XX

(not including type 2XX.34 process gauges)

| Pressure ranges           |                    |              |                   |              |
|---------------------------|--------------------|--------------|-------------------|--------------|
|                           | Size 1½", 2" & 2½" |              | Size 3½", 4" & 6" |              |
| Range                     | Fig. inter.        | Grad. inter. | Fig. inter.       | Grad. inter. |
| PSI                       | PSI                | PSI          | PSI               | PSI          |
| 10                        | 2                  | 0.2          | --                | --           |
| 15                        | 3                  | 0.2          | 3                 | 0.2          |
| 30                        | 5                  | 0.5          | 5                 | 0.5          |
| 60                        | 10                 | 1            | 10                | 1            |
| 100                       | 20                 | 2            | 10                | 1            |
| 160                       | 20                 | 2            | 20                | 2            |
| 200                       | 50                 | 5            | 20                | 2            |
| 300                       | 50                 | 5            | 50                | 5            |
| 400                       | 100                | 10           | 50                | 5            |
| 600                       | 100                | 10           | 100               | 10           |
| 800                       | 200                | 20           | 100               | 10           |
| 1,000                     | 200                | 20           | 100               | 10           |
| 1,500                     | 300                | 20           | 300               | 20           |
| 2,000                     | 500                | 50           | 200               | 20           |
| 3,000                     | 500                | 50           | 500               | 50           |
| 5,000                     | 1,000              | 100          | 500               | 50           |
| 7,500                     | 1,000              | 100          | --                | --           |
| 10,000                    | 2,000              | 200          | 1,000             | 100          |
| 15,000                    | 3,000              | 200          | 3,000             | 200          |
| 20,000                    | ---                | ---          | 2,000             | 200          |
| Vacuum range <sup>1</sup> |                    |              |                   |              |
| Range                     | Fig. inter.        | Grad. inter. | Fig. inter.       | Grad. inter. |
| 30-0 "Hg                  | 5 "Hg              | 0.5 "Hg      | 5 "Hg             | 0.5 "Hg      |
| Compound ranges           |                    |              |                   |              |
| Range                     | Fig. inter.        | Grad. inter. | Fig. inter.       | Grad. inter. |
| "Hg PSI                   | "Hg PSI            | "Hg PSI      | "Hg PSI           | "Hg PSI      |
| 30-0- 15                  | 10 5               | 1 0.5        | 5 3               | 1 0.5        |
| 30-0- 30                  | 10 10              | 2 1          | 10 5              | 1 0.5        |
| 30-0- 60                  | 30 20              | 2 2          | 10 10             | 2 2          |
| 30-0- 100                 | 30 20              | 5 2          | 30 10             | 5 2          |
| 30-0- 160                 | 30 20              | 10 5         | 30 20             | 5 5          |
| 30-0- 200                 | 30 20              | 10 5         | 30 20             | 5 5          |

<sup>1</sup> Pointer travel in vacuum range gauges is counter-clockwise

### ABBREVIATIONS

**Fig. inter.** - spacing between numbers (figures) printed on dial.

**Grad. inter.** - spacing between tick marks (graduations) printed on dial.

**F.S.** - full scale. All accuracies are percentages of the full scale range of the gauge.

**Accuracy (+/-) 0.5% of span**

Type 2XX.34 process gauges

| Pressure ranges           |             |              |
|---------------------------|-------------|--------------|
| Size 4½", 6"              |             |              |
| Range                     | Fig. inter. | Grad. inter. |
| PSI                       | PSI         | PSI          |
| 15                        | 1           | 0.1          |
| 30                        | 5           | 0.2          |
| 60                        | 5           | 0.5          |
| 100                       | 10          | 1            |
| 160                       | 20          | 1            |
| 200                       | 20          | 2            |
| 300                       | 50          | 2            |
| 400                       | 50          | 5            |
| 600                       | 50          | 5            |
| 800                       | 100         | 10           |
| 1,000                     | 100         | 10           |
| 1,500                     | 200         | 10           |
| 2,000                     | 200         | 20           |
| 3,000                     | 500         | 20           |
| 5,000                     | 500         | 50           |
| 10,000                    | 1,000       | 100          |
| 15,000                    | 2,000       | 100          |
| 20,000                    | 2,000       | 200          |
| Vacuum range <sup>1</sup> |             |              |
| Range                     | Fig. inter. | Grad. inter. |
| 30 - 0 "Hg                | 5 "Hg       | 0.2 "Hg      |
| Compound ranges           |             |              |
| Range                     | Fig. inter. | Grad. inter. |
| "Hg PSI                   | "Hg PSI     | "Hg PSI      |
| 30-0-15                   | 5 3         | 0.5 0.2      |
| 30-0-30                   | 10 5        | 1 0.5        |
| 30-0-60                   | 10 10       | 1 1          |
| 30-0-100                  | 30 10       | 2 1          |
| 30-0-160                  | 30 20       | 5 2          |
| 30-0-200                  | 30 20       | 5 2          |

# REFERENCES

References > Standard Dial Layouts

## Standard Dial Layouts

### Accuracy (+/-) 0.25% of span

Type 3XX.XX test gauges

| Pressure ranges           |             |             |
|---------------------------|-------------|-------------|
| Size 4" & 6"              |             |             |
| Range                     | Fig. inter. | Grad inter. |
| PSI                       | PSI         | PSI         |
| 15                        | 1           | 0.05        |
| 60                        | 5           | 0.2         |
| 100                       | 10          | 0.5         |
| 160                       | 10          | 1           |
| 200                       | 20          | 1           |
| 400                       | 50          | 2           |
| 600                       | 50          | 2           |
| 800                       | 100         | 5           |
| 3000                      | 200         | 10          |
| 5000                      | 500         | 20          |
| 10000                     | 1000        | 50          |
| 15000                     | 1000        | 50          |
| 20000                     | 2000        | 100         |
| Vacuum range <sup>1</sup> |             |             |
| Range                     | Fig. inter. | Grad inter. |
| 30-0 "Hg                  | 2 " Hg      | 0.1 " Hg    |
| Compound ranges           |             |             |
| Range                     | Fig. inter. | Grad inter. |
| " Hg    PSI               | " Hg    PSI | " Hg    PSI |
| 30 -0- 15                 | 5    5      | 0.2    0.1  |
| 30 -0- 30                 | 5    5      | 0.5    0.2  |
| 30 -0- 60                 | 5    5      | 1    0.5    |
| 30 -0- 100                | 10    10    | 1    0.5    |
| 30 -0- 160                | 10    10    | 2    1      |
| 30 -0- 2000               | 20    20    | 2    1      |

<sup>1</sup> Pointer travel in vacuum range gauges is counter-clockwise

### ABBREVIATIONS

**Fig. inter.** - spacing between numbers (figures) printed on dial.

**Grad. inter.** - spacing between tick marks (graduations) printed on dial.

**F.S.** - full scale. All accuracies are percentages of the full scale range of the gauge.

### Accuracy (+/-) 0.1% of span

Type 342.11 precision test gauges

| Pressure ranges           |             |             |
|---------------------------|-------------|-------------|
| Size 10"                  |             |             |
| Range                     | Fig. inter. | Grad inter. |
| PSI                       | PSI         | PSI         |
| 10                        | 0.5         | 0.02        |
| 15                        | 0.5         | 0.02        |
| 20                        | 1           | 0.05        |
| 30                        | 1           | 0.05        |
| 60                        | 2           | 0.1         |
| 100                       | 5           | 0.2         |
| 150                       | 5           | 0.2         |
| 200                       | 10          | 0.5         |
| 300                       | 10          | 0.5         |
| 400                       | 20          | 1           |
| 600                       | 20          | 1           |
| 800                       | 20          | 1           |
| 1,000                     | 50          | 2           |
| 1,500                     | 50          | 2           |
| 2,000                     | 100         | 5           |
| 3,000                     | 100         | 5           |
| 4,000                     | 200         | 10          |
| 5,000                     | 500         | 10          |
| 6,000                     | 200         | 10          |
| 7,500                     | 500         | 20          |
| 10,000                    | 500         | 20          |
| 15,000                    | 500         | 20          |
| 20,000                    | 1,000       | 50          |
| Range                     | Fig. inter. | Grad inter. |
| in. water                 | in. water   | in. water   |
| 300                       | 15          | 0.5         |
| 400, 500, 600, 800        | 20          | 1           |
| 1,000                     | 50          | 2           |
| Vacuum range <sup>1</sup> |             |             |
| Range                     | Fig. inter. | Grad inter. |
| 30-0 "Hg                  | 2 "Hg       | 0.1 "Hg     |
| Compound ranges           |             |             |
| Range                     | Fig. inter. | Grad inter. |
| " Hg    PSI               | "Hg    PSI  | "Hg    PSI  |
| 30 -0- 15                 | 5    2      | 0.1    0.1  |
| 30 -0- 30                 | 5    2      | 0.1    0.1  |
| 30 -0- 60                 | 5    5      | 0.2    0.5  |
| 30 -0- 100                | 10    5     | 0.5    0.5  |
| 30 -0- 150                | 10    10    | 1    0.5    |
| 30 -0- 300                | 10    10    | 1    0.5    |

ACCESSORIES

# REFERENCES

References > Standard Dial Layouts

## Standard Dial Layouts

Accuracy (+/-) 1.5% & 2.5% of span

Type 4XX.XX Sealgauges

| Pressure ranges           |     |             |     |              |     |
|---------------------------|-----|-------------|-----|--------------|-----|
| Sealgauge sizes 4" & 6"   |     |             |     |              |     |
| Range                     |     | Fig. inter. |     | Grad. inter. |     |
| in. water                 |     | in. water   |     | in. water    |     |
| 5                         |     | 1           |     | 0.10         |     |
| 10                        |     | 1           |     | 0.10         |     |
| 15                        |     | 3           |     | 0.25         |     |
| 30                        |     | 5           |     | 0.50         |     |
| 60                        |     | 10          |     | 1            |     |
| 100                       |     | 10          |     | 1            |     |
| 200                       |     | 20          |     | 2            |     |
| Range                     |     | Fig. inter. |     | Grad. inter. |     |
| Oz./Sq. in.               |     | Oz./Sq. in. |     | Oz./Sq. in.  |     |
| 5                         |     | 1           |     | 0.10         |     |
| 10                        |     | 1           |     | 0.10         |     |
| 15                        |     | 3           |     | 0.25         |     |
| 20                        |     | 2           |     | 0.20         |     |
| 30                        |     | 5           |     | 0.50         |     |
| 35                        |     | 5           |     | 0.50         |     |
| 60                        |     | 10          |     | 1            |     |
| 100                       |     | 20          |     | 2            |     |
| 180                       |     | 50          |     | 5            |     |
| Range                     |     | Fig. inter. |     | Grad. inter. |     |
| PSI                       |     | PSI         |     | PSI          |     |
| 10                        |     | 1           |     | 0.2          |     |
| 15                        |     | 3           |     | 0.5          |     |
| 30                        |     | 5           |     | 0.5          |     |
| 60                        |     | 10          |     | 1            |     |
| 100                       |     | 10          |     | 1            |     |
| 160                       |     | 20          |     | 2            |     |
| 200                       |     | 20          |     | 2            |     |
| 300                       |     | 50          |     | 5            |     |
| 400                       |     | 50          |     | 5            |     |
| 600                       |     | 50          |     | 5            |     |
| Vacuum range <sup>1</sup> |     |             |     |              |     |
| Range                     |     | Fig. inter. |     | Grad. inter. |     |
| PSI                       |     | PSI         |     | PSI          |     |
| 30-0 "Hg                  |     | 5 "Hg       |     | 0.5 "Hg      |     |
| Compound ranges           |     |             |     |              |     |
| Range                     |     | Fig. inter. |     | Grad. inter. |     |
| "Hg                       | PSI | "Hg         | PSI | "Hg          | PSI |
| 30 - 0 - 10               |     | 5           | 2   | 0.5          | 0.2 |
| 30 - 0 - 15               |     | 5           | 3   | 1            | 0.5 |
| 30 - 0 - 30               |     | 10          | 5   | 1            | 0.5 |
| 30 - 0 - 60               |     | 10          | 10  | 2            | 2   |
| 30 - 0 - 100              |     | 10          | 10  | 5            | 2   |
| 30 - 0 - 160              |     | 30          | 20  | 5            | 2   |
| 30 - 0 - 200              |     | 30          | 20  | 5            | 2   |
| 30 - 0 - 300              |     | 30          | 50  | 5            | 2   |
| 30 - 0 - 400              |     | 30          | 50  | 10           | 5   |

<sup>1</sup> Pointer travel in vacuum range gauges is counter-clockwise

### ABBREVIATIONS

**Fig. inter.** - spacing between numbers (figures) printed on dial.

**Grad. inter.** - spacing between tick marks (graduations) printed on dial.

**F.S.** - full scale. All accuracies are percentages of the full scale range of the gauge.

# REFERENCES

References > Standard Dial Layouts

## Standard Dial Layouts

Accuracy (+/-) 1.5% F.S.

Type 6XX.XX low pressure gauges

| Pressure range            |               |                             |               |                              |               |                             |               |                              |               |
|---------------------------|---------------|-----------------------------|---------------|------------------------------|---------------|-----------------------------|---------------|------------------------------|---------------|
| Size 2½"                  |               |                             |               | Size 4"                      |               |                             |               |                              |               |
| Range<br>(dual scale)     |               | Fig. inter.<br>(dual scale) |               | Grad. inter.<br>(dual scale) |               | Fig. inter.<br>(dual scale) |               | Grad. inter.<br>(dual scale) |               |
| Inch<br>water             | (mm<br>water) | Inch<br>water               | (mm<br>water) | Inch<br>water                | (mm<br>water) | Inch<br>water               | (mm<br>water) | Inch<br>water                | (mm<br>water) |
| 15                        | (380)         | 5                           | (100)         | 0.5                          | (10)          | 3                           | (50)          | 0.2                          | (5)           |
| 30                        | (760)         | 5                           | (200)         | 0.5                          | (10)          | 5                           | (100)         | 0.5                          | (10)          |
| 60                        | (1,500)       | 10                          | (500)         | 1                            | (50)          | 10                          | (300)         | 1                            | (20)          |
| 100                       | (2,500)       | 20                          | (500)         | 2                            | (50)          | 10                          | (500)         | 1                            | (50)          |
| 200                       | (5,000)       | 50                          | (1,000)       | 5                            | (100)         | 20                          | (1,000)       | 2                            | (100)         |
| Range<br>(dual scale)     |               | Fig. inter.<br>(dual scale) |               | Grad. inter.<br>(dual scale) |               | Fig. inter.<br>(dual scale) |               | Grad. inter.<br>(dual scale) |               |
| Oz./<br>Sq. in.           | (mm<br>water) | Oz./<br>Sq. in.             | (mm<br>water) | Oz./<br>Sq. in.              | (mm<br>water) | Oz./<br>Sq. in.             | (mm<br>water) | Oz./<br>Sq. in.              | (mm<br>water) |
| 10                        | (400)         | 2                           | (100)         | 0.2                          | (10)          | 1                           | (100)         | 0.1                          | (10)          |
| 15                        | (660)         | 5                           | (100)         | 0.5                          | (10)          | 3                           | (100)         | 0.2                          | (10)          |
| 20                        | (880)         | 5                           | (200)         | 0.5                          | (20)          | 2                           | (200)         | 0.2                          | (20)          |
| 30                        | (1,320)       | 5                           | (200)         | 0.5                          | (50)          | 5                           | (200)         | 0.5                          | (20)          |
| 35                        | (1,540)       | 5                           | (500)         | 0.5                          | (50)          | 5                           | (300)         | 0.5                          | (20)          |
| 60                        | (2,640)       | 10                          | (500)         | 1                            | (50)          | 10                          | (500)         | 1                            | (50)          |
| Range<br>(dual scale)     |               | Fig. inter.<br>(dual scale) |               | Grad. inter.<br>(dual scale) |               | Fig. inter.<br>(dual scale) |               | Grad. inter.<br>(dual scale) |               |
| Oz./<br>Sq. in.           | (mm<br>water) | Oz./<br>Sq. in.             | (mm<br>water) | Oz./<br>Sq. in.              | (mm<br>water) | Oz./<br>Sq. in.             | (mm<br>water) | Oz./<br>Sq. in.              | (mm<br>water) |
| 20                        | (34)          | 20                          | (34)          | 20                           | (34)          | 20                          | (34)          | 20                           | (34)          |
| 20                        | (34)          | 20                          | (34)          | 20                           | (34)          | 20                          | (34)          | 20                           | (34)          |
| Range                     |               | Fig. inter.                 |               | Grad. inter.                 |               | Fig. inter.                 |               | Grad. inter.                 |               |
| PSI                       |               | PSI                         |               | PSI                          |               | PSI                         |               | PSI                          |               |
| 3                         |               | 0.5                         |               | 0.05                         |               | 0.5                         |               | 0.05                         |               |
| 5                         |               | 1                           |               | 0.1                          |               | 0.5                         |               | 0.5                          |               |
| 10                        |               | 2                           |               | 0.2                          |               | 1                           |               | 0.1                          |               |
| Vacuum range <sup>1</sup> |               |                             |               |                              |               |                             |               |                              |               |
| Range<br>(dual scale)     |               | Fig. inter.<br>(dual scale) |               | Grad. inter.<br>(dual scale) |               | Fig. inter.<br>(dual scale) |               | Grad. inter.<br>(dual scale) |               |
| Inch<br>water             | (mm<br>water) | Inch<br>water               | (mm<br>water) | Inch<br>water                | (mm<br>water) | Inch<br>water               | (mm<br>water) | Inch<br>water                | (mm<br>water) |
| 30-0                      | (760)         | 5                           | (200)         | 0.5                          | (20)          | 5                           | (7100)        | 0.5                          | (10)          |

<sup>1</sup> Pointer travel in vacuum range gauges is counter-clockwise

### ABBREVIATIONS

**Fig. inter.** - spacing between numbers (figures) printed on dial.

**Grad. inter.** - spacing between tick marks (graduations) printed on dial.

**F.S.** - full scale. All accuracies are percentages of the full scale range of the gauge.

# REFERENCES

References > Conversion Chart

## How to convert from °Celsius to °Fahrenheit, or °Fahrenheit to °Celsius

Locate the known temperature (either Fahrenheit or Celsius) in the center shaded column.

Read left to convert from Celsius to Fahrenheit,  
or right to convert from Fahrenheit to Celsius.

| To °F  | From | To °C  | To °F | From | To °C | To °F | From | To °C  | To °F | From | To °C  | To °F | From | To °C  | To °F  | From | To °C  |
|--------|------|--------|-------|------|-------|-------|------|--------|-------|------|--------|-------|------|--------|--------|------|--------|
| -148   | -100 | -73.33 | 75.2  | 24   | -4.51 | 298.4 | 148  | 64.31  | 521.6 | 272  | 133.13 | 744.8 | 396  | 201.95 | 968    | 520  | 271.11 |
| -144.4 | -98  | -72.22 | 78.8  | 26   | -3.4  | 302   | 150  | 65.42  | 525.2 | 274  | 134.24 | 748.4 | 398  | 203.06 | 971.6  | 522  | 272.22 |
| -140.8 | -96  | -71.11 | 82.4  | 28   | -2.29 | 305.6 | 152  | 66.53  | 528.8 | 276  | 135.35 | 752   | 400  | 204.17 | 975.2  | 524  | 273.33 |
| -137.2 | -94  | -70    | 86    | 30   | -1.18 | 309.2 | 154  | 67.64  | 532.4 | 278  | 136.46 | 755.6 | 402  | 205.28 | 978.8  | 526  | 274.44 |
| -133.6 | -92  | -68.89 | 89.6  | 32   | -0.07 | 312.8 | 156  | 68.75  | 536   | 280  | 137.57 | 759.2 | 404  | 206.39 | 982.4  | 528  | 275.56 |
| -130   | -90  | -67.78 | 93.2  | 34   | 1.04  | 316.4 | 158  | 69.86  | 539.6 | 282  | 138.68 | 762.8 | 406  | 207.5  | 986    | 530  | 276.67 |
| -126.4 | -88  | -66.67 | 96.8  | 36   | 2.15  | 320   | 160  | 70.97  | 543.2 | 284  | 139.79 | 766.4 | 408  | 208.61 | 989.6  | 532  | 277.78 |
| -122.8 | -86  | -65.56 | 100.4 | 38   | 3.26  | 323.6 | 162  | 72.08  | 546.8 | 286  | 140.9  | 770   | 410  | 209.72 | 993.2  | 534  | 278.89 |
| -119.2 | -84  | -64.45 | 104   | 40   | 4.37  | 327.2 | 164  | 73.19  | 550.4 | 288  | 142.01 | 773.6 | 412  | 210.83 | 996.8  | 536  | 280    |
| -115.6 | -82  | -63.34 | 107.6 | 42   | 5.48  | 330.8 | 166  | 74.3   | 554   | 290  | 143.12 | 777.2 | 414  | 211.94 | 1000.4 | 538  | 281.11 |
| -112   | -80  | -62.23 | 111.2 | 44   | 6.59  | 334.4 | 168  | 75.41  | 557.6 | 292  | 144.23 | 780.8 | 416  | 213.05 | 1004   | 540  | 282.22 |
| -108.4 | -78  | -61.12 | 114.8 | 46   | 7.7   | 338   | 170  | 76.52  | 561.2 | 294  | 145.34 | 784.4 | 418  | 214.16 | 1007.6 | 542  | 283.33 |
| -104.8 | -76  | -60.01 | 118.4 | 48   | 8.81  | 341.6 | 172  | 77.63  | 564.8 | 296  | 146.45 | 788   | 420  | 215.27 | 1011.2 | 544  | 284.44 |
| -101.2 | -74  | -58.9  | 122   | 50   | 9.92  | 345.2 | 174  | 78.74  | 568.4 | 298  | 147.56 | 791.6 | 422  | 216.38 | 1014.8 | 546  | 285.56 |
| -97.6  | -72  | -57.79 | 125.6 | 52   | 11.03 | 348.8 | 176  | 79.85  | 572   | 300  | 148.67 | 795.2 | 424  | 217.49 | 1018.4 | 548  | 286.67 |
| -94    | -70  | -56.68 | 129.2 | 54   | 12.14 | 352.4 | 178  | 80.96  | 575.6 | 302  | 149.78 | 798.8 | 426  | 218.6  | 1022   | 550  | 287.78 |
| -90.4  | -68  | -55.57 | 132.8 | 56   | 13.25 | 356   | 180  | 82.07  | 579.2 | 304  | 150.89 | 802.4 | 428  | 219.71 | 1040   | 560  | 293.33 |
| -86.8  | -66  | -54.46 | 136.4 | 58   | 14.36 | 359.6 | 182  | 83.18  | 585.8 | 306  | 152    | 806   | 430  | 220.82 | 1058   | 570  | 298.89 |
| -83.2  | -64  | -53.35 | 140   | 60   | 15.47 | 363.2 | 184  | 84.29  | 586.4 | 308  | 153.11 | 809.6 | 432  | 221.93 | 1076   | 580  | 304.44 |
| -79.6  | -62  | -52.24 | 143.6 | 62   | 16.58 | 366.8 | 186  | 85.4   | 590   | 310  | 154.22 | 813.2 | 434  | 223.04 | 1094   | 590  | 310    |
| -76    | -60  | -51.13 | 147.2 | 64   | 17.69 | 370.4 | 188  | 86.51  | 593.6 | 312  | 155.33 | 816.8 | 436  | 224.15 | 1112   | 600  | 315.66 |
| -72.4  | -58  | -50.02 | 150.8 | 66   | 18.8  | 374   | 190  | 87.62  | 597.2 | 314  | 156.44 | 820.4 | 438  | 225.26 | 1130   | 610  | 321.11 |
| -68.8  | -56  | -48.91 | 154.4 | 68   | 19.91 | 377.6 | 192  | 88.73  | 600.8 | 316  | 157.55 | 824   | 440  | 226.37 | 1148   | 620  | 326.22 |
| -65.2  | -54  | -47.8  | 158   | 70   | 21.02 | 381.2 | 194  | 89.84  | 604.4 | 318  | 158.66 | 827.6 | 442  | 227.48 | 1166   | 630  | 332.22 |
| -61.6  | -52  | -46.69 | 161.6 | 72   | 22.13 | 384.8 | 196  | 90.95  | 608   | 320  | 159.77 | 831.2 | 444  | 228.59 | 1184   | 640  | 337.78 |
| -58    | -50  | -45.58 | 165.2 | 74   | 23.24 | 388.4 | 198  | 92.06  | 611.6 | 322  | 160.88 | 834.8 | 446  | 229.7  | 1202   | 650  | 343.33 |
| -54.4  | -48  | -44.47 | 168.8 | 76   | 24.35 | 392   | 200  | 93.17  | 615.2 | 324  | 161.99 | 838.4 | 448  | 230.81 | 1220   | 660  | 348.89 |
| -50.8  | -46  | -43.36 | 172.4 | 78   | 25.46 | 395.6 | 202  | 94.28  | 618.8 | 326  | 163.1  | 842   | 450  | 231.92 | 1238   | 670  | 354.44 |
| -47.2  | -44  | -42.25 | 176   | 80   | 26.57 | 399.2 | 204  | 95.39  | 622.4 | 328  | 164.21 | 845.6 | 452  | 233.03 | 1256   | 680  | 360    |
| -43.6  | -42  | -41.14 | 179.6 | 82   | 27.68 | 402.8 | 206  | 96.5   | 626   | 330  | 165.32 | 849.2 | 454  | 234.14 | 1274   | 690  | 365.56 |
| -40    | -40  | -40.03 | 183.2 | 84   | 28.79 | 406.4 | 208  | 97.61  | 629.6 | 332  | 166.43 | 852.8 | 456  | 235.25 | 1292   | 700  | 371.11 |
| -36.4  | -38  | -38.92 | 186.8 | 86   | 29.9  | 410   | 210  | 98.72  | 633.2 | 334  | 167.54 | 856.4 | 458  | 236.36 | 1310   | 710  | 376.67 |
| -32.8  | -36  | -37.81 | 190.4 | 88   | 31.01 | 413.6 | 212  | 99.83  | 636.8 | 336  | 168.65 | 860   | 460  | 237.47 | 1328   | 720  | 382.22 |
| -29.2  | -34  | -36.7  | 194   | 90   | 32.12 | 417.2 | 214  | 100.94 | 640.4 | 338  | 169.76 | 863.6 | 462  | 238.58 | 1346   | 730  | 387.78 |
| -25.6  | -32  | -35.59 | 197.6 | 92   | 33.23 | 420.8 | 216  | 102.05 | 644   | 340  | 170.87 | 867.2 | 464  | 239.69 | 1364   | 740  | 393.33 |
| -22    | -30  | -34.48 | 201.2 | 94   | 34.34 | 424.4 | 218  | 103.16 | 647.6 | 342  | 171.98 | 870.8 | 466  | 240.8  | 1382   | 750  | 398.89 |
| -18.4  | -28  | -33.37 | 204.8 | 96   | 35.45 | 428   | 220  | 104.27 | 651.2 | 344  | 173.09 | 874.4 | 468  | 241.91 | 1400   | 760  | 404.44 |
| -14.8  | -26  | -32.26 | 208.4 | 98   | 36.56 | 431.6 | 222  | 105.38 | 654.8 | 346  | 174.2  | 878   | 470  | 243.02 | 1418   | 770  | 410    |
| -11.2  | -24  | -31.15 | 212   | 100  | 37.67 | 435.2 | 224  | 106.49 | 658.4 | 348  | 175.31 | 881.6 | 472  | 244.13 | 1436   | 780  | 415.56 |
| -7.6   | -22  | -30.04 | 215.6 | 102  | 38.78 | 438.8 | 226  | 107.6  | 662   | 350  | 176.42 | 885.2 | 474  | 245.24 | 1454   | 790  | 421.11 |
| -4     | -20  | -28.93 | 219.2 | 104  | 39.89 | 442.4 | 228  | 108.71 | 665.6 | 352  | 177.53 | 888.8 | 476  | 246.35 | 1472   | 800  | 426.67 |
| -0.4   | -18  | -27.82 | 222.8 | 106  | 41    | 446   | 230  | 109.82 | 669.2 | 354  | 178.64 | 892.4 | 478  | 247.46 | 1490   | 810  | 432.22 |
| 3.2    | -16  | -26.71 | 226.4 | 108  | 42.11 | 449.6 | 232  | 110.93 | 672.8 | 356  | 179.75 | 896   | 480  | 248.57 | 1508   | 820  | 437.78 |
| 6.8    | -14  | -25.6  | 230   | 110  | 43.22 | 453.2 | 234  | 112.04 | 676.4 | 358  | 180.86 | 899.6 | 482  | 249.68 | 1526   | 830  | 443.33 |
| 10.4   | -12  | -24.49 | 233.6 | 112  | 44.33 | 456.8 | 236  | 113.15 | 680   | 360  | 181.97 | 903.2 | 484  | 250.79 | 1544   | 840  | 448.89 |
| 14     | -10  | -23.38 | 237.2 | 114  | 45.44 | 460.4 | 238  | 114.26 | 683.6 | 362  | 183.08 | 906.8 | 486  | 251.9  | 1562   | 850  | 454.44 |
| 17.6   | -8   | -22.27 | 240.8 | 116  | 46.55 | 464   | 240  | 115.37 | 687.2 | 364  | 184.19 | 910.4 | 488  | 253.01 | 1580   | 860  | 460    |
| 21.2   | -6   | -21.16 | 244.4 | 118  | 47.66 | 467.6 | 242  | 116.48 | 690.8 | 366  | 185.3  | 914   | 490  | 254.12 | 1598   | 870  | 465.56 |
| 24.8   | -4   | -20.05 | 248   | 120  | 48.77 | 471.2 | 244  | 117.59 | 694.4 | 368  | 186.41 | 917.6 | 492  | 255.23 | 1616   | 880  | 471.11 |
| 28.4   | -2   | -18.94 | 251.6 | 122  | 49.88 | 474.8 | 246  | 118.7  | 698   | 370  | 187.52 | 921.2 | 494  | 256.34 | 1634   | 890  | 476.67 |
| 32     | 0    | -17.83 | 255.2 | 124  | 50.99 | 478.4 | 248  | 119.81 | 701.6 | 372  | 188.63 | 924.8 | 496  | 257.45 | 1652   | 900  | 482.22 |
| 35.6   | 2    | -16.72 | 258.8 | 126  | 52.1  | 482   | 250  | 120.92 | 705.2 | 374  | 189.74 | 928.4 | 498  | 258.56 | 1670   | 910  | 487.78 |
| 39.2   | 4    | -15.61 | 262.4 | 128  | 53.21 | 485.6 | 252  | 122.03 | 708.8 | 376  | 190.85 | 932   | 500  | 259.67 | 1688   | 920  | 493.33 |
| 42.8   | 6    | -14.5  | 266   | 130  | 54.32 | 489.2 | 254  | 123.14 | 712.4 | 378  | 191.96 | 935.6 | 502  | 260.78 | 1706   | 930  | 498.89 |
| 46.4   | 8    | -13.39 | 269.6 | 132  | 55.43 | 492.8 | 256  | 124.25 | 716   | 380  | 193.07 | 939.2 | 504  | 261.89 | 1724   | 940  | 504.44 |
| 50     | 10   | -12.28 | 273.2 | 134  | 56.54 | 496.4 | 258  | 125.36 | 719.6 | 382  | 194.18 | 942.8 | 506  | 263.0  | 1742   | 950  | 510    |
| 53.6   | 12   | -11.17 | 276.8 | 136  | 57.65 | 500   | 260  | 126.47 | 723.2 | 384  | 195.29 | 946.4 | 508  | 264.11 | 1760   | 960  | 515.56 |
| 57.2   | 14   | -10.06 | 280.4 | 138  | 58.76 | 503.6 | 262  | 127.58 | 726.8 | 386  | 196.4  | 950   | 510  | 265.22 | 1778   | 970  | 521.11 |
| 60.8   | 16   | -8.95  | 284   | 140  | 59.87 | 507.2 | 264  | 128.69 | 730.4 | 388  | 197.51 | 953.6 | 512  | 266.33 | 1796   | 980  | 526.67 |
| 64.4   | 18   | -7.84  | 287.6 | 142  | 60.98 | 510.8 | 266  | 129.8  | 734   | 390  | 198.62 | 957.2 | 514  | 267.44 | 1814   | 990  | 532.22 |
| 68     | 20   | -6.73  | 291.2 | 144  | 62.09 | 514.4 | 268  | 130.91 | 737.6 | 392  | 199.73 | 960.8 | 516  | 268.55 | 1832   | 1000 | 537.78 |
| 71.6   | 22   | -5.62  | 294.8 | 146  | 63.2  | 518   | 270  | 132.02 | 741.2 | 394  | 200.84 | 964.4 | 518  | 269.66 |        |      |        |

$$^{\circ}\text{F} = (9/5\ ^{\circ}\text{C}) + 32 \quad ^{\circ}\text{C} = 5/9 ( ^{\circ}\text{F} - 32 )$$



# REFERENCES

References > Pressure Units Cross Reference Chart

## Pressure Units Cross Reference Chart

| PSI      | atms.    | H <sub>2</sub> O | mm H <sub>2</sub> O | cm H <sub>2</sub> O | oz/in <sup>2</sup> | Kg/cm <sup>2</sup> | "Hg      | mm Hg (Torr) | cm Hg   | mbar   | bar      | Pa (Nm <sup>2</sup> ) | kPa    | MPa      |
|----------|----------|------------------|---------------------|---------------------|--------------------|--------------------|----------|--------------|---------|--------|----------|-----------------------|--------|----------|
| 1        | 0.0681   | 27.71            | 703.8               | 70.38               | 16                 | 0.0704             | 2.036    | 51.715       | 5.17    | 68.95  | 0.0689   | 6895                  | 6.895  | 0.0069   |
| 14.7     | 1        | 407.2            | 10,343              | 1,034.3             | 235.1              | 1.033              | 29.92    | 760          | 76      | 1013   | 1.013    | 101,325               | 101.3  | 0.1013   |
| 0.0361   | 0.00246  | 1                | 25.4                | 2.54                | 0.5775             | 0.00254            | 0.0735   | 1.866        | 0.187   | 2.488  | 0.00249  | 248.8                 | 0.249  | 0.00025  |
| 0.001421 | 0.000097 | 0.0394           | 1                   | 0.1                 | 0.0227             | 0.0001             | 0.00289  | 0.0735       | 0.00735 | 0.098  | 0.000098 | 9.8                   | 0.0098 | 0.00001  |
| 0.01421  | 0.000967 | 0.3937           | 10                  | 1                   | 0.227              | 0.001              | 0.0289   | 0.735        | 0.0735  | 0.98   | 0.00098  | 98                    | 0.098  | 0.0001   |
| 0.0625   | 0.00425  | 1.732            | 43,986              | 4.40                | 1                  | 0.0044             | 0.1273   | 3.232        | 0.323   | 4.31   | 0.00431  | 431                   | 0.431  | 0.00043  |
| 14.22    | 0.968    | 394.1            | 100,010             | 1,001               | 227.6              | 1                  | 28.96    | 735.6        | 73.56   | 980.7  | 0.981    | 98,067                | 98.07  | 0.0981   |
| 0.4912   | 0.03342  | 13.61            | 345.7               | 34.57               | 7.858              | 0.0345             | 1        | 25.4         | 2.54    | 33.86  | 0.0339   | 3386                  | 3.386  | 0.00339  |
| 0.01934  | 0.001316 | 0.536            | 13.61               | 1.361               | 0.310              | 0.00136            | 0.0394   | 1            | .1      | 1.333  | 0.001333 | 133.3                 | 0.1333 | 0.000133 |
| 0.1934   | 0.01316  | 5.358            | 136.1               | 13.61               | 3.10               | 0.0136             | 0.394    | 10           | 1       | 13.33  | 0.01333  | 1333                  | 1.333  | 0.00133  |
| 0.0145   | 0.000987 | 0.4012           | 10.21               | 1.021               | 0.2321             | 0.00102            | 0.0295   | 0.75         | 0.075   | 1      | 0.001    | 100                   | 0.1    | 0.0001   |
| 14.504   | 0.987    | 401.9            | 10,210              | 1021                | 232.1              | 1.02               | 29.53    | 750          | 75      | 1000   | 1        | 100,000               | 100    | 0.1      |
| 0.000145 | 0.00001  | 0.00402          | 0.102               | 0.0102              | 0.00232            | 0.00001            | 0.000295 | 0.0075       | 0.00075 | 0.01   | 0.00001  | 1                     | 0.001  | 0.000001 |
| 0.14504  | 0.00987  | 4.019            | 102.07              | 10.207              | 2.321              | 0.0102             | 0.295    | 7.5          | 0.75    | 10     | 0.01     | 1,000                 | 1      | 0.001    |
| 145.04   | 9.869    | 4019             | 102,074             | 10,207              | 2321               | 10.2               | 295.3    | 7500         | 750     | 10,000 | 10       | 1,000,000             | 1,000  | 1        |

To use this chart:

1. Find the column with the units you want to convert from.
2. Move down that column until you find the "1".
3. Staying in the same row, move horizontally to the column with the units you are converting to.
4. Multiply the number in that box by the amount you are changing from to get the converted value.







ISO 9001  
Certified

With almost 70 years of experience, WIKAI Instrument LP is the leading global manufacturer of pressure and temperature measurement instrumentation, producing more than 45 million pressure gauges, diaphragm seals, pressure transmitters, thermometers and other instruments annually. WIKAI's extensive product line, including mechanical and electronic instruments, provides measurement solutions for any application in a large variety of industries.



Industrial Gauge

213.40



All-Welded System

M93X.D1

A global leader in lean manufacturing and instrumentation experience, WIKAI also offers a broad selection of stock and custom instrumentation as well as dedicated services to provide customers with the right solutions, at the right time, wherever they need us.

**WIKAI Instrument LP**  
**Pressure and Temperature Measurement**  
1000 Wiegand Boulevard  
Lawrenceville, GA 30043  
Toll Free 1-888-945-2872  
Tel (770) 513-8200 • Fax (770) 338-5118  
info@wika.com • www.wika.com

PL013 - 5,000 01/13

